

[Rev. 11/21/2013 4:35:10 PM--2013]

[NAC-444 Revised Date: 6-12]

CHAPTER 444 - SANITATION

GENERAL PROVISIONS

[444.0005](#) "Health Division" defined.

STERILIZATION OF USED BEDDING

[444.001](#) Articles requiring sterilization.

[444.002](#) Methods of sterilization.

[444.003](#) Approval of sterilization process: Application; limitations.

[444.004](#) Premises used for sterilization.

[444.005](#) New covering required.

[444.006](#) Permit required to reuse materials obtained from dumps, junkyards or hospitals.

PUBLIC BATHING PLACES

General Provisions

[444.010](#) Definitions.

[444.011](#) "Activity pool" defined.

[444.012](#) "Approved" defined.

[444.013](#) "Artificial swimming lagoon" defined.

[444.015](#) "Child amusement lagoon" defined.

[444.016](#) "Deck" defined.

[444.017](#) "Flume" defined.

[444.020](#) "Health authority" defined.

[444.023](#) "Isolation and flotation tank" defined.

[444.030](#) "Natural bathing place" defined.

[444.040](#) "Normal operating level" defined.

[444.050](#) "Person" defined.

[444.053](#) "Pool" defined.

[444.055](#) "Pool enclosure" defined.

[444.058](#) "Public bathing or swimming facility" defined.

[444.061](#) "Remodel" defined.

[444.064](#) "Slide runoff" defined.

[444.066](#) "Slip resistant" defined.

[444.068](#) "Special purpose pool" defined.

[444.070](#) "Spray pool" defined.

[444.075](#) "Swimming pool" defined.

[444.085](#) "Turnover cycle" defined.

[444.090](#) "Wading pool" defined.

[444.092](#) "Water recreation attraction" defined.

[444.093](#) "Water slide" defined.

[444.094](#) "Watercourse ride" defined.

[444.096](#) "Wave pool" defined.

[444.097](#) Severability.

Preliminary Requirements

[444.100](#) Application; plans and specifications.

[444.102](#) Changes in plans; structural adequacy.

[444.104](#) Inspections.

General Standards for Construction

[444.108](#) Use of equipment and materials not designated by NSF International.

444.110	Location.
444.112	Shape.
444.114	Side walls and bottoms.
444.116	Limitations on depth; signs prohibiting diving.
444.118	Marking depth.
444.120	Slope.
444.122	Diving area and equipment.
444.126	Lifelines.
444.128	Ladders and stairs.
444.130	Handholds.
444.132	Chairs for lifeguards.
444.133	Innovative designs; bridges and walkways.
444.134	Decks.
444.135	Use of manufactured products to resist slipping.
444.136	Barriers; exclusion of unauthorized persons.
444.138	Hose bibs.
444.140	Electrical requirements.
444.142	Lighting.
444.144	Acoustics.
444.146	Connections for supply and disposal of water.
444.148	Quality of water.
444.150	Sampling of water.
444.152	System for recirculation.
444.154	Rate of flow.
444.156	Inlets.
444.158	Drains.
444.160	Piping.
444.162	Pumps and motors.
444.164	Arrangements for overflow.
444.166	Gutters.
444.168	Skimmers.
444.170	Filters.
444.172	Strainers.
444.174	Vacuum cleaners.
444.176	Disposal of waste.
444.178	Disinfectants: Approval of use of chemical feeders and other disinfecting materials and methods.
444.180	Disinfectants: Use of chlorine gas.
444.182	Disinfectants: Handling; storage; toxicity.
444.184	Testing equipment.
444.186	Heating units.
444.188	Equipment rooms.
Water Recreation Attractions	
444.194	Consultation regarding design of attraction.
444.1942	Posting signs indicating maximum depth.
444.1944	Qualifications of attendants.
444.1946	Plan for attendants.
444.1948	Deviation from requirements.
444.195	Water slides: Design and construction.
444.1952	Water slides: Flumes.
444.1954	Water slides: Exit from flume.
444.1956	Water slides: Exit into splash pool.
444.1958	Water slides: Splash pools.
444.196	Water slides: Decks.

- [444.1962](#) Water slides: Means of access.
- [444.1964](#) Water slides: Runouts.
- [444.1966](#) Water slides: Pump reservoirs.
- [444.1968](#) Water slides: Control of water.
- [444.197](#) Water slides: Visitors and spectators.
- [444.1972](#) Water slides: Food and drink; trash.
- [444.1974](#) Water slides: Posting notice of prohibited conduct.
- [444.1976](#) Water slides: Precautions for safety.
- [444.198](#) Activity pools.
- [444.1985](#) Wave pools.
- [444.199](#) Child amusement lagoons.
- [444.1995](#) Watercourse rides.

Miscellaneous Facilities

- [444.200](#) Spray pools.
- [444.202](#) Wading pools: Construction.
- [444.204](#) General requirements for wading pools; location of spray pools.
- [444.206](#) Special purpose pools.
- [444.207](#) Isolation and flotation tanks.
- [444.208](#) Artificial swimming lagoons.

Bathhouses

- [444.210](#) Required facilities.
- [444.212](#) General requirements.
- [444.214](#) Minimum sanitary plumbing facilities.
- [444.216](#) Plumbing requirements.
- [444.218](#) Floors.
- [444.222](#) Furnishings.
- [444.224](#) Entrances and exits.
- [444.226](#) Steps not permitted.
- [444.228](#) Ventilation.

Mineral Baths, Therapeutic Pools and Similar Facilities

- [444.230](#) Applicability.
- [444.232](#) Water quality.
- [444.234](#) Temperature.
- [444.236](#) Required facilities.

Natural Bathing Places

- [444.240](#) Permit required.
- [444.242](#) Standards for approval.
- [444.246](#) Notices and markers.
- [444.248](#) Required facilities.
- [444.250](#) Lifeguards.
- [444.252](#) When bathing prohibited.

Operation

- [444.258](#) Operating permits.
- [444.259](#) Fees for permits and review of plans.
- [444.260](#) Instructions on operation and maintenance of facilities and equipment.
- [444.262](#) Supervision and maintenance of facilities.
- [444.263](#) Use of covers and solar blankets.
- [444.264](#) Records.
- [444.266](#) Lifesaving equipment.
- [444.268](#) Posting information on artificial respiration and emergency services.
- [444.270](#) Presence of lifeguards.
- [444.272](#) Number of lifeguards required.
- [444.274](#) Qualifications, duties and identification of lifeguards.

- [444.276](#) Notices when lifeguards not provided.
- [444.278](#) Capacity.
- [444.280](#) Bathers: Requirements; prohibitions.
- [444.282](#) Bathers: Failure to comply with rules and regulations.
- [444.284](#) Swimming suits and towels.
- [444.286](#) Bathing caps.
- [444.288](#) Food and drinks.
- [444.290](#) Spectators and nonbathers.

Violations

- [444.300](#) Notice of violation.
- [444.302](#) Suspension or denial of operating permit.
- [444.304](#) Order for closure; revocation of suspended permit.
- [444.305](#) Procedure for review of actions taken by Health Division; appeals.
- [444.306](#) Reinspection.

PUBLIC SPAS

General Provisions

- [444.310](#) Definitions.
- [444.315](#) “Air induction system” defined.
- [444.317](#) “Antivortex drain” defined.
- [444.318](#) “Approved” defined.
- [444.320](#) “Bather” defined.
- [444.330](#) “Deck” defined.
- [444.340](#) “Health authority” defined.
- [444.345](#) “Hydrojet” defined.
- [444.347](#) “Hydrojet pump system” defined.
- [444.350](#) “Ladder” defined.
- [444.353](#) “Multiport valve” defined.
- [444.355](#) “Nonslip surface” defined.
- [444.360](#) “NTU” defined.
- [444.365](#) “Overflow system” defined.
- [444.370](#) “Person” defined.
- [444.375](#) “Plastic” defined.
- [444.380](#) “Prefabricated spa” defined.
- [444.385](#) “Public spa” defined.
- [444.390](#) “Ramp” defined.
- [444.395](#) “Recessed steps” defined.
- [444.397](#) “Recessed treads” defined.
- [444.398](#) “Remodel” defined.
- [444.399](#) “Slip resistant” defined.
- [444.400](#) “Spa” defined.
- [444.403](#) “Spa enclosure” defined.
- [444.405](#) “Stairs” defined.
- [444.407](#) “Steps” defined.
- [444.410](#) “Toxic” defined.
- [444.415](#) “Waterline” defined.
- [444.416](#) “Wet deck area” defined.
- [444.417](#) Applicability.
- [444.419](#) Severability.

Preliminary Requirements

- [444.420](#) Application; plans, specifications and descriptive material.
- [444.422](#) Changes in plans; review of plans; structural adequacy.
- [444.424](#) Inspections.

Construction of Spa

444.428	Adoption of Standards by reference.
444.429	Use of equipment and materials not approved by NSF International.
444.430	Shape.
444.432	Depth.
444.434	Depth markings.
444.436	Slope.
444.438	Materials.
444.440	Structural design.
444.442	Steps, ladders, treads and handrails required.
444.444	Spa steps and recessed steps.
444.446	Recessed treads.
444.448	Ladders.
444.450	Handholds.
444.452	Miscellaneous requirements.
444.454	Decks: Dimensional design.
444.456	Decks: Surfaces.
444.458	Hose bibs.
444.460	Drinking fountains.
444.462	Roofs and canopies.
444.463	Enclosures; exclusion of unauthorized persons.
444.465	Gates and doors.
444.466	Electrical requirements.
444.468	When bathhouses required.
444.470	Bathhouse facilities.
444.472	Ventilation.
444.474	Supply of water.
444.476	Quality of water.
444.477	Inlets.
444.480	Drains.
444.482	Piping.
444.484	Circulation and filtration.
444.486	Pumps.
444.488	Pump motors.
444.490	Valves.
444.492	Overflow systems.
444.494	Skimmers.
444.496	Filters.
444.498	Disposal of wastewater.
444.500	Air induction systems.
444.502	Disinfectant required.
444.504	Disinfectants: Approved chemical feeders.
444.506	Disinfectants: Use of chlorine gas.
444.507	Disinfectants: Storage of chlorine gas.
444.508	Disinfectants: Test equipment.
444.510	Heating units.
444.512	Equipment enclosure.
Operation	
444.520	Operating permits.
444.521	Fees for permits and review of plans.
444.522	Records.
444.524	Heater and temperature requirements.
444.526	Safety requirements.
444.528	First aid.

- [444.530](#) Notices which must be posted.
- [444.532](#) Health requirements.
- [444.534](#) Capacity.
- [444.536](#) Visitor and spectator areas; food and drink.

Violations

- [444.540](#) Notice of violation.
- [444.542](#) Suspension or denial of operating permit.
- [444.544](#) Order for closure; revocation of suspended permit.
- [444.545](#) Procedure for review of actions taken by Health Division; appeals.
- [444.546](#) Reinspection.

SANITATION FACILITIES FOR CAMPING SPACES

- [444.5461](#) Definitions.
- [444.54615](#) Severability.
- [444.5462](#) Scope; effect on local standards.
- [444.54625](#) Applicability: Facilities in operation on November 21, 1970; subsequent construction or alteration.
- [444.5463](#) Conformity with requirements; approval for construction; notification of health authority; inspections; permit.
- [444.54635](#) Fees for permits and review of plans.
- [444.5464](#) Location and layout of camping spaces.
- [444.54645](#) Supply of water.
- [444.5465](#) Service buildings; toilets.
- [444.54655](#) Storage, collection and disposal of refuse.
- [444.5466](#) Disposal of sewage; plumbing.
- [444.54665](#) Responsibility for sanitation.
- [444.5467](#) Control of vermin and pets.
- [444.54675](#) Enforcement by health authority; review and appeal of action taken by Health Division.

TEMPORARY MASS GATHERINGS

General Provisions

- [444.547](#) Definitions.
- [444.5471](#) “Food establishment” defined.
- [444.5472](#) “Operator of a temporary mass gathering” defined.
- [444.5473](#) “Potable water” defined.
- [444.5474](#) “Public bathing or swimming facility” defined.
- [444.5475](#) “Public spa” defined.
- [444.5476](#) “Solid waste” defined.
- [444.5477](#) “Temporary food establishment” defined.
- [444.5478](#) “Temporary mass gathering” defined.
- [444.5479](#) “Water station” defined.

Operating Permit

- [444.548](#) Requirement; application; expiration; posting.
- [444.5482](#) Fees.

Standards of Operation

- [444.5484](#) Maintenance of headquarters.
- [444.5486](#) Removal of solid waste.
- [444.5488](#) Operation of food establishment.
- [444.549](#) Provision of potable water; disposal of graywater.
- [444.5492](#) Provision of toilet facilities; removal and disposal of contents of nonsewered toilets.
- [444.5494](#) Discharge of water used to provide dust control.
- [444.5496](#) Operation of public bathing or swimming facility or public spa.

Enforcement

- [444.5498](#) Inspection by health authority.

LABOR CAMPS

- [444.550](#) Applicability.
- [444.552](#) General standards.

444.554	Living and sleeping quarters.
444.556	Cooking and eating facilities.
444.558	Sanitary facilities.
444.560	Laundry facilities.
444.562	Lighting.
444.564	Operating permit: Application; issuance; denial, suspension or revocation.
444.565	Procedure for review of actions taken by Health Division; appeals.
444.566	Fees for permits and review of plans.

SCHOOLS

444.568	Definitions.
444.56802	“Charter school” defined.
444.56804	“Health authority” defined.
444.56806	“Private school” defined.
444.56808	“Public nuisance” defined.
444.5681	“Public school” defined.
444.56812	“School” defined.
444.56814	Severability of provisions.
444.56816	Adoption by reference of certain publications; revision of certain publications after adoption.
444.56818	Submission and approval or denial of plans and specifications for construction.
444.5682	Schools constructed before July 24, 2002.
444.56822	Notification of health authority regarding health or safety hazard.
444.56824	Inspections: Preparation and dissemination of reports by health authority; maintenance of other reports.
444.56826	Correction of deficiencies; reporting of corrective action taken or planned; reporting of noncompliance.
444.56828	Floors, walls and ceilings; benches, mats and other equipment.
444.5683	Lighting.
444.56832	Temperature.
444.56834	Pets.
444.56836	Hazardous materials; laboratories.
444.56838	Materials, tools and other equipment; areas used for teaching vocational education.
444.5684	Areas used for teaching home economics.
444.56842	Health rooms.
444.56844	Electrical panels, janitors’ closets, boiler rooms and storage rooms.
444.56846	Playgrounds and playground equipment.
444.56848	Programs for food service.
444.5685	Water.
444.56852	Sewage.
444.56854	Toilets, lavatories and drinking fountains.
444.56856	Drinking fountains and potable drinking water.
444.56858	Showers and shower fixtures.
444.5686	Garbage and refuse.
444.56862	Control of vermin.

SOLID WASTE DISPOSAL

General Provisions

444.570	Definitions.
444.5701	“Active life” defined.
444.5702	“Administrator” defined.
444.5703	“Appendix I” defined.
444.57035	“Appendix II” defined.
444.5704	“Aquifer” defined.
444.57048	“Cell” defined.
444.5705	“Class I site” defined.
444.571	“Class II site” defined.
444.5715	“Class III site” defined.

444.572	“Composting” defined.
444.573	“Contaminant” defined.
444.5735	“Cross-media” defined.
444.574	“Disposal site” defined.
444.576	“Division” defined.
444.577	“Existing municipal solid waste landfill unit” defined.
444.578	“Garbage” defined.
444.5785	“Gas condensate” defined.
444.579	“Groundwater” defined.
444.580	“Hazardous waste” defined.
444.581	“Household waste” defined.
444.584	“Incinerator” defined.
444.585	“Industrial solid waste” defined.
444.587	“Lateral expansion” defined.
444.5875	“Leachate” defined.
444.588	“Lift” defined.
444.589	“Medical waste” defined.
444.591	“Municipal solid waste landfill unit” defined.
444.592	“Municipality” defined.
444.593	“New municipal solid waste landfill unit” defined.
444.594	“Nuisance” defined.
444.596	“Open burning” defined.
444.598	“Open dump” defined.
444.5985	“Operator” defined.
444.599	“Owner” defined.
444.600	“Pathological wastes” defined.
444.602	“Percolation” defined.
444.604	“Person” defined.
444.605	“Pollutant” defined.
444.6065	“Postclosure” defined.
444.607	“Public waste storage bin facility” defined.
444.608	“Putrescible” defined.
444.609	“Qualified groundwater scientist” defined.
444.610	“Refuse” defined.
444.612	“Rubbish” defined.
444.614	“Salvage yard” defined.
444.616	“Salvaging” defined.
444.620	“Scavenging” defined.
444.622	“Solid waste” defined.
444.624	“Solid waste management authority” defined.
444.626	“Solid waste management system” defined.
444.6265	“Surface impoundment” defined.
444.628	“Transfer station” defined.
444.629	“Uppermost aquifer” defined.
444.630	“Vector” defined.
444.631	“Waters of the State” defined.
444.634	Severability.
444.636	Adoption by reference of certain provisions of Code of Federal Regulations, United States Geological Survey and Environmental Protection Agency.
444.638	Interpretation of provisions.
444.639	Interrelation with other laws and regulations.
Provisions Applicable to Solid Waste Management Systems	
444.640	Open burning; disposal of animal carcasses.

- [444.6405](#) Permit to operate disposal site: Requirement; exemptions; application.
- [444.641](#) Permit to operate disposal site: Evaluation of application; notice to applicant concerning completeness and compliance; notice of intent to issue or deny application; period for public comment.
- [444.6415](#) Permit to operate disposal site: Response to notice of intent to issue or deny application; request for public hearing; notice of public hearing.
- [444.6419](#) Permit to operate disposal site: Response by solid waste management authority to written comments concerning proposed issuance or denial of permit; publication of written comments.
- [444.6425](#) Permit to operate disposal site: Duties of solid waste management authority after period for public review; modification or placement of conditions based on public comments.
- [444.643](#) Permit to operate disposal site: Issuance; revocation or suspension; requirements for transfer to subsequent owner or operator.
- [444.6435](#) Permit to operate disposal site: Request for modification; conditions requiring public notice and review.
- [444.644](#) Systems for solid waste.
- [444.645](#) Program for quality assurance and control for construction of required liner system.
- [444.646](#) Disposal of special wastes: Sewage sludge, septic tank pumpings and medical wastes; coverage of burial area.
- [444.648](#) Disposal of special wastes: Waste tires.
- [444.650](#) Disposal of special wastes: Waste oils.
- [444.652](#) Disposal of special wastes: Construction and demolition wastes.
- [444.654](#) Disposal of special wastes: Septic tank pumpings and raw sewage.
- [444.656](#) Disposal of special wastes: Untreated sewage sludge.
- [444.658](#) Plans to manage solid waste.
- [444.660](#) Standards for storage, collection and transportation set by ordinances.
- [444.662](#) Storage of solid wastes before collection.
- [444.664](#) Collection and transportation of solid wastes.
- [444.666](#) Transfer stations: Design and operating plans.
- [444.6661](#) Transfer stations: Application to operate or modify.
- [444.6662](#) Transfer stations: Contents of report concerning design.
- [444.6663](#) Transfer stations: Requirements for operating plan.
- [444.6664](#) Transfer stations: Construction.
- [444.66645](#) Transfer stations: Handling and salvage of solid waste; maintenance of records; handling of asbestos; removal of remaining waste at final closure.
- [444.66647](#) Public waste storage bin facility: Notification of establishment; general requirements; final closure.
- [444.6665](#) Operating criteria: Program for detecting and preventing disposal of regulated hazardous waste and PCB wastes.
- [444.667](#) Operating criteria: Control of explosive gas.
- [444.6675](#) Operating criteria: Compliance with state implementation plan; open burning of certain solid wastes prohibited.
- [444.6678](#) Operating criteria: Vector control.
- [444.668](#) System to process waste: Hazards, nuisances and impairment of environment prohibited.
- [444.670](#) System to process waste: Compost plant.
- [444.672](#) System to process waste: Incineration.
- [444.674](#) System to process waste: Salvage yard.
- [444.676](#) System to process waste: Other methods.
- [444.6765](#) Closure of existing municipal solid waste landfill unit for failure to prove compliance with certain provisions.

Class I Sites

- [444.6769](#) Minimum requirements.
- [444.677](#) Application for permit to operate Class I site or lateral expansion thereof.
- [444.678](#) Location restrictions: Generally.
- [444.6783](#) Location restrictions: Airport safety.
- [444.6785](#) Location restrictions: Floodplains.
- [444.679](#) Location restrictions: Wetlands.
- [444.6791](#) Location restrictions: Fault areas.
- [444.6793](#) Location restrictions: Seismic impact zones.
- [444.6795](#) Location restrictions: Unstable areas.
- [444.680](#) Report of design.

444.681	Design criteria.
444.683	Plan for monitoring water; suspension of monitoring requirements.
444.6835	Schedule for compliance with monitoring requirements.
444.684	Plan for operating.
444.685	Financial assurance: Compliance mandatory; exemptions; waiver.
444.6851	Financial assurance: Estimate for cost of plan for closure; adjustments to estimate.
444.68515	Financial assurance: Estimate for cost of program for postclosure; adjustments to estimate.
444.6852	Financial assurance: Estimate for cost of plan for corrective action; adjustments to estimate.
444.68525	Financial assurance: Allowable mechanisms.
444.6853	Financial assurance: Trust fund.
444.68535	Financial assurance: Surety bond guaranteeing payment or performance.
444.6854	Financial assurance: Letter of credit.
444.6855	Financial assurance: Insurance.
444.6856	Financial assurance: Alternate mechanisms approved by solid waste management authority.
444.6857	Financial assurance: Assumption of responsibility by State.
444.6858	Financial assurance: Use of multiple mechanisms.
444.6859	Financial assurance: General requirements for all mechanisms.
444.686	Operation and maintenance.
444.688	Covering of compacted solid waste; continuous operation as alternative.
444.6885	System to control runoff and runoff.
444.6887	Discharge of pollutants or contaminants into surface waters prohibited.
444.6891	Requirements for design and construction of system for final cover.
444.6892	Notice of intent to close; general requirements concerning closure.
444.6893	Requirements after closure of all municipal solid waste landfill units within Class I site.
444.6894	Program for postclosure for each municipal solid waste landfill unit within Class I site.
444.6895	Plan for final cover or closure of Class I site.
444.6896	Plan for postclosure; use of property during or after period of postclosure.
444.6897	Maintenance of plans for closure and postclosure in operating records of site.
444.690	Signs.
444.692	Disposal of liquids.
444.694	Putrescible wastes; vector control.
444.696	Control of erosion and dust.
444.698	Access; roads.
444.700	Facilities for personnel.
444.702	Miscellaneous requirements for operation; quarterly reports; topographic or other volumetric surveys and reports.
444.7025	Operating records required to be kept; notice to solid waste management authority.

Class II Sites

444.704	Minimum requirements; operating records; contamination of groundwater.
444.7045	Provisions for employees; compliance with certain provisions; deviations.
444.705	Application for permit to operate Class II site or lateral expansion thereof.
444.706	Location.
444.708	Report for design.
444.711	Required installation of certain systems.
444.712	Plan for operating.
444.714	Operation and maintenance.
444.716	Cover of solid wastes.
444.7175	Final cover and closure for certain sites; deviations.
444.718	Signs.
444.720	Disposal of special wastes.
444.722	Putrescible wastes; vector control.
444.724	Control of erosion and dust.
444.726	Roads.
444.728	Miscellaneous requirements for operation; semiannual reports; topographic or other volumetric surveys and

reports.

Class III Sites

- [444.731](#) Minimum standards; reduction or waiver of requirements.
- [444.733](#) Application for permit to operate Class III site or lateral expansion thereof.
- [444.735](#) Location.
- [444.737](#) Plan to characterize solid waste.
- [444.739](#) Report for design.
- [444.741](#) Plan for monitoring water; suspension of monitoring requirements.
- [444.743](#) Final cover or closure; postclosure.
- [444.745](#) Control of erosion and dust.
- [444.747](#) Miscellaneous requirements; reports; records; notification.

Materials Recovery Facilities

- [444.7474](#) “Materials recovery facility” defined.
- [444.74743](#) Approval needed for operation; submission of application before construction begins.
- [444.74747](#) Application to operate; application to modify.
- [444.74751](#) Report of design.
- [444.74755](#) Plan for operating.
- [444.74759](#) Standards for design.
- [444.74763](#) Transfer, removal, recovery and storage of solid waste.
- [444.74767](#) Maintenance, availability and content of records; classification of certain information as trade secret; reporting of recycled materials.
- [444.74771](#) Closure of facility.
- [444.74775](#) Surety bond or other financial assurance required to cover cost of closure.
- [444.74779](#) Compliance with plans for design and operation; suspension or revocation of approval to operate.

Appeals and Requests for Variance

- [444.748](#) Petition for variance; appeals.

Groundwater Monitoring and Corrective Action

- [444.7481](#) Suspension and continuation of monitoring requirements.
- [444.7482](#) Alternative schedule for complying with monitoring requirements.
- [444.7483](#) Requirements concerning system for monitoring groundwater.
- [444.7484](#) Program for sampling and analysis.
- [444.7485](#) Statistical methods for evaluating data; performance standards.
- [444.7486](#) Determination of statistically significant increase over background values.
- [444.7487](#) Constituents required to be monitored; establishment of list of alternative parameters for inorganic materials.
- [444.7488](#) Program for detection monitoring.
- [444.7489](#) Procedures upon determination of statistically significant increase of Appendix I constituents or alternative parameters.
- [444.749](#) Program for assessment monitoring.
- [444.7491](#) Procedures upon determination of concentrations of Appendix II constituents.
- [444.7492](#) Establishment of standard for protection of groundwater.
- [444.7493](#) Assessment of corrective measures upon determination that level of any Appendix II constituent exceeds standard for protection of groundwater; public notice and comment.
- [444.7494](#) Selection and approval of remedy by solid waste management authority.
- [444.7495](#) Schedule for initiation and completion of remedial activities.
- [444.7496](#) Exemptions from requirement of remediation.
- [444.7497](#) Program for monitoring corrective action; performance of remedial activities; interim measures to protect public.
- [444.7498](#) Ineffectiveness of selected remedy; impracticability of currently available methods of remediation.
- [444.7499](#) Remedy deemed complete; certification of completion.

SEWAGE DISPOSAL

General Provisions

- [444.750](#) Definitions.
- [444.7502](#) “Absorption trench” defined.
- [444.7503](#) “Accessory structure” defined.

444.7504	“Administrative authority” defined.
444.7506	“Aerobic wastewater treatment unit” defined.
444.7508	“Aggregate” defined.
444.751	“Alternative absorption system” defined.
444.7512	“Alternative treatment system” defined.
444.7514	“Approved method of sewage disposal” defined.
444.7516	“Approved service provider” defined.
444.7522	“Backflow” defined.
444.7524	“Basal area” defined.
444.7525	“Bathroom unit” defined.
444.7528	“Building drain” defined.
444.753	“Building sewer” defined.
444.7536	“Capping fill trench” defined.
444.754	“Cesspool” defined.
444.755	“Commercial system” defined.
444.758	“Distribution box” defined.
444.759	“Domestic sewage” defined.
444.760	“Dosing tank” defined.
444.7603	“Drainage channel” defined.
444.7606	“Effluent” defined.
444.7608	“Elevated mound system” defined.
444.761	“Engineer” defined.
444.7616	“Graywater” defined.
444.762	“Health authority” defined.
444.7624	“Holding tank” defined.
444.763	“Impervious soil” defined.
444.764	“Individual sewage disposal system” defined.
444.7642	“Irrigation ditch” defined.
444.7644	“Kitchen unit” defined.
444.7646	“Lot” defined.
444.765	“Multiple-dwelling structure” defined.
444.7652	“Nitrogen removal wastewater treatment unit” defined.
444.7654	“Nonsewered toilet” defined.
444.7656	“Percolation rate” defined.
444.7658	“Percolation test” defined.
444.766	“Person” defined.
444.7664	“Potable water” defined.
444.7666	“Pressure distribution system” defined.
444.7668	“Primary treatment unit” defined.
444.767	“Residential system” defined.
444.768	“Septic tank” defined.
444.770	“Septic tank pumping contractor” defined.
444.772	“Sewage” defined.
444.775	“Single-family dwelling” defined.
444.776	“Soil absorption system” defined.
444.7764	“Special event” defined.
444.777	“Watercourse” defined.
444.7772	“Water table” defined.
444.778	Purpose.
444.780	Interpretation.
444.782	Severability.
444.7825	Adoption by reference of certain publications; revision of certain publications after adoption.
444.783	Approval of alternate methods of compliance.

Individual Sewage Disposal Systems

- [444.784](#) Permits: Approval for new construction required; request for approval; nature and duration.
- [444.786](#) Permits: Denials; procedure for review of actions taken by health authority; appeals; validity and extension.
- [444.788](#) Inspections.
- [444.790](#) Lot size.
- [444.792](#) Location.
- [444.794](#) Slope requirements.
- [444.796](#) Performance of percolation test by property owner; verification of certain data by engineer.
- [444.7962](#) Determination of appropriate percolation test procedure.
- [444.7964](#) Fast percolation test procedure.
- [444.7966](#) Presoaking procedure for slow percolation test.
- [444.7968](#) Slow percolation test procedure.
- [444.797](#) Sample form for percolation test.
- [444.7972](#) Sample log for profile of soil.
- [444.798](#) Approved cleanout; building sewer.
- [444.804](#) Construction of septic tank.
- [444.806](#) Precast septic tanks.
- [444.808](#) Built-in-place septic tanks.
- [444.810](#) Coated steel septic tanks.
- [444.815](#) Plumbing accessory structure into system serving single-family dwelling.
- [444.818](#) Limitations and site requirements.

Septic Tank Pumping Contractors

- [444.820](#) General requirements for and restrictions on operation.
- [444.821](#) Permit: Contents; validity and transferability.
- [444.822](#) Permit: Conditions that require amendment.
- [444.823](#) Permit: Renewal.
- [444.824](#) Recordkeeping requirements.

Nonsewered Toilets

- [444.825](#) Toilet facilities for special events.
- [444.826](#) General requirements.

Fees

- [444.828](#) Schedule of fees.

Discharge and Treatment of Liquid Waste and Wastewater

- [444.8301](#) General requirements for primary treatment unit; use of alternative treatment system.
- [444.8302](#) Plans for commercial systems to be submitted for review.
- [444.8304](#) General requirements for septic tank used as primary treatment unit or with alternative treatment system.
- [444.8306](#) Capacity of septic tank serving single-family dwelling.
- [444.8314](#) Aerobic wastewater treatment unit: Maintenance; repair or replacement; required use.
- [444.8316](#) Aerobic wastewater treatment unit: Approval required; design criteria; limitations on use; manual of operation and maintenance.
- [444.8318](#) Aerobic wastewater treatment unit: Inspection.
- [444.8321](#) Nitrogen removal wastewater treatment unit: Maintenance; repair or replacement; required use; regulatory oversight program.
- [444.8322](#) Nitrogen removal wastewater treatment unit: Approval required; design criteria; limitations on use; manual of operation and maintenance.
- [444.8324](#) Nitrogen removal wastewater treatment unit: Inspection.
- [444.8326](#) Dosing tank: General requirements.
- [444.8328](#) Dosing tank: Design criteria.
- [444.833](#) Distribution box: General requirement; design criteria.

Absorption and Treatment of Effluent

- [444.835](#) Soil absorption system: General requirements.
- [444.8352](#) Absorption trench system: General requirements; design calculations.
- [444.8354](#) Absorption trench system: Design criteria.

444.8356	Absorption trench system: Inspections.
444.8358	Absorption bed: General requirements.
444.8361	Absorption bed: Design criteria.
444.8362	Absorption bed: Inspections.
444.8364	Chamber system: General requirements.
444.8366	Chamber system: Design criteria.
444.8368	Chamber system: Inspections.
444.837	System utilizing graywater for underground irrigation: General requirements.
444.8372	System utilizing graywater for underground irrigation: Application to construct, alter or install system; design criteria.
444.8374	Alternative absorption system: General requirements.
444.8376	Stepped network of trenches utilizing relief lines: General requirements.
444.8378	Stepped network of trenches utilizing relief lines: Design criteria.
444.8381	Stepped network of trenches utilizing relief lines: Inspections.
444.8382	Capping fill trench: General requirements.
444.8384	Capping fill trench: Design criteria.
444.8386	Capping fill trench: Inspections.
444.8388	Elevated mound system: General requirements.
444.839	Elevated mound system: Design criteria.
444.8392	Elevated mound system: Inspections.
444.8394	Pressure distribution system: General requirements.
444.8396	Pressure distribution system: Design criteria.

FACILITIES FOR MANAGEMENT OF HAZARDOUS WASTE

General Provisions

444.842	Definitions.
444.8422	“Administrator” defined.
444.84225	“Class 3 modification” defined.
444.8423	“Commission” defined.
444.84235	“Delisted waste” defined.
444.8424	“Disposal” defined.
444.8426	“Division” defined.
444.8427	“Facility for community recycling” defined.
444.84275	“Facility for community storage” defined.
444.8428	“Facility for the management of hazardous waste” defined.
444.84285	“Facility for the recycling of hazardous waste” defined.
444.843	“Hazardous waste” defined.
444.8432	“Management of hazardous waste” defined.
444.8433	“Mobile unit for the recycling of hazardous waste” defined.
444.84335	“New or expanding facility for the management of hazardous waste” defined.
444.8434	“Person” defined.
444.8436	“Polychlorinated biphenyl” defined.
444.8437	“Recycling” defined.
444.84375	“Remediation waste” defined.
444.8438	“Storage” defined.
444.8442	“Treatment” defined.
444.8444	“Waste containing polychlorinated biphenyl” defined.
444.8446	Fee for processing and review of certain applications: Payment; amount; deposit; return of excess.
444.8447	Fees for emergency permit.
444.8448	Fees for modification, termination or reissuance of existing permit.
444.845	Annual operating fee; penalty for unpaid fee.
444.8452	Additional fees to offset cost of inspection and other regulation: Payment; accounting; penalty for unpaid fee; waiver.
444.8454	Deposit of fees.

- [444.8455](#) Facility or mobile unit for recycling of hazardous waste: Preliminary requirements; exemption.
- [444.84555](#) Facility or mobile unit for recycling of hazardous waste: Written determination by Administrator.
- [444.8456](#) Stationary new or expanding facility for management of hazardous waste: Restrictions on location; exempt facilities.
- [444.8458](#) Stationary new or expanding facility for management of hazardous waste: Certificate of designation; prerequisite for permit; application; issuance; exempt facilities.
- [444.846](#) Fee for volume of hazardous waste received by facility for the management of hazardous waste owned by State: Amount; payment; penalty; disposition.

Variations

- [444.847](#) Submission of application.
- [444.8472](#) Contents of application.
- [444.8474](#) Fee for review of application: Amount; return of excess.
- [444.8476](#) Initial review of application; recommendation to Commission.
- [444.8478](#) Public comment and hearing on application; statement of reasons for denial.
- [444.848](#) Duration of variance; revocation; annual review.
- [444.8482](#) Renewal of variance.

DISPOSAL OF HAZARDOUS WASTE

General Provisions

- [444.850](#) Definitions.
- [444.8505](#) “Administrator” defined.
- [444.8508](#) “Commission” defined.
- [444.8509](#) “Conditionally exempt small quantity generator” defined.
- [444.851](#) “Department” defined.
- [444.8515](#) “Director” defined.
- [444.853](#) “Division” defined.
- [444.8546](#) “Facility for the management of hazardous waste” defined.
- [444.8565](#) “Hazardous waste” defined.
- [444.861](#) “Used oil” defined.
- [444.8618](#) Information concerning and application for EPA identification number.

Standards of Practice

- [444.8632](#) Compliance with federal regulations adopted by reference.
- [444.86325](#) Exceptions to and revision of federal regulations adopted by reference.
- [444.8633](#) Revision of certain terms referred to in federal regulations adopted by reference.
- [444.8634](#) Meanings ascribed to certain terms referred to in federal regulations; payment and deposit of certain fees.
- [444.8655](#) Acquisition, preparation and distribution of manifests.
- [444.8666](#) Receipt of hazardous waste accompanied by manifest.
- [444.8671](#) Labeling of containers of hazardous waste accumulated or stored on-site.
- [444.8677](#) Written record of inspections by certain generators of hazardous waste.
- [444.8681](#) Mixing of used oil with hazardous waste or products prohibited; exceptions; recordkeeping requirements.
- [444.8682](#) Requirements for managing and disposing of mixtures of used oil and hazardous wastes or other products.
- [444.8683](#) Regulation of mixtures of used oil with wastes determined not to be hazardous.
- [444.8686](#) Open burning of hazardous waste.
- [444.8688](#) Transfer of hazardous waste from transport vehicle to boiler or industrial furnace.

Variations

- [444.8693](#) Submission of application for variance from certain federal regulations.
- [444.8696](#) Fee for processing and review of application for variance.

Administrative Penalties

- [444.8701](#) Definitions.
- [444.8706](#) Imposition and amounts.
- [444.8711](#) Issuance and contents of citations.
- [444.8716](#) Requests for forfeiture or hearing; scheduling and notice of hearing.
- [444.8721](#) Failure to request forfeiture or hearing or to appear at hearing.
- [444.8726](#) Continuance of hearing.

- [444.8731](#) Inspection and copying of documents Division intends to use at hearing.
- [444.8736](#) Rendering of decision by hearing officer.
- [444.8741](#) Address for delivery of documents.
- [444.8746](#) Methods of payment.

RECYCLING OF USED ANTIFREEZE

General Provisions

- [444.8801](#) Definitions.
- [444.8806](#) “Administrator” defined.
- [444.8811](#) “Center for the collection of used antifreeze” defined.
- [444.8816](#) “Commission” defined.
- [444.8821](#) “Division” defined.
- [444.8826](#) “Facility for the recycling of used antifreeze” defined.
- [444.8831](#) “Facility for the transfer of used antifreeze” defined.
- [444.8836](#) “Generator of used antifreeze” defined.
- [444.8841](#) “Hazardous waste” defined.
- [444.8846](#) “Identification number” defined.
- [444.8851](#) “Mobile unit for the recycling of used antifreeze” defined.
- [444.8856](#) “Point for aggregation” defined.
- [444.8861](#) “Transporter of used antifreeze” defined.
- [444.8866](#) “Used antifreeze” defined.
- [444.8871](#) Applicability.

General Requirements

- [444.8876](#) Containers and tanks for storage of used antifreeze: General requirements.
- [444.8881](#) Underground storage tanks: Compliance with federal regulations; identification of pipes.
- [444.8886](#) Container: Secondary system for containment.
- [444.8891](#) Above-ground storage tank: Secondary system for containment.
- [444.8896](#) Required action upon release of used antifreeze.
- [444.8901](#) Required report of release of used antifreeze.
- [444.8906](#) Required report of release of used antifreeze into body of water.

Generation, Collection and Aggregation

- [444.8911](#) Applicability.
- [444.8916](#) Mixing of used antifreeze with solid or hazardous waste forbidden; storage.
- [444.8921](#) Center for collection of used antifreeze: Registration.
- [444.8926](#) Recycling of used antifreeze for personal use: Requirements; calculation in determination of status; management of waste as hazardous waste.
- [444.8931](#) Transport of used antifreeze: Responsibilities of generator; calculation in determination of status.

Transport and Transfer

- [444.8936](#) Applicability.
- [444.8941](#) Management of used antifreeze transported in truck used for hazardous waste.
- [444.8946](#) Consolidation or aggregation; processing forbidden; exception.
- [444.8951](#) Identification number; compliance with federal regulations.
- [444.8956](#) Required destinations after transport.
- [444.8961](#) Records of used antifreeze accepted for transport: Maintenance; contents.
- [444.8966](#) Records of used antifreeze delivered to transporter: Maintenance; contents.
- [444.8971](#) Release of used antifreeze during transport.
- [444.8976](#) Release of used antifreeze into body of water during transport.
- [444.8981](#) Storage: Tanks and containers.
- [444.8986](#) Storage: Maximum duration.

Facilities for Recycling

- [444.8991](#) Applicability.
- [444.8996](#) Written determination; identification number.
- [444.9001](#) Storage: Tanks and containers.
- [444.9006](#) Requirements when above-ground storage tank no longer used.

- [444.9011](#) Requirements when facility is closed.
- [444.9016](#) Records of used antifreeze accepted by facility: Maintenance; contents.
- [444.9021](#) Management of residue as hazardous waste.
- [444.9026](#) Responsibility of owner or operator that used antifreeze not be mixed with hazardous waste; creation, maintenance and review of written plan.
- [444.9031](#) Contingency plan in case of release: Contents; review and amendment; maintenance.
- [444.9036](#) Responsibility of owner or operator for weekly inspection of storage tanks and containers.
- [444.9041](#) Written record of operation.
- [444.9046](#) Written report.

Mobile Units for Recycling

- [444.9051](#) Applicability.
- [444.9056](#) Written determination.
- [444.9061](#) Records of used antifreeze accepted by mobile unit: Maintenance; contents.
- [444.9066](#) Management of residue as hazardous waste.
- [444.9071](#) Written report.

POLYCHLORINATED BIPHENYL

- [444.940](#) Definitions.
- [444.9405](#) “Director” defined.
- [444.941](#) “Disposal” defined.
- [444.9415](#) “Division” defined.
- [444.942](#) “Draft permit” defined.
- [444.9425](#) “Facility for the management of waste containing polychlorinated biphenyl” defined.
- [444.943](#) “Generator of polychlorinated biphenyl” defined.
- [444.9435](#) “Polychlorinated biphenyl” defined.
- [444.944](#) “Site” defined.
- [444.9445](#) “Storage” defined.
- [444.945](#) “Waste containing polychlorinated biphenyl” defined.
- [444.9452](#) Adoption by reference of certain federal regulations.
- [444.9453](#) References in federal regulations to “hazardous waste” and “hazardous waste facility.”
- [444.946](#) Generators: General duties.
- [444.9465](#) Transporters: General duties.
- [444.9475](#) Restrictions on management and treatment.
- [444.9485](#) Requirements for permit to operate or construct facility; requirements for permitted facility.
- [444.949](#) Director to prepare draft permit or deny application.
- [444.9495](#) Public notice.
- [444.950](#) Public comment and hearings.
- [444.9505](#) Final decision by Director.
- [444.951](#) Requirements specified in permit.
- [444.9515](#) Transfer of permit.
- [444.952](#) Modification of permit; revocation and reissuance.
- [444.9525](#) Notice of intent to terminate permit.
- [444.953](#) Emergency permits.
- [444.9535](#) Notice of planned alterations or additions.
- [444.954](#) Report of noncompliance.
- [444.9545](#) Completion or correction of application or report.
- [444.955](#) Minor modifications to permit.
- [444.9555](#) Facilities to obtain identification number; compliance with regulations.

LIMITATIONS ON ISSUANCE OF PERMITS

- [444.960](#) Reliability, expertise and competence required; issuance prohibited if person having beneficial interest convicted of felony.

DISPOSAL OF ASBESTOS

- [444.965](#) Definitions.
- [444.966](#) “Asbestos” defined.

444.967	“Division” defined.
444.968	“Operator” defined.
444.969	“Solid waste management authority” defined.
444.970	“Transporter” defined.
444.971	Standards for handling and transportation.
444.972	Approval required for transportation; submission of information to obtain approval.
444.973	Maintenance and filing of records regarding transportation.
444.974	Notification required before delivery; disposal at site other than Class I disposal site.
444.975	Inspection upon delivery; notice of noncompliance with standards; acceptance of noncomplying load.
444.976	Duties of operator who accepts asbestos.

PRACTICE BEFORE STATE ENVIRONMENTAL COMMISSION

444.980	Appeal of final decision of State Department of Conservation and Natural Resources.
-------------------------	---

GENERAL PROVISIONS

NAC 444.0005 “Health Division” defined. ([NRS 439.200](#)) As used in this chapter, unless the context otherwise requires, “Health Division” means the Health Division of the Department of Health and Human Services.

(Added to NAC by Bd. of Health, eff. 10-30-97; A by R177-99, 7-24-2002)

STERILIZATION OF USED BEDDING

NAC 444.001 Articles requiring sterilization. ([NRS 439.200](#), [444.020](#)) Used or secondhand articles of bedding requiring sterilization or disinfection are:

1. Quilted pads.
2. Bunk quilts.
3. Comforters.
4. Mattresses.
5. Mattress pads.
6. Cushions.
7. Pillows.
8. Sheets.
9. Blankets.
10. Any other contaminated or soiled article of bedding.
11. Materials used in the filling of any of the above or similar articles.

[Bd. of Health, Used Bedding Reg. No. 1, eff. 7-16-45]

NAC 444.002 Methods of sterilization. ([NRS 439.200](#), [444.020](#)) Sterilization or disinfection of used or secondhand articles listed in [NAC 444.001](#) must be by one of the following methods, under the conditions outlined:

1. By thorough washing and sterilization by prolonged boiling for at least 1 hour.
2. By steam under 15 pounds pressure for at least 30 minutes. A gauge for registering steam pressure, visible from the outside of the room, must be provided where steam under pressure is used.
3. Two applications of streaming steam maintained for a period of 1 hour each to be applied at intervals of not less than 6 hours or more than 24 hours will be accepted as an alternate for steam under pressure for disinfection of mattress materials or made-up mattresses. When streaming steam is employed, valved outlets must be provided near the bottom and top of the room used for this purpose.

4. By application of a chemical pesticide registered with or exempted by the United States Environmental Protection Agency and registered with the State Department of Agriculture. The chemical pesticide must:

- (a) Have clearly stated on the label, or on printed matter included in each container or package, detailed

instructions for its use in disinfecting used or secondhand articles;

(b) Have clearly stated on the label a statement that the pesticide is safe to use on bedding; and

(c) Be applied in a manner which ensures that the used or secondhand articles are disinfected.

5. By a method approved by a local health authority in areas where the laws and regulations governing sterilization of used bedding are administered by local health authorities.

[Bd. of Health, Used Bedding Reg. No. 2, eff. 7-16-45]—(NAC A by R100-07, 10-31-2007)

NAC 444.003 Approval of sterilization process: Application; limitations. ([NRS 439.200](#), [444.020](#))

1. Before engaging in any of the processes described in [NAC 444.002](#), application must be made to the State Health Officer or his or her authorized agents, designating the process which will be employed. The fumigating room must be approved by the State Health Officer or his or her authorized agents.

2. In making application for approval of a sterilization plant, a complete statement must be made of the method to be employed for disinfection and this statement must be accompanied by a plan in duplicate drawn to scale showing details of the installation. This plan must bear a title indicating clearly where the installation is to be made, the scale of the drawing, and be signed by the applicant.

3. No approval will be issued for a period longer than 1 year. Approval is revocable at any time without notice if the manufacturer is not carrying on the disinfection process in accordance with the spirit and purpose of the law.

[Bd. of Health, Used Bedding Reg. Nos. 3-5, eff. 7-16-45]

NAC 444.004 Premises used for sterilization. ([NRS 439.200](#), [444.020](#)) All premises, rooms, chambers, and devices used for the purpose of sterilization or disinfection must be kept in a clean and orderly condition, free from accumulated dust, dirt and other filth, and must be kept free of vermin.

[Bd. of Health, Used Bedding Reg. No. 7, eff. 7-16-45]

NAC 444.005 New covering required. ([NRS 439.200](#), [444.020](#)) Filthy or soiled articles of bedding are not considered properly sterilized or disinfected unless the fabric covering the articles is laundered or replaced by a clean or new covering and the filling material subjected to one of the sterilizing methods outlined in [NAC 444.002](#).

[Bd. of Health, Used Bedding Reg. No. 6, eff. 7-16-45]

NAC 444.006 Permit required to reuse materials obtained from dumps, junkyards or hospitals. ([NRS 439.200](#), [444.020](#)) No articles or materials obtained from public dump grounds, junkyards or hospitals may be reused in the manufacturing, making or renovating of mattresses, bed coverings, pillows, cushions or any other similar bedding that may be used for sleeping purposes unless a special permit is obtained from the State Health Officer or his or her authorized agents.

[Bd. of Health, Used Bedding Reg. No. 8, eff. 7-16-45]

PUBLIC BATHING PLACES

General Provisions

NAC 444.010 Definitions. ([NRS 439.200](#), [444.070](#)) As used in [NAC 444.010](#) to [444.306](#), inclusive, unless the context otherwise requires, the words and terms defined in [NAC 444.011](#) to [444.096](#), inclusive, have the meanings ascribed to them in those sections.

(Supplied in codification; A by Bd. of Health, 11-1-88; 10-30-97)

NAC 444.011 “Activity pool” defined. ([NRS 439.200](#), [444.070](#)) “Activity pool” means a water recreation attraction that has water-related activities such as rope ladders, rope swings, cargo nets and other similar activities designed primarily for bathers other than small children.

(Added to NAC by Bd. of Health, eff. 11-1-88)

NAC 444.012 “Approved” defined. ([NRS 439.200](#), [444.070](#)) “Approved” means acceptable to the

health authority based upon a determination concerning conformance with appropriate standards and good public health practices.

(Added to NAC by Bd. of Health, eff. 11-1-88)

NAC 444.013 “Artificial swimming lagoon” defined. ([NRS 439.200](#), [444.070](#)) “Artificial swimming lagoon” means an artificial body of water with more than 20,000 square feet of water surface area that is intended to be used by persons for swimming or bathing and that is constructed with special features to imitate a natural bathing place.

(Added to NAC by Bd. of Health, eff. 11-1-88)

NAC 444.015 “Child amusement lagoon” defined. ([NRS 439.200](#), [444.070](#)) “Child amusement lagoon” means a water recreation attraction that has water-related activities such as small slides, shallow pools, children washes and other similar activities designed primarily for use by small children.

(Added to NAC by Bd. of Health, eff. 11-1-88)

NAC 444.016 “Deck” defined. ([NRS 439.200](#), [444.070](#)) “Deck” means the area around the perimeter of a public bathing or swimming facility, adjacent to the water, that is used primarily by bathers.

(Added to NAC by Bd. of Health, eff. 11-1-88)

NAC 444.017 “Flume” defined. ([NRS 439.200](#), [444.070](#)) “Flume” means a device designed to provide a descending ride into a splash pool or slide runout at the base of a water slide. Friction on the bed of the flume is minimized in all designs by providing a flowing film of water.

(Added to NAC by Bd. of Health, eff. 11-1-88)

NAC 444.020 “Health authority” defined. ([NRS 439.200](#), [444.070](#)) “Health authority” means officers and agents of the Health Division or the local boards of health.

[Bd. of Health, Public Bathing Places Reg. Art. 1 § 1.2, eff. 5-21-74]

NAC 444.023 “Isolation and flotation tank” defined. ([NRS 439.200](#), [444.070](#)) “Isolation and flotation tank” means a tank that:

1. Provides a light- and sound-free environment; and
2. Contains a saturated solution of sodium chloride or magnesium sulfate having a specific gravity of 1.27 to 1.3 and maintained at a temperature of approximately 93.5°F (34.1°C).

(Added to NAC by Bd. of Health, eff. 11-1-88)

NAC 444.030 “Natural bathing place” defined. ([NRS 439.200](#), [444.070](#)) “Natural bathing place” means any bathing place at a lake, pond, stream or similar body of water, together with any buildings and appurtenances:

1. Used by the public for bathing or swimming with the express permission of the lessee or any person responsible for the premises; or
2. Openly advertised as a place for bathing or swimming by the public.

[Bd. of Health, Public Bathing Places Reg. Art. 1 § 1.3, eff. 5-21-74]

NAC 444.040 “Normal operating level” defined. ([NRS 439.200](#), [444.070](#)) “Normal operating level” means the overflow point on overflow gutters or the midpoint in the throat of the skimmers.

[Bd. of Health, Public Bathing Places Reg. Art. 1 § 1.9, eff. 5-21-74]

NAC 444.050 “Person” defined. ([NRS 439.200](#), [444.070](#)) “Person” includes governmental agencies.

[Bd. of Health, Public Bathing Places Reg. Art. 1 § 1.1, eff. 5-21-74]

NAC 444.053 “Pool” defined. ([NRS 439.200](#), [444.070](#)) “Pool” means any swimming pool or any structure within a public bathing or swimming facility containing an artificial body of water.

(Added to NAC by Bd. of Health, eff. 11-1-88)

NAC 444.055 “Pool enclosure” defined. ([NRS 439.200](#), [444.070](#)) “Pool enclosure” means the area inside of the fence or barrier surrounding a public bathing or swimming facility.
[Bd. of Health, Public Bathing Places Reg. Art. 1 § 1.6, eff. 5-21-74]—(NAC A 11-1-88)

NAC 444.058 “Public bathing or swimming facility” defined. ([NRS 439.200](#), [444.070](#))

1. “Public bathing or swimming facility” means any:

- (a) Artificial swimming lagoon;
- (b) Isolation and flotation tank;
- (c) Mineral bath, therapeutic pool or similar facility;
- (d) Special purpose pool;
- (e) Spray pool;
- (f) Swimming pool;
- (g) Wading pool; or
- (h) Water recreation attraction,

Ê that is used by the public for swimming or bathing.

2. The term does not include any facility at a private residence controlled by the owner of the residence, the use of which is limited to members of the family or invited guests of the owner.

(Added to NAC by Bd. of Health, eff. 11-1-88)

NAC 444.061 “Remodel” defined. ([NRS 439.200](#), [444.070](#))

1. “Remodel” means to replace all or part of any structure, circulation system or appurtenance of a public bathing or swimming facility or to modify it to the extent that its design, configuration or operating characteristics differ in any respect from those of the original.

2. The term does not include normal maintenance and repair or the replacement of equipment that has previously been approved unless the result of the maintenance or repair is that the type, size or operating characteristics of the equipment are substantially different from those of the original.

(Added to NAC by Bd. of Health, eff. 11-1-88)

NAC 444.064 “Slide runout” defined. ([NRS 439.200](#), [444.070](#)) “Slide runout” means a shallow flume at the end of a water slide in which the bather ends his or her slide.

(Added to NAC by Bd. of Health, eff. 11-1-88)

NAC 444.066 “Slip resistant” defined. ([NRS 439.200](#), [444.070](#)) “Slip resistant” means a finish or textured surface designed to prevent or reduce slipping by bare skin in contact with it under wet conditions.

(Added to NAC by Bd. of Health, eff. 11-1-88)

NAC 444.068 “Special purpose pool” defined. ([NRS 439.200](#), [444.070](#)) “Special purpose pool” means a swimming pool that is used exclusively for supervised instruction, training, therapy, treatment or competition.

(Added to NAC by Bd. of Health, eff. 11-1-88)

NAC 444.070 “Spray pool” defined. ([NRS 439.200](#), [444.070](#)) “Spray pool” means a recreation area intended for use by children, in which water is supplied by a system of sprays but is not allowed to accumulate.

[Bd. of Health, Public Bathing Places Reg. Art. 1 § 1.5, eff. 5-21-74]

NAC 444.075 “Swimming pool” defined. ([NRS 439.200](#), [444.070](#))

1. “Swimming pool” means any structure containing an artificial body of water that is intended to be used collectively by persons for swimming or bathing, regardless of whether a fee is charged for its use.

2. The term does not include:

- (a) Any structure at a private residence controlled by the owner of the residence, the use of which is limited to members of the family or invited guests of the owner; or
- (b) Any other kind of public bathing or swimming facility.
(Added to NAC by Bd. of Health, eff. 11-1-88)

NAC 444.085 “Turnover cycle” defined. ([NRS 439.200](#), [444.070](#)) “Turnover cycle” means the period of time required to completely recirculate the water in a public bathing or swimming facility through its filter and treatment systems.
(Added to NAC by Bd. of Health, eff. 11-1-88)

NAC 444.090 “Wading pool” defined. ([NRS 439.200](#), [444.070](#)) “Wading pool” means a small pool to be used mainly by nonswimming children, and those supervising the children.
[Bd. of Health, Public Bathing Places Reg. Art. 1 § 1.8, eff. 5-21-74]

NAC 444.092 “Water recreation attraction” defined. ([NRS 439.200](#), [444.070](#))

1. “Water recreation attraction” means any:
 - (a) Activity pool;
 - (b) Child amusement lagoon;
 - (c) Water slide;
 - (d) Watercourse ride; or
 - (e) Wave pool.
2. The term does not include any facility at a private residence controlled by the owner of the residence, the use of which is limited to members of the family or invited guests of the owner.
(Added to NAC by Bd. of Health, eff. 11-1-88)

NAC 444.093 “Water slide” defined. ([NRS 439.200](#), [444.070](#)) “Water slide” means a water recreation attraction having one or more flumes.
(Added to NAC by Bd. of Health, eff. 11-1-88)

NAC 444.094 “Watercourse ride” defined. ([NRS 439.200](#), [444.070](#)) “Watercourse ride” means a water recreation attraction designed to convey bathers on inner tubes or raft-like devices, using an artificially created current, along a relatively flat watercourse.
(Added to NAC by Bd. of Health, eff. 11-1-88)

NAC 444.096 “Wave pool” defined. ([NRS 439.200](#), [444.070](#)) “Wave pool” means a water recreation attraction characterized by the artificial generation of waves at one end of a pool.
(Added to NAC by Bd. of Health, eff. 11-1-88)

NAC 444.097 Severability. ([NRS 439.200](#), [444.070](#)) If any provision of [NAC 444.010](#) to [444.306](#), inclusive, is declared unconstitutional or invalid for any reason, the remainder of the provisions of those sections are not intended to be affected thereby.
[Bd. of Health, Public Bathing Places Reg. Art. 48, eff. 5-21-74]—(NAC A 11-1-88)

Preliminary Requirements

NAC 444.100 Application; plans and specifications. ([NRS 439.200](#), [444.070](#), [444.080](#))

1. Any person desiring to construct a public bathing or swimming facility or to remodel or add to an existing facility must apply in writing to the health authority on forms furnished by the health authority, giving the name of the facility and its location together with such other information as may be required. The application must be accompanied by plans and specifications with supporting data prepared by a professional engineer who is registered in this State, an architect who is registered in this State, or a licensed contractor who holds a classification A license with an A-10 subclassification issued by the State Contractors’ Board. A

licensed professional engineer or a registered architect shall include his or her seal and signature on any plans and specifications submitted to the health authority. A licensed contractor shall include his or her signature on any plans and specifications submitted to the health authority.

2. The plans must be drawn to scale, contain a north arrow and must be accompanied by proper specifications so as to permit a comprehensive engineering review of the plans. The plans must include:

(a) Plan and sectional views with all necessary dimensions of the facility.

(b) A piping diagram showing all appurtenances including treatment facilities in sufficient detail, as well as pertinent elevation data, to permit a hydraulic analysis of the system.

(c) Details on all treatment equipment, including catalog identification. If mechanical equipment is specified by the use of a trade name or catalog numbers, individual leaflets, catalogs or other descriptive material must be furnished. This material will be returned to the applicant on his or her request after the review of the plans.

(d) An electrical diagram showing the method of grounding, junction boxes and other pertinent details.

(e) Detailed plans of bathhouses, equipment rooms, dressing rooms, toilet facilities, showers and other appurtenances.

3. The plans and specifications must be submitted in triplicate. Additional copies must be submitted if requested.

4. The submitted plans must be approved in writing before any construction is undertaken.

[Bd. of Health, Public Bathing Places Reg. Art. 2 §§ 2.1-2.1.5.5, eff. 5-21-74]—(NAC A 11-1-88; 1-16-96)

NAC 444.102 Changes in plans; structural adequacy. ([NRS 439.200](#), [444.070](#), [444.080](#))

1. The facility must be built in accordance with the plans as approved, unless prior approval of the changes has been given in writing by the health authority.

2. The review of the plans by the health authority will not include a review of the structural design or structural stability of any section or part of the facility. Certification of structural adequacy is the responsibility of the architect or a qualified professional engineer who is licensed by the State Board of Registered Professional Engineers and Land Surveyors.

[Bd. of Health, Public Bathing Places Reg. Art. 2 §§ 2.2 & 2.2.3, eff. 5-21-74]—(NAC A 11-1-88)

NAC 444.104 Inspections. ([NRS 439.200](#), [444.070](#), [444.090](#))

1. The owner or his or her agent shall notify the health authority at specific predetermined stages of construction and at the time of completion of the facility, to permit inspection of the facility during and after construction.

2. In areas where the health authority cannot provide the inspections and where the local government does not require building inspections, the owner or his or her agent may be required to hire a third party inspector. The third party inspector may be selected by the owner or his or her agent upon the approval of the Health Division.

3. The facility may not be placed in operation until the inspection shows compliance with the requirements of [NAC 444.010](#) to [444.306](#), inclusive.

[Bd. of Health, Public Bathing Places Reg. Art. 2 §§ 2.2.1 & 2.2.2, eff. 5-21-74]—(NAC A 11-1-88)

General Standards for Construction

NAC 444.108 Use of equipment and materials not designated by NSF International. ([NRS 439.200](#), [444.070](#)) The health authority may permit the use of equipment and materials which are not designated by the NSF International as complying with the standards adopted pursuant to [NAC 444.010](#) to [444.306](#), inclusive, if the health authority determines that the equipment and materials comply with standards equivalent to the NSF International Standards.

(Added to NAC by Bd. of Health, eff. 1-16-96)

NAC 444.110 Location. ([NRS 439.200](#), [444.070](#)) A pool must be located where it will not be exposed to undesirable substances or surface drainage from surrounding areas.

[Bd. of Health, Public Bathing Places Reg. Art. 6, eff. 5-21-74]—(NAC A 11-1-88)

NAC 444.112 Shape. ([NRS 439.200](#), [444.070](#))

1. The shape of any pool must be such that the circulation of pool water and supervision of swimmers are not impaired.

2. There must be no obstruction extending from the wall or the floor, extending into the clear area of the diving portion.

3. The use of solid barriers or fences between the various depths is prohibited.

[Bd. of Health, Public Bathing Places Reg. Art. 8, eff. 5-21-74]

NAC 444.114 Side walls and bottoms. ([NRS 439.200](#), [444.070](#))

1. The side walls and bottoms of all pools must be constructed of materials which are inert, nontoxic to humans, impervious, permanent and enduring and which can withstand the anticipated loading for empty and full conditions.

2. Pools must be constructed of concrete or other impervious and structurally rigid materials with a finish adapted to the bathing demands of different areas of the pools. All side walls and bottom surfaces must be watertight, free from structural cracks, and have a slip-resistant finish which is smooth and easily cleanable. Floors and walls below the gutter and 6-inch tile line must be white or light pastel in color and must reflect any natural or artificial light.

3. Any design incorporated into the construction of a pool or painted on the floor or walls must not prevent the detection of algae, sediment, a human in distress or other objects in the pool. Permission in writing from the health authority for the use of a design must be obtained before the design is used.

4. All corners formed by the intersection of walls and floors must be covered. Painting of new pools is not recommended.

5. Provision must be made for the relief of pressures which might occur as a result of unbalanced exterior hydrostatic pressures, or means must be provided for positive and continuous drainage from under the pool floor and around the pool walls wherever groundwater is present.

6. Provision must be made to protect the pool structure from both internal and external stresses which may develop due to freezing.

[Bd. of Health, Public Bathing Places Reg. Art. 7, eff. 5-21-74]—(NAC A 11-1-88)

NAC 444.116 Limitations on depth; signs prohibiting diving. ([NRS 439.200](#), [444.070](#))

1. Every swimming pool must have a minimum depth in the shallow area of the main swimming pool area of not less than 3 feet (0.9 meter) or more than 3 feet 6 inches (1.1 meters) from the normal operating level to the floor. Exceptions may be made for special purpose pools, or in a recessed area of the main swimming pool where the pool is of an irregular shape such as the leg of a T, L or Z, separated from the main pool by a lifeline.

2. If steps extend for more than one-half the width of the shallow portion of the pool, the depth of water at the base of the lowest step must not be greater than 3 feet 6 inches (1.1 meters).

3. The side walls of the pool must be vertical at all points for a depth of not less than 2 feet 6 inches (0.8 meter).

4. If a pool is not designed for diving, a sign stating "NO DIVING," in contrasting characters of not less than 4 inches (10.16 centimeters) in height, must be posted.

[Bd. of Health, Public Bathing Places Reg. Art. 9, eff. 5-21-74]—(NAC A 11-1-88)

NAC 444.118 Marking depth. ([NRS 439.200](#), [444.070](#))

1. The depth of the water in a pool must be plainly marked in units of feet at or above the water surface on the vertical pool wall at maximum and minimum points and at the points of break between the deep and shallow portions and at intermediate increments of depth, spaced at not more than 25-foot (7.6-meter) intervals.

2. Depth markers must be in numerals not less than 4 inches (10 centimeters) in height and of a color contrasting with the background. Markers must be on both sides and at the ends of the pool.

3. The markings must be plainly visible to persons in the pool and to persons about to enter the water.

[Bd. of Health, Public Bathing Places Reg. Art. 12, eff. 5-21-74]—(NAC A 11-1-88)

NAC 444.120 Slope. ([NRS 439.200](#), [444.070](#))

1. Except as otherwise provided in [NAC 444.1958](#), the floor slope in a pool must not be steeper than:
 - (a) One in 12 in the shallow end; or
 - (b) One in 3 in the deep end.
2. The slope must be uniform, and the bottom surface must be smooth but must have a slip-resistant finish.
3. All portions of the pool bottom must have a definite slope toward the pool drains.
4. Except as otherwise provided in [NAC 444.1958](#), the depth at the slope break must be 5 feet (1.5 meters). An exception may be made permitting the breakpoint to occur at a minimum of 4 feet 6 inches (1.4 meters) for pools less than 60 feet (18.3 meters).

[Bd. of Health, Public Bathing Places Reg. Art. 10, eff. 5-21-74]—(NAC A 11-1-88)

NAC 444.122 Diving area and equipment. ([NRS 439.200](#), [444.070](#))

1. In a pool in which diving and swimming are allowed, the area of the pool in which diving is permitted must be:
 - (a) In the case of a rectangular pool, at one end of the pool which is separated from the main swimming area by a lifeline.
 - (b) In the case of a T, L or Z shaped pool, in a recessed area forming one of the legs of the T, L or Z which is separated from the main swimming area by a lifeline.
- È A pool designed only for diving may be located in an area which is separate from a pool designed for swimming.

2. A pool for which an operating permit is issued before January 16, 1996, and in which diving is allowed must contain an adequate area and a depth of water to provide safe diving. A pool for which an operating permit is issued on or after January 16, 1996, and in which diving is allowed must contain an area and depth of water that complies with Article IV of the *American National Standard for Swimming Pools: ANSI/NSPI-1 1991*, which is hereby adopted by reference. A copy of the article may be obtained from the National Spa and Pool Institute, 2111 Eisenhower Avenue, Alexandria, Virginia 22314, at a cost of \$32.

3. Diving boards, towers and platforms in excess of 3 meters in height are not allowed in a pool without special provisions, controls and definite limitations on their use. Where such boards, towers or platforms are permitted, their use must be limited to adequately trained personnel and must not be open to the general public.

4. Diving boards, towers and platforms must have a slip-resistant finish and, if covered with an absorbent material, the cover must be disinfected daily.

5. At least 16 feet (4.9 meters) of unobstructed clearance must be provided above diving boards and platforms.

6. Supports, platforms and steps for diving boards must be of substantial construction and of sufficient structural strength to carry the maximum anticipated loads safely. Steps must be of corrosion resistant material, easily cleanable and of slip-resistant design.

7. Handrails must be provided at all steps and ladders leading to diving boards more than 1 meter above the water, except those ladders set at 15° or less from the vertical. Platforms and diving boards which are over 1 meter high must be protected with guard railings.

[Bd. of Health, Public Bathing Places Reg. Art. 13, eff. 5-21-74]—(NAC A 11-1-88; 9-16-92; 1-16-96)

NAC 444.126 Lifelines. ([NRS 439.200](#), [444.070](#))

1. Devices for fastening lifelines must be installed at least 2 feet (0.6 meter) toward the shallow end from the break in grade between the shallow portion and the deep portion of a pool. These devices must be securely anchored, of corrosion resistant material and of a type which will be recessed or have no hazardous projection.

2. A lifeline with floats must be installed if required by the health authority.

[Bd. of Health, Public Bathing Places Reg. Art. 11, eff. 5-21-74]—(NAC A 11-1-88)

NAC 444.128 Ladders and stairs. ([NRS 439.200](#), [444.070](#))

1. Stairs or ladders must be provided at the shallow portion of a pool if the vertical distance from the bottom of the pool to the deck or walk is over 2 feet (0.6 meter). Stairs or ladders must be provided at the deep portion of the pool. If the pool is over 30 feet (9.1 meters) wide, such stairs or ladders must be provided at each side of the deep portion of the pool.

2. A minimum of one ladder must be provided for each 75 feet (22.3 meters) of perimeter and not less than two ladders must be provided at any pool. Where stairs are provided in a pool, one ladder may be deleted for each set of stairs provided.

3. Pool ladders must be corrosion resistant and must be equipped with slip-resistant treads.

4. If stepholes are provided, they must be of such design that they may be readily cleaned and must drain into the pool to prevent accumulation of dirt. Stepholes must have a minimum tread of 5 inches (13 centimeters) and a minimum width of 14 inches (36 centimeters).

5. A side handrail extending up above and returning to the horizontal surface of the pool deck, curb, or coping must be provided at each side of each ladder or set of stepholes. There must be a clearance of not more than 5 inches (13 centimeters) or less than 3 inches (9 centimeters) between the ladder and the pool wall.

6. Stairs leading into the pool must be of slip-resistant design, have a minimum tread of 12 inches (30 centimeters), and a maximum rise of 10 inches (25 centimeters). The edge of the stair tread must be constructed of a material so colored as to contrast with the color of the stairs and be clearly visible and evident to bathers.

7. All stairs entering a pool must be recessed into the walls of the pool and a guardrail must be provided in the walkway around the stairwell. An exception to this will permit the construction of steps at the shallow end of the pool. An approved handrail must be provided for each set of stairs.

[Bd. of Health, Public Bathing Places Reg. Art. 14, eff. 5-21-74]—(NAC A 11-1-88)

NAC 444.130 Handholds. ([NRS 439.200](#), [444.070](#))

1. Every pool must be provided with a handhold around the entire perimeter of the pool, such as a perimeter overflow system, bull-nosed coping or cantilevered decking, installed not more than 9 inches (22.86 centimeters) above the waterline.

2. For special purpose pools used for instruction or competitive swimming, a handhold at water level similar to the rim of a perimeter overflow system is required.

3. If a perimeter overflow system is not provided, bull-nosed coping, cantilevered decking of reinforced concrete or material equivalent in strength and durability must be provided. The coping, decking or other material must have rounded, slip-resistant edges, and must not exceed 3 1/2 inches (8.89 centimeters) in thickness. The overhang of the coping, decking or other material must not exceed 2 inches (5.08 centimeters) nor be less than 1 inch (2.54 centimeters).

[Bd. of Health, Public Bathing Places Reg. Art. 18, eff. 5-21-74]—(NAC A 11-1-88)

NAC 444.132 Chairs for lifeguards. ([NRS 439.200](#), [444.070](#))

1. Each pool must have at least one elevated lifeguard chair. This shall be presumed to be adequate for 2,000 square feet (185.8 square meters) of pool surface area with an additional lifeguard chair being provided for each additional area of 2,000 square feet (185.8 square meters) or major fraction thereof.

2. If a pool is provided with more than one lifeguard chair and the pool width is 40 feet (12.2 meters) or more, chairs must be located on each side of the pool.

3. The chairs must be located to provide a clear, unobstructed view of the bottom of the pool in the area of surveillance.

4. The requirements of this section may be waived by the health authority in the case of a swimming pool serving a motel, apartment or hotel and having a surface area of less than 2,000 square feet (185.8 square meters).

5. Lifeguard stations may be substituted for lifeguard chairs with written approval of the health authority.

[Bd. of Health, Public Bathing Places Reg. Art. 36, eff. 5-21-74]—(NAC A 11-1-88)

NAC 444.133 Innovative designs; bridges and walkways. ([NRS 439.200](#), [444.070](#))

1. An innovative swimming pool design or a bridge or walkway over a pool must not endanger the health or safety of bathers or contribute contamination of any kind to the water in the pool.
 2. Any such bridge or walkway must:
 - (a) Be not less than 8 feet (2.4 meters) above the bottom of the pool and not less than 4 feet (1.2 meters) above the surface of the water in the pool;
 - (b) Have a slip-resistant surface which can be cleaned by hosing and will cause no discomfort to bare feet; and
 - (c) Be perpendicular to the edge of the pool at any point where it meets the edge or, if the edge is curved at the point of intersection, to a tangent passing through that point.
- (Added to NAC by Bd. of Health, eff. 11-1-88)

NAC 444.134 Decks. ([NRS 439.200](#), [444.070](#))

1. Except as otherwise provided in this subsection and in [NAC 444.196](#) and [444.1995](#), a clear, unobstructed deck must be provided around the entire perimeter of a pool. In no case may the width of the deck be less than 4 feet (1.2 meters). A deck may be obstructed for a distance equal to not more than 10 percent of the perimeter of the pool if:
 - (a) The design of the obstruction does not endanger the health or safety of persons using the pool;
 - (b) An unobstructed area of deck not less than 4 feet wide is provided around or through the obstruction not more than 15 feet (4.55 meters) from the edge of the pool; and
 - (c) Written approval for the obstruction is obtained from the health authority before construction or installation of the obstruction.
2. The paved area of the deck must extend not less than 4 feet (1.2 meters) from both sides and rear of any diving board or its appurtenances.
3. The surface of the paved deck must not drain into the pool or the overflow gutter. Drainage must be conducted from the deck in a manner that will not create muddy, hazardous or objectionable conditions. Decks must slope on a minimum slope of 1/4 inch per foot (2 percent) to the drains to points at which the water will have a free, unobstructed flow to points of disposal at all times. If deck drains are provided, they must be spaced or arranged so that not more than 400 square feet (37.2 square meters) of area is tributary to each drain and drains must not be more than 25 feet (7.6 meters) apart. Drainage from the decks must not be returned to the recirculation system.
4. The deck must have a slip-resistant surface that can be cleaned by hosing and causes no discomfort to bare feet.
5. Provision must be made to prevent the drainage of materials from lawns or landscaped areas onto the pool decks or into the pool.

[Bd. of Health, Public Bathing Places Reg. Art. 15, eff. 5-21-74]—(NAC A 11-1-88)

NAC 444.135 Use of manufactured products to resist slipping. ([NRS 439.200](#), [444.070](#)) A manufactured product may not be used at a public bathing or swimming facility or natural bathing place to provide a slip-resistant finish or surface unless it is intended by the manufacturer to provide resistance to slipping under wet conditions.

(Added to NAC by Bd. of Health, eff. 11-1-88)

NAC 444.136 Barriers; exclusion of unauthorized persons. ([NRS 439.200](#), [444.070](#))

1. Provision must be made to exclude unauthorized persons from any pool or pool area. A pool must be surrounded by a fence, wall, building or other barrier that completely encloses the pool area and otherwise complies with the requirements of this section. No part of a pool enclosure may be used for common foot traffic.
2. The barrier must be impenetrable for small children and must not offer any external handholds or footholds.
3. In the case of a swimming pool operated solely for and in conjunction with a hotel, motel or other place of lodging, or a trailer park, apartment, condominium or other facility containing multiple dwellings, the barrier must be not less than 5 feet (1.5 meters) in height. Courtyard-type concepts in which gates or

doors open directly into a pool enclosure from a dwelling unit or hotel or motel room are not permitted. In any other case, the barrier must be not less than 6 feet (1.8 meters) in height.

4. Any vertical members in the barrier must not be more than 4 inches (10.16 centimeters) apart.
5. Any opening at the bottom of the barrier must not be more than 4 inches (10.16 centimeters) in height.
6. Any gate or door that opens into the pool area:

(a) Must be equipped with permanent locking devices and self-closing and positive self-latching mechanisms. Self-closing and self-latching mechanisms must be located not less than 3 1/2 feet above the ground.

(b) Must self-close and positively self-latch from any open position.

(c) Must not be blocked open or otherwise disabled to prevent closing and latching.

(d) Must, in the case of an indoor pool, be made of metal and installed in a metal frame.

Ê The operator of the pool shall periodically inspect each such gate or door to ensure that it is operating properly.

7. Facilities, such as large resort hotels, which have continuous, 24-hour-a-day security of the pool area may be exempt from the requirements of this section.

8. Where existing construction prohibits compliance with the requirements of this section, the owner shall file with the health authority an operation procedure which will serve to ensure the exclusion of unattended small children from the pool.

[Bd. of Health, Public Bathing Places Reg. Art. 16, eff. 5-21-74]—(NAC A 11-1-88)

NAC 444.138 Hose bibs. ([NRS 439.200](#), [444.070](#)) Hose bibs must be provided in locations where necessary to enable thorough hosing down of all walks, floors and appurtenances. They must be located so they do not constitute a safety hazard.

[Bd. of Health, Public Bathing Places Reg. Art. 17, eff. 5-21-74]

NAC 444.140 Electrical requirements. ([NRS 439.200](#), [444.070](#))

1. All new electrical wiring in a public bathing or swimming facility must conform with the 1987 edition of the *National Electric Code* of the National Fire Protection Association and applicable state and local building codes. A copy of the *Code* may be obtained from the International Conference of Building Officials, 5360 South Workman Mill Road, Whittier, California 90601, at a cost of \$20.50. All equipment, fixtures and wiring must bear an appropriate label issued by Underwriters Laboratories Inc., or an equivalent organization.

2. All electrical devices such as portable announcing systems, radios and soft drink dispensers that might be around the pool deck and immediate environment must not be within the reach of bathers.

3. Ground fault circuit interrupters must be provided on all new facilities in accordance with the 1987 edition of the *National Electric Code* for all lighting circuits as well as for motors and other electrical circuits in the area of any pool. These devices are required on an existing facility if the health authority determines it is necessary to protect the safety of bathers.

[Bd. of Health, Public Bathing Places Reg. Art. 32, eff. 5-21-74]—(NAC A 11-1-88)

NAC 444.142 Lighting. ([NRS 439.200](#), [444.070](#))

1. Artificial lighting must be provided for all public bathing or swimming facilities, natural bathing places, bathhouses, toilet rooms, dressing rooms, and equipment rooms that are to be used at night or that do not have adequate natural lighting.

2. Pools designed and maintained for use at night must be equipped with lighting designed and spaced so that all parts of the pool, including the bottom, may be readily seen without glare.

3. The lighting system for outdoor pools must be designed with sources of illumination located so as to prevent insects attracted by the lights from falling into the water.

4. Where underwater lighting is used, not less than 0.5 watts (10 lamp lumens) must be employed per square foot (.093 square meter) of water surface area.

5. If bathing or swimming at night is permitted and underwater lighting:

(a) Is used, area lighting must be directed toward deck areas to the extent practical and not less than 0.6 watts must be employed per square foot (.093 square meter) of deck area.

(b) Is not used, area and pool lighting must be provided and not less than 2.0 watts must be employed per square foot (.093 square meter) of deck area.

6. The lenses of pool lights must be clear so that the inside of the light is visible during inspection.

7. If lighting is not provided as required by this section, the operator of the facility or natural bathing place:

(a) Shall not permit any use of the facility or bathing place after dark.

(b) Shall post a sign stating "NO SWIMMING, BATHING OR OTHER USE OF FACILITY ALLOWED AFTER DARK," in contrasting characters not less than 4 inches (10.16 centimeters) in height, near each entrance to the facility or bathing place.

[Bd. of Health, Public Bathing Places Reg. Art. 31, eff. 5-21-74]—(NAC A 11-1-88)

NAC 444.144 Acoustics. ([NRS 439.200](#), [444.070](#)) All indoor pool enclosures must receive acoustical treatment which will prevent reverberations of sound that may result in lack of control on the part of the lifeguards or instructors.

[Bd. of Health, Public Bathing Places Reg. Art. 34, eff. 5-21-74]—(NAC A 11-1-88)

NAC 444.146 Connections for supply and disposal of water. ([NRS 439.200](#), [444.070](#))

1. No direct mechanical connection with a domestic water supply may be made to a public bathing or swimming facility, a chlorinator or the system of piping for the facility, unless it is protected against backflow in a manner approved by the health authority. All pools must be equipped with acceptable provisions, such as overfall fillspouts, surge tanks or receptors, for adding makeup water.

2. Water used to fill any pool must be supplied by an overfall fillspout providing an airgap of not less than 6 inches (15 centimeters) between the flood level at the pool and the lowest point of the fillspout, or an overfall supply to a surge tank or receptor wherein the water will freely overflow at deck level or the top of the surge tank or receptor before coming in contact with the water supply outlet.

3. Sanitary sewage from the bathhouse must be discharged into a sewage system approved by the health authority.

[Bd. of Health, Public Bathing Places Reg. Art. 24, eff. 5-21-74]—(NAC A 7-23-82; 11-1-88)

NAC 444.148 Quality of water. ([NRS 439.200](#), [444.070](#))

1. Water entering a public bathing or swimming facility for the first time must meet the bacteriological standards for potable water set forth in the primary drinking water standards adopted pursuant to [NRS 445A.855](#), except the health authority may approve the use of water from natural sources including saline water. Fresh water must be added to pools that depend upon the flow of a stream, lake, well or other source which has been diverted to flow in and out of the pool, at a rate of not less than 1,000 gallons (378.5 liters) per hour for each 20 bathers using the pool during each hour.

2. All public bathing or swimming facilities must have a uniform flow-through of water in the volume and quality described in subsection 1, or recirculation and filtration equipment provided for water purification in accordance with the requirements of [NAC 444.010](#) to [444.306](#), inclusive.

3. The equipment must provide water which meets the following standards:

(a) The water must be continuously disinfected by a chemical which imparts an easily measured, freely available residual effect. Except as otherwise provided in [NAC 444.207](#), adequate disinfection must be accomplished by one of the following:

(1) Normal chlorination of 1.0 to 5.0 ppm chlorine at pH 7.0 to 8.0;

(2) Chlorinated cyanurate chlorination of 1.0 to 5.0 ppm at pH 7.2 to 8.0; or

(3) Normal bromination of 3.0 to 5.0 ppm at pH 7.0 to 8.0.

(b) The health authority may accept other disinfecting materials or methods if they have been adequately demonstrated to provide a satisfactory residual effect which is easily measured, and otherwise to be equally as effective under conditions of use as the chlorine concentration required in this section.

(c) The maximum permissible concentration of cyanuric acid is 100 ppm.

(d) The total alkalinity should be within the range of 80 to 120 ppm.

4. The chemical quality of water used in the facility must not cause irritation to the eyes or skin of the bathers, or have other objectionable physiological effects on bathers.

5. The water must have sufficient clarity at all times so that the pattern of the main drain in any pool is clearly visible from the walk at the deep end. Failure to meet this requirement constitutes a ground for the immediate closing of the facility.

[Bd. of Health, Public Bathing Places Reg. Art. 20 §§ 20.1-20.5, eff. 5-21-74]—(NAC A 7-23-82; 11-1-88)

NAC 444.150 Sampling of water. (NRS 439.200, 444.070)

1. Samples of water from each public bathing or swimming facility must be submitted to the laboratory of the Health Division once a week for bacteriological testing. This requirement may be waived for facilities maintaining approved operating records and having dependable disinfection and filtration.

2. Not more than 15 percent of the samples must either:

(a) Contain more than 200 bacteria per milliliter, as determined by the standard (35°C) agar plate count;

or

(b) Show positive test (confirmed test) for coliform organisms in any of the five 10 milliliter portions of a sample or more than 1.0 coliform organisms per 50 milliliter if the membrane filter test is used.

3. All samples must be collected, dechlorinated and examined in accordance with the procedures outlined in the latest edition of *Standard Methods for the Examination of Water and Wastewater* (APHA).

[Bd. of Health, Public Bathing Places Reg. Art. 20 §§ 20.6 & 20.6.1, eff. 5-21-74]—(NAC A 11-1-88)

NAC 444.152 System for recirculation. (NRS 439.200, 444.070)

1. Except as otherwise provided in [NAC 444.198](#) to [444.1995](#), inclusive, and [444.202](#), a recirculation system, consisting of pumps, filters, water conditioning, disinfection equipment and other accessory equipment, must be provided at each public bathing or swimming facility which will recirculate, clarify and disinfect the volume of water used in the facility every 6 hours or less.

2. The patterns of recirculation developed in any pool must be partial flow through the main drain and the remainder through the overflow gutters or skimmers.

3. The recirculation system must include a vacuum gauge located on or immediately before the pump on the suction side of the system and a pressure gauge immediately after the pump on the pressure side of the system.

4. The recirculation system must be operated at all times the facility is open for use and for not less than 3 hours after the facility is closed. If the system is shut down for periodic maintenance and repair, no person who is not an employee of the facility may be allowed into the facility.

5. If time clocks are used to govern the operation of the recirculation system, they must be:

(a) Used to govern the operation of any equipment, such as chemical disinfectant feeders, slurry feeders or heaters, dependent upon the flow of water within the system.

(b) Reset immediately after any interruption in power.

[Bd. of Health, Public Bathing Places Reg. Art. 26 §§ 26.1 & 26.2, eff. 5-21-74]—(NAC A 11-1-88)

NAC 444.154 Rate of flow. (NRS 439.200, 444.070) An adequate number of rate of flow indicators and rate of flow controllers having satisfactory range must be installed and properly located, so that the rate of flow either during normal circulation or during the filter backwashing operation can be determined.

[Bd. of Health, Public Bathing Places Reg. Art. 26 § 26.6, eff. 5-21-74]

NAC 444.156 Inlets. (NRS 439.200, 444.070)

1. Except as otherwise provided in this subsection, inlets must be rounded and smooth and installed not less than 18 inches (46 centimeters) below the normal operating level and located to produce a uniform circulation, without the existence of dead spots. In the case of a shallow pool, an exception to this requirement may be granted by the health authority if inlets cannot be installed at the depth otherwise required.

2. Inlets must not extend from the pool wall or floor so as to create a hazard.

3. Each set of stairs must have an inlet to provide good circulation over the stairs.

4. Except as otherwise provided in subsection 6, if wall inlets are used, the distance between adjacent

inlets must not exceed 15 feet (4.6 meters).

5. Except as otherwise provided in this subsection, any pool having a width greater than 40 feet (12.19 meters) must have floor inlets meeting the requirements of this subsection or a combination of wall and floor units meeting the requirements of subsection 4 and this section. If floor inlets are used:

- (a) They must be located so that they provide general circulation and not direct flow to floor drains; and
- (b) The distance between:
 - (1) Adjacent floor inlets must not exceed 15 feet.
 - (2) Floor units and the nearest wall must not exceed 10 feet.

6. Except as otherwise provided in subsection 5 and notwithstanding the provisions of subsection 4, any combination of wall and floor units may be used if it is shown to produce a uniform circulation.

[Bd. of Health, Public Bathing Places Reg. Art. 26 §§ 26.11-26.11.3, eff. 5-21-74]—(NAC A 7-23-82; 11-1-88)

NAC 444.158 Drains. ([NRS 439.200](#), [444.070](#))

1. All pools must be provided with a main drain at the lowest point of the floor of the pool to permit the pool to be completely and easily drained.

2. The distance of each main drain from:

- (a) The nearest main drain must not exceed 20 feet (6.1 meters) on the centers.
- (b) Any side wall must not exceed 15 feet (4.6 meters).

3. The sump of each main drain must be covered with a suitable protective cover or grate securely fastened in such a way that it cannot be removed without the use of tools. The openings in the grate must not exceed 1/2 inch (1.27 centimeters) in diameter. Except as otherwise provided in this subsection, the velocity of water through the grate must not exceed 1.5 feet per second. If only one main drain in the pool is connected to a pump:

- (a) The drain must be of antivortex design.
- (b) The velocity of water through the grate must not exceed 6 feet per second.

4. The recirculation system must be designed to guard against outlet entrapment. Any of the following means may be employed:

(a) The system must include no fewer than two main drains, separated by not less than 4 feet (1.22 meters), and connected to pipes of equal diameter. The system must not permit any cutoff of either drain from the suction line.

(b) The system must include one or more antivortex outlet drains. Any drain installed at a depth of 4 1/2 feet (1.37 meters) or less must not present a tripping hazard to the bather.

(c) Any other system, approved by the health authority, that guards against outlet entrapment.

5. Valves or pumps used for draining pools must be sized to prevent the surcharging of the receiving drain. Multiport valves must:

(a) Comply with all applicable requirements of Standard 50 of the National Sanitation Foundation. A copy of this standard may be obtained from the National Sanitation Foundation, P.O. Box 1468, Ann Arbor, Michigan 48106, at a cost of \$8.

(b) In the absence of an applicable standard, be approved by the health authority.

6. The main drains must be capable of taking at least 50 percent of the circulated flow.

7. As used in this section:

(a) "Antivortex drain" means a drain having a raised cover designed to prevent or minimize any suctioning effect on a person that comes into contact with the drain.

(b) "Multiport valve" means a separate switching valve that has a separate position for each of the various filter operations and that combines in one unit the functions of two or more direct-flow valves.

[Bd. of Health, Public Bathing Places Reg. Art. 26 §§ 26.7-26.7.4, eff. 5-21-74]—(NAC A 9-17-82; 11-1-88)

NAC 444.160 Piping. ([NRS 439.200](#), [444.070](#))

1. The water velocity in the piping of a public bathing or swimming facility must not exceed 10 feet (3 meters) per second for discharge piping, except that the velocity for copper pipe must not exceed 6 feet (1.8 meters) per second. Suction velocity for piping must not exceed 6 feet (1.8 meters) per second for both. If

velocities exceed these rates, summary calculations must be provided to show that rated flows are possible with the pump and piping provided.

2. Piping must be of a nontoxic material, resistant to corrosion and able to withstand operating pressures. All plastic piping and fittings used in the recirculation system must be imprinted with the name of the manufacturer and the potable water mark of the National Sanitation Foundation, or its equivalent, and must:

(a) Comply with all applicable requirements of Standard 14 for potable water applications of the National Sanitation Foundation. A copy of this standard may be obtained from the National Sanitation Foundation, P.O. Box 1468, Ann Arbor, Michigan 48106, at a cost of \$9.

(b) In the absence of an applicable standard, be approved by the health authority.

3. Pipes must be identified by color code or tags.

4. All piping must be supported on piers or other substantial means to prevent possible settlement which will either provide dirt traps or air pockets.

5. All pressure and suction lines must have a uniform slope in one direction of not less than 3 inches per 100 feet (0.25 percent). Gravity waste lines around any pool 6 inches (15 centimeters) or smaller must have a minimum slope of one-quarter of an inch per foot (2 percent). Lines larger than 6 inches (15 centimeters) and all outfall main lines must be designed with a size of pipe and slope to carry freely the maximum flows.

[Bd. of Health, Public Bathing Places Reg. Art. 26 §§ 26.3-26.3.4, eff. 5-21-74]—(NAC A 7-23-82; 11-1-88)

NAC 444.162 Pumps and motors. ([NRS 439.200](#), [444.070](#))

1. A pump and motor unit must be provided for the recirculation of water which has been selected for performance and will meet the conditions of quantity required for filtering and cleaning the filters with the total dynamic head developed by the complete system.

2. The requirements for filtration must be based upon the maximum head loss developed immediately before washing the filters.

3. The motor must be nonoverloading in continuous operation for filtration under all conditions, but may be overloaded within the service factor for conditions of backwash and for emptying any pool.

4. A pump performance curve for the unit to be installed must be provided with the plans submitted for approval.

5. A pump used in a recirculation system must:

(a) Comply with all applicable requirements of Standard 50 of the National Sanitation Foundation. A copy of this standard may be obtained from the National Sanitation Foundation, P.O. Box 1468, Ann Arbor, Michigan 48106, at a cost of \$8.

(b) In the absence of an applicable standard, be approved by the health authority.

[Bd. of Health, Public Bathing Places Reg. Art. 26 § 26.4, eff. 5-21-74]—(NAC A 11-1-88)

NAC 444.164 Arrangements for overflow. ([NRS 439.200](#), [444.070](#)) Every pool must be provided with overflow gutters or skimmers. Other kinds of overflow arrangements and pool edges, including deck level pools, may be installed if approved by the health authority. No such pool may be installed or built if a safety hazard may result.

[Bd. of Health, Public Bathing Places Reg. Art. 26 § 26.8, eff. 5-21-74]—(NAC A 11-1-88)

NAC 444.166 Gutters. ([NRS 439.200](#), [444.070](#))

1. Except as otherwise provided in [NAC 444.1968](#), the overflow gutter around any pool must be continuous around the pool except at stairs or recessed ladders.

2. The overflow gutter may also serve as a handhold. The overflow edge must be rounded and must not be thicker than 2 1/2 inches (6 centimeters) for the top 2 inches (5 centimeters).

3. The gutter lip must be smooth and uniform and at a precise level in a horizontal plane so far as is practical within the limits of craftsmanship.

4. The pool water level must be maintained about an inch below the gutter during periods of pool use. During daily cleanup operations the water level of the pool must be raised by the addition of water until the water overflows the crest of the gutters and flushes away the debris.

5. The overflow gutter depth below the lip must be a minimum of 3 inches (8 centimeters) at the high

points between the drains. The drains must be spaced at a maximum of 15 feet (4.6 meters) between centers and a slope provided in the bottom of not less than 2 1/2 inches in 10 feet (2 percent). The gutters must be of sufficient size and shape so that floating matter entering them will not be washed back into the pool. The branch piping to each overflow gutter drain must not be less than 2 inches (5 centimeters).

6. The outlet fittings must have a clear opening in the grating at least equal to 1 1/2 times the cross sectional area of the outlet. Where large gutters are used, they must be designed to prevent entrance or entrapment of bathers' arms or legs.

7. The opening into the gutter beneath the coping must be not less than 4 inches (10 centimeters) and the interior of the gutter must be not less than 3 inches (8 centimeters) wide.

8. Disposal of water from the overflow gutters may be either to waste or may enter the recirculation system. All overflow gutters connected to the recirculation system must be connected in an approved manner, such as a surge tank.

9. The gutter must be capable of removing 50 percent or more of the recirculated water and returning it to the recirculation system.

[Bd. of Health, Public Bathing Places Reg. Art. 26 §§ 26.9-26.9.8, eff. 5-21-74]—(NAC A 11-1-88)

NAC 444.168 Skimmers. ([NRS 439.200](#), [444.070](#))

1. Each pool must be provided with at least one skimmer for each 400 square feet (37.2 square meters), or fraction thereof, of the pool area.

2. There must be no fewer than two skimmers in every pool.

3. Any skimmer used in a pool must be designated by the NSF International as complying with all applicable requirements of Standard 50, "Circulation System Components and Related Materials for Swimming Pools, Spas/Hot Tubs," of the NSF International or in the absence of applicable requirements, be approved by the health authority. A copy of this standard may be obtained from the NSF International, P.O. Box 130140, Ann Arbor, Michigan 48113, at a cost of \$45.

4. The total capacity of all skimmers used must be a minimum of two-thirds of the required filter flow. Piping for skimmers used must be designed for a capacity of at least 80 percent of the required filter flow of the recirculation system, and in no case less than 30 gallons per minute (113.6 liters per minute).

5. All inlets must be spaced at least 5 feet (1.5 meters) away from any skimmer.

6. One skimmer must be placed at a point in the pool opposite the direction of prevailing summer winds.

7. All skimmers used must be equipped with an approved equalizer valve and an equalizer line with an inside diameter of not less than 2 inches (5.08 centimeters), installed not less than 12 inches (30.48 centimeters) below the normal operating level of the water. The inlet to the equalizer line or lines must be designed to prevent the creation of a holding force whenever the body or limb of a bather comes into contact with the inlet. The inlet must be protected by a grill or shroud that will prevent a bather or any limb of a bather from entering the inlet.

[Bd. of Health, Public Bathing Places Reg. Art. 26 §§ 26.10-26.10.3, eff. 5-21-74]—(NAC A 7-23-82; 11-1-88; 1-16-96)

NAC 444.170 Filters. ([NRS 439.200](#), [444.070](#))

1. Any filter used in a pool must be designated by the NSF International as complying with all applicable requirements of Standard 50, "Circulation System Components and Related Materials for Swimming Pools, Spas/Hot Tubs," of the NSF International or in the absence of applicable requirements, be approved by the health authority. A copy of this standard may be obtained from the NSF International, P.O. Box 130140, Ann Arbor, Michigan 48113, at a cost of \$45. Flow rates for filters must not exceed those listed by the NSF International Standard.

2. The filter plant must be provided with influent pressure gauge.

3. The filter plant must be provided with a means for draining all filter units and piping, so that all parts of the system may be drained to prevent damage from freezing where so required.

[Bd. of Health, Public Bathing Places Reg. Art. 27, eff. 5-21-74]—(NAC A 7-23-82; 11-1-88; 1-16-96)

NAC 444.172 Strainers. ([NRS 439.200](#), [444.070](#))

1. The recirculation system must include a strainer to prevent hair, lint and other solids from reaching

the pump and filters.

2. Strainers must be corrosion resistant with openings not more than one-eighth of an inch in size providing a free flow area at least four times the area of the pump suction line and must be readily accessible for frequent cleaning. Valves must be installed adjacent to the strainer in order that the flow may be shut off during the cleaning or inspection. At least one spare strainer basket must be provided.

3. Strainers may not be required in systems using vacuum diatomaceous earth filters.

[Bd. of Health, Public Bathing Places Reg. Art. 26 § 26.5, eff. 5-21-74]

NAC 444.174 Vacuum cleaners. ([NRS 439.200](#), [444.070](#))

1. A vacuum cleaning system is required at each public bathing or swimming facility having a pool. It must be either a portable type or an integral part of the recirculation system.

2. There must be sufficient suction and capacity to remove all normal accumulations from the floor of the pool.

3. If the vacuum cleaner is an integral part of the recirculation system, sufficient connections must be located in the walls of the pool, at least 8 inches (20 centimeters) below the water level. The vacuum cleaner may be connected to the skimmers.

4. Water vacuumed from outdoor pools and from pools with considerable sediment must be discharged to waste.

5. Any visible dirt on the bottom or sides of the pool, and any visible scum or floating matter on the surface of the pool must be removed before the pool is used.

[Bd. of Health, Public Bathing Places Reg. Art. 28, eff. 5-21-74]—(NAC A 11-1-88)

NAC 444.176 Disposal of waste. ([NRS 439.200](#), [444.070](#))

1. Provision must be made to dispose of material cleaned from filters and of backwash water in a manner that will not create a nuisance.

2. If drainage to a sanitary sewer or storm sewer is permitted, an air gap must be provided which will positively preclude against surge or backflow introducing contaminated water into the pool or the recirculation system.

3. Diatomaceous earth must be disposed of so that no solids appear in the wastewater. This may be done by using a separation tank, receiving chamber, or any other method approved by the health authority.

[Bd. of Health, Public Bathing Places Reg. Art. 23, eff. 5-21-74]—(NAC A 7-23-82; 11-1-88)

NAC 444.178 Disinfectants: Approval of use of chemical feeders and other disinfecting materials and methods. ([NRS 439.200](#), [444.070](#))

1. A public bathing or swimming facility must be equipped with a chlorinator, hypochlorinator or other disinfectant feeder. Except as otherwise provided in subsections 2 and 3, chemical feeders and process equipment, other than compressed chlorine gas feeders, must be designated by the NSF International as complying with all applicable requirements of Standard 50, "Circulation System Components and Related Materials for Swimming Pools, Spas/Hot Tubs," of the NSF International or in the absence of applicable requirements, be approved by the health authority. A copy of this standard may be obtained from the NSF International, P.O. Box 130140, Ann Arbor, Michigan 48113, at a cost of \$45.

2. The health authority may approve other feeders if the operator of the facility demonstrates to the health authority that the required residual concentrations of disinfectant can be maintained using the feeder.

3. Chemical feeders must be capable of supplying not less than the equivalent of 3 pounds (1.4 kilograms) of chlorine for outdoor pools, or 1 pound (454 grams) of chlorine in the case of an indoor facility, per 10,000 gallons (37,850 liters) of facility capacity during a 24-hour period.

4. The health authority may approve other disinfecting materials or methods if the operator of the facility demonstrates to the satisfaction of the health authority that they provide a satisfactory residual effect which is easily measured and are as effective at disinfecting as the use of the chlorine concentrations required in [NAC 444.148](#).

5. Disinfectant feeders must be installed to ensure that the flow of the chemical disinfectant will stop immediately if there is an interruption in the flow of water to the pool or through the disinfection system.

[Bd. of Health, Public Bathing Places Reg. Art. 29, §§ 29.1-29.1.2, eff. 5-21-74]—(NAC A 9-17-82; 11-1-

88; 1-16-96)

NAC 444.180 Disinfectants: Use of chlorine gas. ([NRS 439.200](#), [444.070](#)) An owner of a public bathing or swimming facility who obtained his or her operating permit on or after January 16, 1996, may not use compressed chlorine gas to sanitize or disinfect the facility. An owner of a public bathing or swimming facility who obtained his or her operating permit before January 16, 1996, may use compressed chlorine gas to sanitize the facility if the following features are provided:

1. The cylinders of chlorine, the scale required by subsection 15 and the chlorinator must be kept above grade in a separate, well-ventilated, reasonably gastight and corrosion-resistant enclosure.
2. The enclosure must be provided with vents near the floor which terminate outdoors through an airtight duct at a point where chlorine gas will not sink into spaces below the surface of the ground. Mechanical ventilation must be used. The exhaust system must be capable of providing not less than two air changes per hour in the enclosure and comply with applicable building and fire codes.
3. The door to the enclosure must not open into the pool enclosure and must open outward. All enclosures must be equipped with a quick exit door push bar. The enclosure must be equipped with a key locked latch, with the key lock located on the outside of the enclosure. The enclosure must be locked at all times except when personnel are inside.
4. An observation window must be provided in the wall or door of the enclosure that provides a good view of the inside of the enclosure and is not less than 18 square inches (116.14 square centimeters) in size. Artificial illumination of at least 20 foot-candles must be provided to permit the observation and maintenance of the equipment in the enclosure.
5. Switches for the operation of the exhaust fan and the artificial illumination must be located on the outside of the enclosure and near the door.
6. The floor area of the enclosure must be of adequate size to house the chlorinator.
7. The chlorinator must be of rugged design, capable of withstanding wear without developing leaks.
8. Chlorine cylinders must be anchored to prevent their falling over. A valve stem wrench or valve handle must be maintained on the chlorine cylinder so the supply of gas can be shut off quickly in the case of an emergency. The valve protection hood must be kept in place except when the cylinder is in operation.
9. The chlorine feeding device must be vacuum operated and designed so that during accidents or interruptions of the water supply, or break in the system, the feeder positively and automatically shuts off the supply of chlorine gas and vents any leaking gas outside the enclosure at a safe point of discharge. The enclosure must be equipped with an acceptable and properly functioning device, with an audible alarm, to detect chlorine leakage. A leakage test kit consisting of ammonia water and a sponge swab must also be provided.
10. The chlorinator must be a solution feed type, capable of delivering chlorine at its maximum rate without releasing chlorine gas into the equipment room. Pressure vacuum relief vents must discharge to the outside atmosphere in a safe area.
11. The temperature of the chlorine metering equipment must not fall below 55°F (12.8°C). A means to keep the temperature above that level must be provided and used.
12. The chlorinators must be designed to prevent the backflow of water into the chlorine solution container.
13. A gas mask designed for use in a chlorine atmosphere and of a type approved by the appropriate federal agency must be located outside of the enclosure in a closed, unlocked cabinet. A replacement canister for use with the mask and a record book for recording any use of the mask must also be kept in the cabinet.
14. A placard must be posted on the outside of the enclosure that describes the first-aid measures for treating victims of chlorine exposure and includes the telephone number of the supplier of chlorine gas.
15. A scale or other suitable device must be provided so that the amount of chlorine gas contained in the cylinder can be determined.
16. A sign or placard stating "CAUTION - CHLORINE GAS" must be placed on the door to the chlorinator room in a location where it is readily visible to any person approaching the door.
17. Chlorine or chlorination equipment must not be located in a building which houses sleeping guests.
18. Facilities that use gas chlorination must employ personnel trained to the satisfaction of the health authority in the safe handling of chlorine and in the operation and maintenance of chlorination equipment.

These personnel must be available at all times that the facility is open to ensure the safety of employees and visitors.

19. Gas chlorine cylinders must not be stored in areas where they are exposed to direct sunlight or are readily accessible to unauthorized persons.

[Bd. of Health, Public Bathing Places Reg. Art. 29 §§ 29.2-29.2.17, eff. 5-21-74]—(NAC A 11-1-88; 1-16-96)

NAC 444.182 Disinfectants: Handling; storage; toxicity. ([NRS 439.200](#), [444.070](#))

1. The hand dosing of disinfectant or the introduction of disinfectant at a public bathing or swimming facility by means other than through a chemical feeder which has been approved by the health authority is not permitted except for superchlorination, superbromination or for bringing the residual of the disinfectant up to required levels when the facility is closed. No swimmers may use the facility until the residual of the disinfectant has dropped to the level required by [NAC 444.148](#).

2. Adequate facilities for storing chemicals must be provided at all public bathing or swimming facilities. Chemicals must be stored in accordance with the instructions of the manufacturer or, in the absence of such instructions, as directed by the health authority.

3. Chemicals used in controlling the quality of water must be demonstrated to impart no toxic properties to the water. Chemicals used for the control of algae must be approved for that use by the health authority.

4. If the water in a facility cannot be maintained at a pH of 7.0 to 8.0, equipment for the feeding of chemicals to maintain the required pH must be provided. Equipment and piping used to apply chemicals to the water must be of such size, design and material that they may be cleaned and be free from clogging. All material used for such equipment and piping must be resistant to the action of the chemicals to be used in them.

[Bd. of Health, Public Bathing Places Reg. Art. 29 §§ 29.3-29.6, eff. 5-21-74]—(NAC A 9-17-82; 11-1-88)

NAC 444.184 Testing equipment. ([NRS 439.200](#), [444.070](#))

1. Every public bathing or swimming facility must have an approved test set for the determination of pH, disinfectant residuals, total alkalinity and, at facilities where chlorinated cyanurates are used, cyanuric acid concentrations.

2. The use of orthotolodine for determining the level of residual disinfectant is not approved. The use of the DPD method for determining the level of residual chlorine or bromine is approved.

[Bd. of Health, Public Bathing Places Reg. Art. 21, eff. 5-21-74]—(NAC A 7-23-82; 11-1-88)

NAC 444.186 Heating units. ([NRS 439.200](#), [444.070](#)) If a pool is heated, the heating unit must be isolated or installed in a manner which ensures that bathers will not be injured because of its placement. The heating unit must be equipped with a thermostat which controls the temperature of the water. All of the parts of the heating unit must be easy to remove for cleaning.

[Bd. of Health, Public Bathing Places Reg. Art. 22 § 22.2, eff. 5-21-74]—(NAC A 9-16-92)

NAC 444.188 Equipment rooms. ([NRS 439.200](#), [444.070](#))

1. Pumps, chlorinators and other electrical equipment must be installed in a protective enclosure.

2. If any part of the equipment room is below grade, access by stairway and suitable drainage, by sump pump if necessary, must be provided. If an open stairwell is used, ventilation through a fully louvered door and a permanently open louvered vent on at least one other side of the room is required. Enclosed stairways require louvered vents on three sides of the room or an exhaust fan. The access opening must be at least 3 feet x 6 feet (0.9 x 1.8 meters).

3. Equipment must be installed so that there is adequate clearance to allow for its normal operation and maintenance. An equipment room must have space to store chemicals and auxiliary equipment.

[Bd. of Health, Public Bathing Places Reg. Art. 25, eff. 5-21-74]—(NAC A 9-17-82; 11-1-88)

Water Recreation Attractions

NAC 444.194 Consultation regarding design of attraction. ([NRS 439.200](#), [444.070](#)) The design engineer shall consult with the health authority before preparing and submitting any engineering plans or specifications for a water recreation attraction. The consultation must include a discussion of:

1. Any potential failure to comply with the provisions of [NAC 444.010](#) to [444.306](#), inclusive; and
2. Changes in the design of the attraction that may be necessary as a result of the noncompliance.

(Added to NAC by Bd. of Health, eff. 11-1-88)

NAC 444.1942 Posting signs indicating maximum depth. ([NRS 439.200](#), [444.070](#)) The operator of a water recreation attraction shall post one or more warning signs at the entrance to the attraction stating the maximum depth of water in the attraction.

(Added to NAC by Bd. of Health, eff. 11-1-88)

NAC 444.1944 Qualifications of attendants. ([NRS 439.200](#), [444.070](#), [444.115](#)) Except as otherwise provided in [NAC 444.274](#), each attendant employed at a water recreation attraction must be:

1. Certified by the Red Cross or an equivalent organization in first aid and cardiopulmonary resuscitation; and
2. Otherwise trained to deal with safety hazards related to the particular attraction at which the attendant is employed.

(Added to NAC by Bd. of Health, eff. 11-1-88)

NAC 444.1946 Plan for attendants. ([NRS 439.200](#), [444.070](#))

1. The operator of each water recreation attraction shall establish a plan for attendants at the attraction and shall submit the plan to the health authority for review and approval.

2. The plan for attendants must:

(a) Set forth in detail the manner in which lifeguards and other attendants are to be stationed;

(b) Describe training and emergency procedures;

(c) Include provisions for back-up attendants in the event of a multiple rescue; and

(d) Include any other provisions necessitated by pool depth, wave action, line of sight, bather loads or other special conditions affecting the safety of bathers.

3. Any significant change in the plan for attendants must be submitted to the health authority for review and approval before it is put into effect.

(Added to NAC by Bd. of Health, eff. 11-1-88)

NAC 444.1948 Deviation from requirements. ([NRS 439.200](#), [444.070](#)) A water recreation attraction may deviate from the requirements of [NAC 444.010](#) to [444.306](#), inclusive, if and to the extent:

1. An exemption from those requirements is necessary to accommodate the special use of the attraction; and

2. The design and construction of the attraction are within the limits of sound engineering practice and present no health or safety hazard.

(Added to NAC by Bd. of Health, eff. 11-1-88)

NAC 444.195 Water slides: Design and construction. ([NRS 439.200](#), [444.070](#))

1. A water slide must consist of one or more flumes, splash pools or slide runouts, a pump reservoir, and facilities for the filtration, disinfection and chemical treatment of water.

2. The structural design of a water slide and the materials used in its construction must conform with generally accepted structural engineering practices and must provide a sound, durable structure that will safely sustain all the dead loads, live loads, liquid hydrostatic and earth pressures encountered.

3. Any components or accessories of a water slide that come into contact with bathers must be assembled, arranged and finished so that their external surfaces and edges do not present an injury hazard to the skin of bathers under casual contact.

4. The owner of a water slide and the registered engineer who designs the slide are responsible for the safe design and construction of the entire facility.

(Added to NAC by Bd. of Health, eff. 11-1-88)

NAC 444.1952 Water slides: Flumes. ([NRS 439.200](#), [444.070](#))

1. Each flume of a water slide must be watertight. Its surfaces must be inert, nontoxic, smooth and easily cleaned.
2. If a tube-type flume is used, it must be designed or ventilated to prevent a hazardous concentration of toxic disinfectant fumes under all circumstances of operation.
3. All curves and turns in a flume must be:
 - (a) Designed so that the impact of bathers with the walls of the flume does not present a hazard; and
 - (b) Banked so that the forces on bathers keep them safely inside the flume under all foreseeable circumstances of operation. Bathers must not become airborne.
4. In curved sections of a flume, the design of the wall of the flume must cause the outward thrust of the body of the bather to be dissipated towards the centerline of the flume.
5. All slopes in a flume must be designed so that the speed of bathers does not reach a point at which a safe equilibrium of dynamic forces cannot be maintained on any curve or turn in the flume.
6. In sections of a flume where bathers can stop, provision must be made by design or modification to prevent bathers from falling out of the flume.
7. The construction, dimensions and methods of mechanical attachment of the components of a flume must provide a smooth and continuous surface through the entire length of the flume. Any misalignment of joints in a sectional flume must not exceed 1/8 inch (3.17 millimeters).
8. The walls of any flume must be designed so that the continuous and combined action of hydrostatic, dynamic and static loads, as well as normal environmental deterioration, do not damage the flume bed to the extent of creating a structural failure that presents a hazard of injury to bathers or requires frequent patch repairs that may weaken the structural strength of the flume.

(Added to NAC by Bd. of Health, eff. 11-1-88)

NAC 444.1954 Water slides: Exit from flume. ([NRS 439.200](#), [444.070](#))

1. The exit of any flume must be designed to ensure that bathers enter the splash pool or slide runoff at a safe speed and angle of entry.
2. If a slide has two or more flumes and there is a point of intersection between the centerlines of any two flumes, the distance between that point and the point of exit for each intersecting flume must not be less than 20 feet (6.08 meters), or 30 feet (9.12 meters) if any bather exits a flume at high speed.

(Added to NAC by Bd. of Health, eff. 11-1-88)

NAC 444.1956 Water slides: Exit into splash pool. ([NRS 439.200](#), [444.070](#)) If bathers exit the flume of a water slide into a splash pool:

1. The flume must be:
 - (a) Horizontal; and
 - (b) Perpendicular to the wall of the pool at the point of exit,
 - Ê for a distance of not less than 10 feet (3.04 meters) from that point.
2. The flume exit must be flush with the vertical wall of the pool at the point of exit and not more than 2 inches (5.08 centimeters) above, nor less than 6 inches (15.24 centimeters) below, the normal operating level of the pool.
3. The distance between:
 - (a) The side wall of the pool and that portion of the flume exit nearest the wall must be not less than 5 feet (1.52 meters) at the point of exit.
 - (b) The centerline of the flume and the centerline of any adjacent flume must be not less than 6 feet (1.82 meters) at the point of exit.
 - (c) The point of exit and the side of the pool opposite bathers as they exit, excluding any steps, must be not less than:
 - (1) Twenty feet (6.08 meters), if the flume ends above or below the normal operating level; and
 - (2) Thirty feet (9.12 meters) if the flume ends at the normal operating level.
4. The slide may not be used if the main drain of the pool is not clearly visible from the deck with the

flume water turned off.

(Added to NAC by Bd. of Health, eff. 11-1-88)

NAC 444.1958 Water slides: Splash pools. ([NRS 439.200](#), [444.070](#))

1. If a splash pool is used at a water slide, it must be located at the base of the slide.

2. Except as otherwise provided in this subsection, the depth in a splash pool at the end of the flume must be maintained at 3 1/2 feet (1.05 meters) from the normal operating level to the floor. This depth must be maintained for a distance of not less than 20 feet (6.08 meters) from the point of exit from the flume, or not less than 30 feet (9.12 meters) from that point if the point of exit is even with the normal operating level. The health authority may waive these requirements if a special exit system is used that ensures a safe exit from the flume and safe entry to the splash pool.

3. Beyond the area of level floor required by subsection 2, in the area of the pool opposite the point of exit from the flume, the floor of the splash pool may have a constant slope upward of not more than 1 in 7.

4. If steps are provided instead of exit ladders or stepholes with handrails, a handrail must be provided at the steps opposite the point of exit from each flume. The surface edge of the splash pool steps must be outlined in a contrasting color.

(Added to NAC by Bd. of Health, eff. 11-1-88)

NAC 444.196 Water slides: Decks. ([NRS 439.200](#), [444.070](#))

1. A deck must be provided along the exit side of the splash pool and along one or more of the other sides of the pool. The pump and reservoir area must be accessible by a deck not less than 3 feet (0.91 meters) wide.

2. All decks must be sloped at not less than 1/4 inch per foot to drains or approved surface water disposal areas.

3. If deck drains are provided, they must have an inlet opening of not less than 4 inches (10.16 centimeters) in diameter.

(Added to NAC by Bd. of Health, eff. 11-1-88)

NAC 444.1962 Water slides: Means of access. ([NRS 439.200](#), [444.070](#))

1. A concrete walkway, steps, stairway or ramp must be provided between the splash pool and the top of the flume.

2. The walkway or other means of access must not retain standing water and must:

(a) Conform to the structural requirements of the local building code.

(b) Be not less than 4 feet (1.21 meters) wide.

(c) Be provided with handrails.

(d) Have a slip-resistant finish.

(e) Be separated from the flume by a physical barrier that is located far enough from the flume to prevent it from being contacted by bathers on the flume.

(Added to NAC by Bd. of Health, eff. 11-1-88)

NAC 444.1964 Water slides: Runouts. ([NRS 439.200](#), [444.070](#))

1. Slide runouts, if used, must have an exit opening or step unless one or both walls of the runout are not more than 12 inches (30.48 centimeters) in height.

2. Runouts must be designed with adequate length and water depth and sloped so as to bring the bather to a safe stop.

(Added to NAC by Bd. of Health, eff. 11-1-88)

NAC 444.1966 Water slides: Pump reservoirs. ([NRS 439.200](#), [444.070](#))

1. Pump reservoirs used in water slides must have sufficient volume to contain not less than 2 minutes of combined flow from all water treatment and flume pumps or must contain enough water to ensure that the splash pool will maintain a constant water depth.

2. The interior of pump reservoirs must be watertight with a hard trowel or equivalent impervious, slip-

resistant finish.

3. Pump reservoirs must be accessible only to authorized persons. Intakes to the slide pump must be designed to allow cleaning without danger of trapping the operator.

(Added to NAC by Bd. of Health, eff. 11-1-88)

NAC 444.1968 Water slides: Control of water. ([NRS 439.200](#), [444.070](#))

1. A surge-free automatic water makeup system with a manual override must be provided and constructed so that the normal operating level of the splash pool is maintained at all times. Approved backflow protection must be provided.

2. The velocity of water at the weir or inlet grate must not exceed 1 1/2 feet (0.4 meters) per second.

3. A perimeter overflow gutter, if used, is not required directly under slide flumes or along the weirs that separate splash pools and pump reservoirs.

4. Surface skimming devices may be used instead of a perimeter overflow gutter.

(Added to NAC by Bd. of Health, eff. 11-1-88)

NAC 444.197 Water slides: Visitors and spectators. ([NRS 439.200](#), [444.070](#)) There must be a definite separation between the area used by visitors and spectators and that used by bathers. Visitors and spectators in street clothing may be allowed within the pool enclosure if they remain in a separate area segregated from the area used by bathers.

(Added to NAC by Bd. of Health, eff. 11-1-88)

NAC 444.1972 Water slides: Food and drink; trash. ([NRS 439.200](#), [444.070](#))

1. Food or drink must not be permitted in locker or change rooms, in the immediate area of the flumes and pools, or on the surrounding decks, stairs and walkways. Food and drink must be permitted in any visitor and spectator area or in any segregated snack area for bathers.

2. Trash containers must be provided to keep litter off the decks and walkways and out of the flumes and pools.

(Added to NAC by Bd. of Health, eff. 11-1-88)

NAC 444.1974 Water slides: Posting notice of prohibited conduct. ([NRS 439.200](#), [444.070](#)) The operator of a water slide shall post one or more warning signs at the entrance to the facility. Each sign must state that the following types of conduct are prohibited within the facility:

1. Running, standing, kneeling, rotating, tumbling or stopping in any flume or tunnel.

2. Horseplay.

3. Diving or flipping while exiting from a flume.

4. Use of the slide while under the influence of alcohol or drugs.

5. Use of a flume by more than one person at a time.

6. Failure to obey the instructions of the top pool supervisor or the lifeguard.

7. Failure to keep hands inside the flume while using the slide.

8. Failure to leave the landing pool promptly after exiting from the slide.

9. The possession of any glass, bottle or food in or near any pool.

10. Entry into an area of grass or other vegetation.

11. The possession of any toy or can.

12. The use of any clothing on the slide other than the usual swimwear.

13. Wearing any comb, bracelet, watch or other jewelry.

14. Failure to shower before using the slide.

(Added to NAC by Bd. of Health, eff. 11-1-88)

NAC 444.1976 Water slides: Precautions for safety. ([NRS 439.200](#), [444.070](#))

1. At all times while a water slide is open for use, an attendant must be on duty at each splash pool or slide runout. The attendant shall serve as the safety director of the slide. In that capacity, he or she shall control crowds, keep bathers moving through the pool or runout in an orderly fashion, and control any unsafe

behavior in the lower flumes, in the pool or runout, or on the decks near the base of the slide.

2. At all times while the slide is open for use, an attendant must be on duty at each entrance to a flume. The attendant shall control bathers near the entrance, regulate the departure of each bather down the slide and control any unsafe behavior in the upper flumes.

3. Radio communication between the flume entry attendant and the splash pool or slide runout attendant must be provided.

4. Each water slide must have a means to allow the flume entry attendant to monitor the slide exit.
(Added to NAC by Bd. of Health, eff. 11-1-88)

NAC 444.198 Activity pools. ([NRS 439.200](#), [444.070](#))

1. The recirculation and filtration systems of activity pools must have a maximum turnover cycle of 4 hours.

2. Amusement devices used in activity pools must be designed and maintained so that their surfaces are smooth, nontoxic and easily cleanable. The devices must not pose a safety or health hazard to bathers and must not interfere with circulation or disinfection of the water.

(Added to NAC by Bd. of Health, eff. 11-1-88)

NAC 444.1985 Wave pools. ([NRS 439.200](#), [444.070](#))

1. The generation of waves more than 3 feet (0.91 meters) in height in a wave pool, regardless of the depth of the pool, must not continue for more than 15 minutes at a time. When the generation of waves ends, it must be stopped for not less than 5 minutes.

2. The recirculation and filtration system of wave pools must have a maximum turnover cycle of 4 hours.

3. The wave pool must not be used if the main drain is not clearly visible from the deck with the wave generating equipment turned off.

4. Bathers must gain access to the wave pool at the shallow or beach end. The sides of the pool must be protected from unauthorized entry into the pool by the use of a fence or other comparable barrier.

5. Wave pools must be provided with handholds at the static water level. The handholds must be self-draining and must be installed so that their outer edge is flush with the pool wall. The design of the handholds must ensure that body extremities will not become entangled during wave action.

6. Life jackets must be provided free for use by bathers who request them.

7. Each permanent station for pool attendants must be provided with a clearly labeled and readily accessible emergency shut-off switch for the control of the wave action.

8. An audible warning system must be provided to alert bathers of the beginning of wave generation.

9. The area where waves are generated must be protected by a barrier having openings not more than 2 inches (5.08 centimeters) in diameter.

10. Step holes and handrails must be provided at one or more locations along the wall of the pool. The step holes and handrails must extend down the wall so that they will be easily accessible during wave generation at the lowest water level. The distance between the handrail and the wall must not exceed 6 inches (15.24 centimeters).

11. A sign stating "NO DIVING" in contrasting letters not less than 4 inches (10.16 centimeters) in height must be posted in a conspicuous place.

(Added to NAC by Bd. of Health, eff. 11-1-88)

NAC 444.199 Child amusement lagoons. ([NRS 439.200](#), [444.070](#))

1. The recirculation and filtration systems of child amusement lagoons must have a maximum turnover cycle of 1 hour.

2. Amusement devices used in child amusement lagoons must be designed and maintained so that their surfaces are smooth, nontoxic and easily cleanable. The devices must not pose a safety or health hazard to bathers and must not interfere with circulation or disinfection of the water.

(Added to NAC by Bd. of Health, eff. 11-1-88)

NAC 444.1995 Watercourse rides. ([NRS 439.200](#), [444.070](#))

1. The recirculation and filtration systems of watercourse rides must have a maximum turnover cycle of 4 hours.
2. Handrails, steps, stairs and booster inlets for watercourse rides must not protrude into the watercourse.
3. The watercourse must not be narrower than 12 feet (3.65 meters), nor deeper than 3 1/2 feet (1.06 meters).
4. An approved method of exit must be provided not less frequently than every 200 feet (60.96 meters) along the watercourse.
5. A deck must be provided on at least one side of the watercourse.
6. The design velocity of water in a watercourse ride must not exceed 2 miles per hour.
(Added to NAC by Bd. of Health, eff. 11-1-88)

Miscellaneous Facilities

NAC 444.200 Spray pools. ([NRS 439.200](#), [444.070](#))

1. The water supply for a spray pool must at all times meet the requirements relating to water set forth in [NAC 444.108](#) to [444.188](#), inclusive.
2. The spray pool must be equipped at its low point with an unvalved drain of sufficient capacity and design to prevent any accumulation of water in the pool.
[Bd. of Health, Public Bathing Places Reg. Art. 43 §§ 43.4-43.4.3, eff. 5-21-74]—(NAC A 7-23-82; 11-1-88)

NAC 444.202 Wading pools: Construction. ([NRS 439.200](#), [444.070](#))

1. A wading pool must have:
 - (a) A maximum depth of 24 inches (60 centimeters);
 - (b) A slope which does not exceed 1 in 12; and
 - (c) A slip-resistant finish.
2. A wading pool constructed after November 1, 1988, must have a maximum turnover cycle of 30 minutes. All wading pools must have a separate system for circulation. Equipment which is used to recirculate and disinfect the water and which meets the applicable requirements of [NAC 444.108](#) to [444.204](#), inclusive, must be installed and operated at wading pools which cannot maintain satisfactory water quality by using the equipment from an adjacent public bathing or swimming facility.
3. The outlets from the wading pool may be connected to a sanitary drain or returned to the recirculation system of the pool for refiltration at the suction side of the pump. A wading pool must have a waste outlet at its deepest point; so that it may be completely emptied to a sanitary drain.
4. A wading pool must have at least two inlets.
5. In general, standards of sanitation, surface skimming and all other details must be equal or superior to those set forth in [NAC 444.108](#) to [444.188](#), inclusive.
[Bd. of Health, Public Bathing Places Reg. Art. 43 §§ 43.2-43.3.5, eff. 5-21-74]—(NAC A 9-17-82; 11-1-88)

NAC 444.204 General requirements for wading pools; location of spray pools. ([NRS 439.200](#), [444.070](#))

1. Adequate sanitary toilet facilities, as determined by the health authority, must be available in the vicinity of the pool.
2. A sanitary drinking fountain must be provided at one side or end of the area with a raised step to enable children of all sizes to drink without assistance.
3. Wading pools and spray pools must be located at the shallow end of the main pool and must be separated from it by a separate fence or barrier as described in [NAC 444.136](#).
4. Underwater lights are prohibited in wading pools.
5. Wading pools, by the nature of their usage, are likely to become polluted and a public hazard. Where installed, they must be operated very carefully to minimize the danger to public health.
[Bd. of Health, Public Bathing Places Reg. Art. 43 §§ 43.5-43.8, eff. 5-12-74]—(NAC A 11-1-88)

NAC 444.206 Special purpose pools. ([NRS 439.200](#), [444.070](#), [444.080](#))

1. Special purpose pools may deviate from the requirements of [NAC 444.010](#) to [444.306](#), inclusive, if:
 - (a) Their design and construction are within the limits of sound engineering practice and present no health or safety hazard; and
 - (b) The deviation is required because of the special use of the pools.
2. The operating permit issued for a special purpose pool must denote that it is for such a pool and must state the purpose for which the pool is to be used.
3. The health authority shall require such measures as he or she deems necessary to ensure the health and safety of bathers using a special purpose pool.
(Added to NAC by Bd. of Health, eff. 11-1-88)

NAC 444.207 Isolation and flotation tanks. ([NRS 439.200](#), [444.070](#))

1. The recirculation, filtration and disinfection systems of isolation and flotation tanks must complete no fewer than four turnover cycles between users of the tank.
2. The maximum bathing load in a tank is one person.
3. The solution in the tank must be disinfected by normal chlorination or bromination at 3.0 to 5.0 ppm.
4. Notices must be posted in the vicinity of the tank in the manner and with the information required by [NAC 444.530](#).
5. The maximum temperature of the solution in the tank must not exceed 95°F (35°C).
6. The tank must be designed or ventilated to prevent any hazardous concentration of fumes from toxic disinfectants under all circumstances of operation.
(Added to NAC by Bd. of Health, eff. 11-1-88)

NAC 444.208 Artificial swimming lagoons. ([NRS 439.200](#), [444.070](#))

1. The design engineer shall consult with the health authority before the preparation and submission of any engineering plans or specifications for an artificial swimming lagoon.
2. An artificial swimming lagoon may deviate from other provisions of [NAC 444.010](#) to [444.306](#), inclusive, if its design and construction are within the limits of sound engineering practice and present no health or safety hazard.
(Added to NAC by Bd. of Health, eff. 11-1-88)

Bathhouses**NAC 444.210 Required facilities.** ([NRS 439.200](#), [444.070](#))

1. Dressing facilities, shower facilities and drinking fountains conforming to the minimum requirements of this section must be provided for each public bathing or swimming facility except where the users of the facility have access to showers, toilet and dressing facilities in adjacent living quarters or such facilities are otherwise available for use by all persons who may use the facility.
2. These facilities must be under the general supervision of the owner of the public bathing or swimming facility.
3. As used in this section:
 - (a) "Adjacent" means that not more than 10 percent of bathers will have to travel more than 300 feet (91.4 meters) to sanitary facilities.
 - (b) "Living quarters" includes any hotel, motel or other place of lodging, or a trailer park, apartment, condominium or other facility containing multiple dwellings.
4. For distances greater than that provided in paragraph (a) of subsection 3, the following minimum sanitary facilities must be provided in the bath house:

Men: 1 water flush toilet
1 lavatory

Women: 1 water flush toilet
1 lavatory

1 shower

1 shower

[Bd. of Health, Public Bathing Places Reg. Art. 42 §§ 42.1 & 42.1.1-42.1.2, eff. 5-21-74]—(NAC A 7-23-82; 11-1-88)

NAC 444.212 General requirements. ([NRS 439.200](#), [444.070](#))

1. The rooms of bathhouses must be well lighted, drained, ventilated and of good construction, with impervious materials employed in general. They must be finished in light colors and so developed and planned that good sanitation can be maintained throughout the building at all times.

2. Every bathhouse must be provided with separate facilities for each sex with no interconnection between the provisions for male and female.

3. No food, drink or glass containers are permitted in the dressing room or bath areas.

[Bd. of Health, Public Bathing Places Reg. Art. 42 §§ 42.2.2, 42.2, 42.3 & 42.18, eff. 5-21-74]—(NAC A 7-23-82; 11-1-88)

NAC 444.214 Minimum sanitary plumbing facilities. ([NRS 439.200](#), [444.070](#))

1. Minimum sanitary plumbing facilities must be provided at each public bathing or swimming facility as follows:

(a) For males: One water flush toilet, two water flush urinals and one lavatory is presumed adequate for the first 100 bathers. One water closet, one urinal and one lavatory must be provided for each additional 100 bathers or major fraction thereof. Not less than two shower heads must be provided which will be assumed to be adequate for the first 80 bathers. One additional shower head must be provided for each additional 40 bathers.

(b) For females: Not less than three water flush toilets and one lavatory must be provided which will be assumed to be adequate for the first 100 bathers. Two water closets and one lavatory must be provided for each additional 100 bathers or major fraction thereof. Not less than two shower heads must be provided which is presumed to be adequate for the first 80 bathers. One shower head must be added for each 40 additional bathers.

(c) Fixture schedules should be increased for facilities at schools or other similar locations where bather loads may reach peaks due to schedules of use.

2. These minimum criteria for bathhouse plumbing facilities are based upon the anticipated maximum attendance in bathers.

3. The requirements of this section do not apply to any swimming pool operated solely for and in conjunction with a hotel, motel or other place of lodging, or a trailer park, apartment, condominium or other facility containing multiple dwellings.

[Bd. of Health, Public Bathing Places Reg. Art. 42 §§ 42.4-42.4.4, eff. 5-21-74]—(NAC A 11-1-88)

NAC 444.216 Plumbing requirements. ([NRS 439.200](#), [444.070](#))

1. At least one drinking fountain must be made available to bathers at a public bathing or swimming facility. A raised step must be provided to enable children of all sizes to drink from the fountain without assistance.

2. All water provided for drinking fountains, lavatories and showers must be potable and meet the requirements and conform with the standards of the Health Division for drinking water.

3. Heated water must be provided at all shower heads. The water heater and thermostatic mixing valve must be inaccessible to bathers and must be capable of providing 3 gallons (11.4 liters) per minute per shower head of not less than 90°F (32°C) water. The showers must be so designed that a proper mixture of hot and cold water may be obtained without danger of scalding the bather.

4. Hose bibs must be provided for flushing down the dressing rooms and the interior of the bathhouse.

[Bd. of Health, Public Bathing Places Reg. Art. 42 §§ 42.7, 42.8, 42.11 & 42.16, eff. 5-21-74]—(NAC A 11-1-88)

NAC 444.218 Floors. ([NRS 439.200](#), [444.070](#))

1. Floors of the bathhouse must be of smooth finished material with a slip-resistant surface and impervious to moisture. Junctions between walls and floors must be covered.

2. Floor drains must be provided to ensure positive drainage of all parts of the building with a slope in the floor of not less than 1/4 inch per foot (2 percent), toward drains.

[Bd. of Health, Public Bathing Places Reg. Art. 42 §§ 42.9 & 42.10, eff. 5-21-74]—(NAC A 11-1-88)

NAC 444.222 Furnishings. ([NRS 439.200](#), [444.070](#))

1. All furniture must be of simple character and easily cleanable. Locker compartments, furniture, partitions and other appurtenances in dressing rooms must be so installed so as to permit thorough cleaning and flushing of the floor.

2. All partitions between portions of the dressing room areas, screen partitions, shower, toilet and dressing room booths must be of durable material not subject to damage by water and must be designed so that a water way is provided between the partitions and floor to permit thorough cleaning of the floor area with hoses and brooms.

3. Dispensers for providing soap must be provided at each lavatory and shower head. The dispensers must be all metal or plastic type. The use of glass in these is not permitted. Paper towels must be provided for users of the lavatories.

4. Mirrors of unbreakable material must be provided over each lavatory, and toilet paper holders, with toilet paper, must be provided at each water closet combination.

5. All light fixtures must be adequately shielded to prevent injury to bathers.

[Bd. of Health, Public Bathing Places Reg. Art. 42 §§ 42.2.3 & 42.13-42.15, eff. 5-21-74]—(NAC A 11-1-88)

NAC 444.224 Entrances and exits. ([NRS 439.200](#), [444.070](#))

1. The entrance to any pool, except a splash pool, in a public bathing or swimming facility must be located at or near the shallow end of the pool.

2. An emergency fire exit must be provided in the fence or structure enclosing the pool area, and this exit must be plainly marked. A suitable fire extinguisher must be maintained in the checking stand.

3. The entrances and exits to the dressing areas must be screened to break the line of sight.

[Bd. of Health, Public Bathing Places Reg. Art. 42 §§ 42.2.1, 42.3.1 & 42.17, eff. 5-21-74]—(NAC A 11-1-88)

NAC 444.226 Steps not permitted. ([NRS 439.200](#), [444.070](#))

1. No difference in elevation, requiring steps, may exist in the interior of male or female dressing areas.

2. No steps are permitted between the bathhouse and the adjoining deck areas. If it is necessary that the bathhouse floor be at a different elevation than the deck, ramps must be provided at the access doors. Where ramps are used between the bathhouse and the deck, the slope may not exceed 3 inches per foot (25 percent) and must be positively slip-resistant.

[Bd. of Health, Public Bathing Places Reg. Art. 42 §§ 42.12 & 42.12.1, eff. 5-21-74]—(NAC A 11-1-88)

NAC 444.228 Ventilation. ([NRS 439.200](#), [444.070](#))

1. Indoor pools, shower rooms, dressing rooms, and toilets of all public bathing or swimming facilities and natural bathing places must be properly ventilated. The ventilating system for indoor pools must be so designed as to prevent direct drafts on the bathers.

2. All interior rooms must be ventilated so that they do not remain excessively damp.

3. Toilet rooms must be ventilated to the outside so that no odor nuisance may develop.

[Bd. of Health, Public Bathing Places Reg. Art. 33, eff. 5-21-74]—(NAC A 11-1-88)

Mineral Baths, Therapeutic Pools and Similar Facilities

NAC 444.230 Applicability. ([NRS 439.200](#), [444.070](#)) Any public bath containing water for the immersion of the body or providing a hot vapor environment for whatever effect, other than a public spa as

defined by [NAC 444.385](#), must comply with the provisions of [NAC 444.230](#) to [444.236](#), inclusive.

[Bd. of Health, Public Bathing Places Reg. Art. 45 §§ 45.1 & 45.10, eff. 5-21-74]—(NAC A 7-23-82; 11-1-88)

NAC 444.232 Water quality. ([NRS 439.200](#), [444.070](#))

1. The water in such baths must be maintained free of disease organisms and must be provided under one of the following conditions:

(a) The water must be purified by recirculation in accordance with the provisions of [NAC 444.152](#) to [444.170](#), inclusive.

(b) The bath may be used exclusively by one person after which the basin must be drained, the walls scrubbed and disinfected, and then refilled.

(c) The bath water must be exchanged by flow-through of unused water so as to provide a complete change of water in 1 hour or less if the basin has a capacity of less than 1,000 gallons (3,785 liters), or in 2 hours or less if the basin has a capacity of 1,000 gallons (3,785 liters) or more.

(d) In all instances the bath lining must be of cleanable, impervious construction, and must be kept clean.

2. Potable drinking water must be supplied to the premises.

[Bd. of Health, Public Bathing Places Reg. Art. 45 §§ 45.2-45.2.4 & 45.6, eff. 5-21-74]

NAC 444.234 Temperature. ([NRS 439.200](#), [444.070](#))

1. The maximum recommended temperature in such baths is 104°F (40°C).

2. Signs which state that extended exposure to the hot water or vapors may be detrimental to the health of persons with heart conditions must be posted.

[Bd. of Health, Public Bathing Places Reg. Art. 45 §§ 45.8 & 45.9, eff. 5-21-74]—(NAC A 7-23-82)

NAC 444.236 Required facilities. ([NRS 439.200](#), [444.070](#))

1. Toilet facilities must be provided, separate for each sex, unless individual facilities are provided for each unit. The toilet rooms and fixtures must be of cleanable construction and must be kept clean.

2. Shower facilities must be provided, separate for each sex, unless individual facilities are provided for each bath unit. The shower units must be of cleanable construction, free of cracks and crevices and must be kept clean. Each person must be required to take a shower bath with soap prior to entering a bath which is to be occupied by more than one person.

3. Where resting rooms, dressing rooms or reclining facilities are provided, they must be kept clean. Floors, walls and ceiling must be of good construction and must be kept in good repair.

4. All appurtenances to the bath facility must be of cleanable construction and must be kept clean.

[Bd. of Health, Public Bathing Places Reg. Art. 45 §§ 45.3-45.5 & 45.7, eff. 5-21-74]

Natural Bathing Places

NAC 444.240 Permit required. ([NRS 439.200](#), [444.070](#), [444.080](#)) A permit to operate a natural bathing place on any waters of this State must be obtained from the health authority. Acceptability as a public bathing place will be based on the provisions of [NAC 444.242](#).

[Bd. of Health, Public Bathing Places Reg. Art. 46 § 46.1, eff. 5-21-74]

NAC 444.242 Standards for approval. ([NRS 439.200](#), [444.070](#))

1. Approval of public bathing beaches will be based upon the result of a sanitary survey of the site and the results of the bacteriological and chemical analysis of the water in the bathing area.

2. The flow of water supplying a bathing beach or the volume of water in a body of water on which a beach is located must be sufficient to provide at least 500 gallons (1,853 liters) of water per bather when the greatest number of bathers are in the water.

3. Evidence of human-caused pollution, floating debris, sludge accumulation and similar gross pollutants will disqualify the site as an acceptable bathing area until such pollutants are completely and permanently eliminated.

4. There must be a minimum of 40 square feet (3.7 square meters) of beach area per bather.

5. The slope of the bottom of the beach area must be gradual and be such as to not create a safety hazard to the user of the beach. The area floor must be free of glass, tin cans and other hazards.

6. Because each natural bathing place presents conditions different from all other natural bathing places, the health authority may apply, waive or modify these provisions as it feels best serves the public health.

[Bd. of Health, Public Bathing Places Reg. Art. 46 §§ 46.2-46.3 & 46.10, eff. 5-21-74]—(NAC A 7-23-82)

NAC 444.246 Notices and markers. ([NRS 439.200](#), [444.070](#))

1. Areas of excessive depths, containing rocks, near steep banks, or other areas which might be considered a potential hazard to the users must be adequately marked with buoys, poles or other markers so as to warn users.

2. The outer safe limits or boundary of the bathing area must be marked with buoys or other markers visible to bathers and spaced at not more than 100 feet (30.5 meters) apart.

3. Signs must be placed at the ends of each beach to define the area within which bathing is allowed and lifesaving facilities furnished. The sign “No Lifeguard Service Beyond This Point” must be installed at each end of the beach.

[Bd. of Health, Public Bathing Places Reg. Art. 46 §§ 46.7, 46.8 & 46.16, eff. 5-21-74]

NAC 444.248 Required facilities. ([NRS 439.200](#), [444.070](#))

1. Sanitary facilities must be provided in proportion to the anticipated bathing load. These must include:

- (a) Toilet and hand washing facilities and dressing rooms clearly marked for each sex;
- (b) A safe and approved water supply; and
- (c) Drinking fountains, soap and toilet tissue.

2. Conveniently located rubbish containers must be provided. These containers must be emptied whenever necessary and be kept in a sanitary condition.

3. Where night bathing is permitted, adequate lighting must be provided for the bathhouses and bathing area.

4. There must be telephone connections and transportation facilities available for emergency use.

[Bd. of Health, Public Bathing Places Reg. Art. 46 §§ 46.4-46.6 & 46.11, eff. 5-21-74]

NAC 444.250 Lifeguards. ([NRS 439.200](#), [444.070](#))

1. There must be at least one lifeguard on duty for each 400 feet (122 meters) of beach front or major fraction thereof.

2. One lifeguard tower must be provided for each 600 feet (183 meters) of beach front or major fraction thereof. Each lifeguard tower must be equipped with a 20 inch (51 centimeter) lifesaving ring with 100 feet (30.5 meters) minimum of line, and a torpedo buoy with 50 feet (15.2 meters) of line.

3. The lifeguard must have the qualifications stated in [NAC 444.274](#). If bathing is permitted beyond a depth of 5 feet (1.5 meters), a suitable boat equipped with a life ring, oars, and oarlocks or a paddle board must be provided for each 1,000 feet (304.8 meters) of beach or major fraction thereof.

4. At least one lifeguard must be stationed on the tower at all times while other lifeguards may be patrolling on the beach or in boats.

[Bd. of Health, Public Bathing Places Reg. Art. 46 §§ 46.12-46.15, eff. 5-21-74]

NAC 444.252 When bathing prohibited. ([NRS 439.200](#), [444.070](#)) Bathing must not be permitted during time of undue turbidity caused by natural occurrences or during electrical storms.

[Bd. of Health, Public Bathing Places Reg. Art. 46 § 46.9, eff. 5-21-74]

Operation

NAC 444.258 Operating permits. ([NRS 439.200](#), [444.070](#), [444.080](#))

1. No public bathing or swimming facility or natural bathing place may operate unless the operator has applied for and received an operating permit from the health authority.

2. Permits expire on January 1 of each year, unless previously revoked for a violation of the statutes and

the regulations of the State Board of Health or the local board of health. The health authority will exercise the right to close facilities and bathing places not operating in conformity with those regulations.

3. A temporary permit may be issued in exceptional cases for a limited time to permit management to make changes to comply with the minimum requirements if sufficient safeguards are enforced to protect the health and safety of the public.

4. The permit must be posted in a conspicuous place at or near the office of each facility or bathing place. In addition, placards directing the behavior of bathers must be prominently posted in locker rooms, offices, showers, toilets or elsewhere about the facility or bathing place.

[Bd. of Health, Public Bathing Places Reg. Art. 3, eff. 5-21-74]—(NAC A 11-1-88)

NAC 444.259 Fees for permits and review of plans. ([NRS 439.150](#), [439.200](#), [444.070](#), [444.080](#))

1. The Health Division shall charge and collect \$402 for each annual permit to operate a public bathing or swimming facility or natural bathing place, except in areas where the laws and regulations governing such facilities and bathing places are administered by local health authorities.

2. The Health Division shall charge and collect \$325 for reviewing plans for a new public bathing or swimming facility or natural bathing place, except in areas where the laws and regulations governing such facilities and bathing places are administered by local health authorities.

3. The Health Division shall charge and collect \$262.50 for reviewing plans for a remodeled public bathing or swimming facility or natural bathing place which has a permit, except in areas where the laws and regulations governing such facilities and bathing places are administered by local health authorities.

(Added to NAC by Bd. of Health, eff. 7-23-82; A 7-22-87; 11-1-88; 8-31-89; 1-16-96; R193-03, 1-22-2004; R100-07, 10-31-2007)

NAC 444.260 Instructions on operation and maintenance of facilities and equipment. ([NRS 439.200](#), [444.070](#)) Upon the completion of any public bathing or swimming facility, the owner and his or her operators must be given complete written and oral instructions by the contractor in the operation of the facility and all of its equipment, in the maintenance of the water used in the facility, and specifically in the details of maintenance of the equipment. All valves must be permanently tagged and a valve operating schedule must be provided for every operation.

[Bd. of Health, Public Bathing Places Reg. Art. 44, eff. 5-21-74]—(NAC A 11-1-88)

NAC 444.262 Supervision and maintenance of facilities. ([NRS 439.200](#), [444.070](#))

1. Supervision must be present at all times a wading pool is in use.

2. Every public bathing or swimming facility must be maintained under the supervision of a qualified operator who is responsible for the sanitation and safety of the facility and for the maintenance of its equipment and records.

3. The operator must demonstrate to the health authority that he or she is familiar with the function, operation and maintenance of the equipment in the facility and is capable of maintaining the water chemistry within the required limits.

[Bd. of Health, Public Bathing Places Reg. Art. 38 §§ 38.1, 38.2 & 43.1, eff. 5-21-74]—(NAC A 11-1-88)

NAC 444.263 Use of covers and solar blankets. ([NRS 439.200](#), [444.070](#))

1. A swimming pool cover or solar blanket may be used only if the pool is closed, unless the cover or blanket:

(a) Is secured around its entire perimeter; and

(b) Is designed to support and is capable of supporting the live load of one adult person.

2. Except as otherwise provided in subsection 1, unauthorized persons must not be permitted in the pool area while a pool cover or solar blanket is in use.

(Added to NAC by Bd. of Health, eff. 11-1-88)

NAC 444.264 Records. ([NRS 439.200](#), [444.070](#))

1. A written record of all data pertaining to the operation and sanitation of each public bathing or

swimming facility and natural bathing place must be maintained by the management and kept at all times available to the health authority.

2. The operator shall initial the record and the record must include, as appropriate for the facility or bathing place:

- (a) The daily attendance;
 - (b) The amounts of various chemicals used daily;
 - (c) The approximate amount of fresh water added daily;
 - (d) The daily water temperature;
 - (e) The results of chemical and bacteriological tests;
 - (f) The time and date of emptying and cleaning any pool or backwashing filters;
 - (g) Recirculation operating time;
 - (h) The names of all attendants; and
 - (i) Any other information which the health authority may require from time to time.
- [Bd. of Health, Public Bathing Places Reg. Art. 5, eff. 5-21-74]—(NAC A 11-1-88)

NAC 444.266 Lifesaving equipment. ([NRS 439.200](#), [444.070](#))

1. Not less than one unit of lifesaving equipment must be provided at every public bathing or swimming facility or natural bathing place. One unit of lifesaving equipment consists of:

- (a) A rescue tube or a ring buoy with a minimum outside diameter of 20 inches (50 centimeters) to which there must be attached a length of 1/4-inch (0.6-centimeter) rope, not less than 1 1/2 times the maximum width of the pool or swimming area; and
- (b) A life pole or shepherd's crook type of pole with minimum handle length of 12 feet (3.7 meters).

2. One unit is presumed to be adequate for 2,000 square feet (185.8 square meters) of pool or swimming area, and one additional unit must be provided for each additional 2,000 square feet (185.8 square meters), or major fraction thereof of pool or swimming area.

3. Lifesaving equipment must be mounted in conspicuous places, distributed around the edge of the pool or swimming area, at lifeguard chairs or elsewhere, ready for use, its function plainly marked and kept in repair and ready condition. Bathers or others must not be permitted to tamper with lifesaving equipment, use it for any purpose other than its intended use or remove it from its established location.

4. Every public bathing or swimming facility and natural bathing place must be equipped with:

- (a) A standard first-aid kit, filled, ready for use and readily accessible for emergency use; and
- (b) Two or more blankets reserved for emergency use.

[Bd. of Health, Public Bathing Places Reg. Art. 37, eff. 5-21-74]—(NAC A 11-1-88)

NAC 444.268 Posting information on artificial respiration and emergency services. ([NRS 439.200](#), [444.070](#)) Diagrammatic illustrations of artificial respiration procedures must be posted at all public bathing or swimming facilities where they are clearly visible from the nearby deck and protected from the elements. Except as otherwise provided in this section, the location and telephone number of the nearest ambulance, hospital, fire or police rescue service, physician and facility operator must be kept similarly posted together with instructions that, in case of need, manual or mouth-to-mouth artificial respiration should be started immediately and continued until a physician arrives or mechanical resuscitators are applied. A telephone must be located in the vicinity of the pool enclosure, but outside of the enclosure. In lieu of the emergency telephone numbers described in this section, the number for the emergency 911 service may be posted if that emergency service is available in the geographical area of the public bathing or swimming facility.

[Bd. of Health, Public Bathing Places Reg. Art. 38 § 38.8, eff. 5-21-74]—(NAC A 11-1-88; 1-16-96)

NAC 444.270 Presence of lifeguards. ([NRS 439.200](#), [444.070](#), [444.080](#))

1. Except as otherwise provided in subsection 2, any public bathing or swimming facility, except an isolation and flotation tank, spray pool, or a mineral bath, therapeutic pool or similar facility, must have a lifeguard on duty when the facility is open for use unless it is a swimming pool and all of the following conditions are met:

- (a) The pool is operated solely for and in conjunction with a hotel, motel or other place of lodging, or a trailer park, apartment, condominium or other facility containing multiple dwellings.

- (b) The pool has a surface area of less than 2,000 square feet (185.8 square meters).
- (c) There is no fee charged, whether direct or indirect, for the use of the pool.
- (d) The use of the pool is limited to the registered guests, tenants or residents of the place of lodging or facility containing multiple dwellings and their guests.

2. Except as otherwise provided in this subsection, lifeguards are not required for a swimming pool that is not open to the general public and is owned jointly by all the residents of a development or by a homeowner’s association in which all of the members are residents. The owners of such a pool shall submit to the health authority written procedures for the supervision of bathers. The health authority must approve the procedures in writing before an operating permit for the pool may be issued. A lifeguard must be on duty if the number of people in such a pool exceeds 80 percent of the maximum number of people allowed in the pool.

[Bd. of Health, Public Bathing Places Reg. Art. 38 §§ 38.3-38.4.3 & 38.9, eff. 5-21-74]—(NAC A 9-17-82; 11-1-88)

NAC 444.272 Number of lifeguards required. ([NRS 439.200](#), [444.070](#)) If lifeguard service is provided at a public bathing or swimming facility, the number of lifeguards must be adequate to maintain continuous surveillance over the bathers. At no time may there be fewer lifeguards than guard stations if there are more than 75 persons bathing or swimming at the facility.

[Bd. of Health, Public Bathing Places Reg. Art. 38 § 38.6, eff. 5-21-74]—(NAC A 11-1-88)

NAC 444.274 Qualifications, duties and identification of lifeguards. ([NRS 439.200](#), [444.070](#), [444.115](#))

- 1. Lifeguards at a public bathing or swimming facility must have satisfactorily completed a Red Cross Advanced Lifesaving Course or the equivalent.
- 2. Lifeguards must be in full charge and must have the authority to enforce all rules and regulations pertaining to sanitation and safety.
- 3. Lifeguards on duty must not be subject to duties which will interfere with their supervision of bathers.
- 4. Lifeguards shall wear distinguishing suits or emblems, so that they may be easily identified by persons using the facility.

[Bd. of Health, Public Bathing Places Reg. Art. 38 §§ 38.5-38.5.3, eff. 5-21-74]—(NAC A 7-23-82; 11-1-88)

NAC 444.276 Notices when lifeguards not provided. ([NRS 439.200](#), [444.070](#)) If no lifeguard service is provided, a warning sign must be placed in plain view for all bathers and must state “Warning - No Lifeguard on Duty” with clearly legible letters, at least 4 inches (10 centimeters) in height. In addition, the sign must state “Children Under 14 Years Old Should Not Use Facility Without An Adult in Attendance,” and “Solo Bathing is Prohibited.”

[Bd. of Health, Public Bathing Places Reg. Art. 38 § 38.7, eff. 5-21-74]—(NAC A 11-1-88)

NAC 444.278 Capacity. ([NRS 439.200](#), [444.070](#))

1. For the purpose of determining the capacity of any pool in a public bathing or swimming facility, those portions of the pool less than 5 feet (1.52 meters) deep or from the breakpoint to the shallow end is designated as the “nonswimming” area and the portion of the pool more than 5 feet (1.52 meters) deep or from the breakpoint to the deep end is designated as the “swimming” area.

2. The maximum number of bathers permitted within the pool enclosure at one time must be based on the following formula:

$$\text{Maximum Bathing Load} = \frac{\text{Nonswimming Area (ft.}^2\text{)}}{10} + \frac{\text{Swimming Area (ft.}^2\text{)}}{24}$$

3. The health authority may make additional allowance in cases of facilities with extensive deck areas

used by patrons for lounging or sunbathing.

4. The maximum number of bathers permitted within the pool enclosure must be posted at each facility. The number must be based on the area of the facility or on the sanitary facilities which are provided. The most restrictive regulation applies.

5. The owner of the facility is responsible for seeing that the maximum capacity is not exceeded. [Bd. of Health, Public Bathing Places Reg. Art. 19, eff. 5-21-74]—(NAC A 11-1-88)

NAC 444.280 Bathers: Requirements; prohibitions. ([NRS 439.200](#), [444.070](#))

1. All bathers at a public bathing or swimming facility shall take a cleansing shower using warm water and soap and shall thoroughly rinse off all soap suds before entering or reentering the pool enclosure.

2. Persons not dressed for bathing must not be allowed in the pool.

3. Persons suffering from colds, fever, coughs, sore or inflamed eyes, any skin disease or any communicable disease or open sores or bandages must be excluded from the facility.

4. Spitting, soiling, or in any way contaminating the water, walkways, or dressing room floors in the facility must be prohibited.

5. Except as otherwise provided in [NAC 444.288](#), eating, drinking and smoking within the pool enclosure are prohibited.

6. Bringing or throwing into the water or onto walkways any objects that may in any way carry contamination, endanger safety of bathers or produce unsightliness must be prohibited.

7. No boisterous or rough play may be permitted in the water, on the walkways, diving boards, floors or platforms, or in the dressing rooms or showers.

8. Persons under the influence of liquor must not be permitted in or about the facility.

9. Public bathing or swimming facilities are for use of people only; animals must be excluded from the pool and enclosure.

[Bd. of Health, Public Bathing Places Reg. Art. 39 §§ 39.1-39.6, 39.8 & 39.9, eff. 5-21-74]—(NAC A 11-1-88)

NAC 444.282 Bathers: Failure to comply with rules and regulations. ([NRS 439.200](#), [444.070](#)) Any person who refuses to comply with any regulation governing a public bathing or swimming facility or any rule of that facility must be excluded from the premises, and the management shall promptly bring any action which may be necessary to prosecute or eject from the premises any such person.

[Bd. of Health, Public Bathing Places Reg. Art. 39 § 39.7, eff. 5-21-74]—(NAC A 11-1-88)

NAC 444.284 Swimming suits and towels. ([NRS 439.200](#), [444.060](#))

1. Swimming suits and towels furnished by the management, unless sent to a public laundry, must be washed with hot water and soap or detergent, rinsed and thoroughly dried and sterilized by heat each time they are used, or an equivalent, approved process must be used.

2. Clean swimming suits and towels must not be permitted to come in contact with unwashed suits and towels or be stored on shelves or in baskets which have been used for storing dirty swimming suits and towels.

3. Clean suits and towels must not be issued at the same counters where dirty towels and suits are returned.

[Bd. of Health, Public Bathing Places Reg. Art. 41 §§ 41.1-41.2.1, eff. 5-21-74]

NAC 444.286 Bathing caps. ([NRS 439.200](#), [444.070](#)) Any person with long hair who uses a public bathing or swimming facility shall wear an acceptable bathing cap if required to do so by the management of the facility. The use of common bathing caps is prohibited.

[Bd. of Health, Public Bathing Places Reg. Art. 41 § 41.3, eff. 5-21-74]—(NAC A 11-1-88)

NAC 444.288 Food and drinks. ([NRS 439.200](#), [444.070](#)) Food or drinks are not permitted in a public bathing or swimming facility, except in the visitor area or in areas which have been approved by the health authority for food or drinks.

[Bd. of Health, Public Bathing Places Reg. Art. 40, eff. 5-21-74]—(NAC A 9-17-82; 11-1-88)

NAC 444.290 Spectators and nonbathers. ([NRS 439.200](#), [444.070](#)) Except as otherwise provided in this section, spectators and nonbathers must be excluded from the toilet rooms provided for the persons using a public bathing or swimming facility. If the management desires to accommodate spectators and nonbathers, they must be provided with separate toilet facilities. An exception to the requirements of this section may be granted if, in the opinion of the health authority, the toilet facilities provided for bathers are also adequate to accommodate spectators and nonbathers.

[Bd. of Health, Public Bathing Places Reg. Art. 42 § 42.6, eff. 5-21-74]—(NAC A 11-1-88)

Violations

NAC 444.300 Notice of violation. ([NRS 439.200](#), [444.070](#)) If the health authority inspects a public bathing or swimming facility or natural bathing place and finds a violation of any provision of [NAC 444.010](#) to [444.306](#), inclusive, that does not seriously endanger the public health, the health authority shall issue a written notice of the violation to the owner or his or her representative and allow a reasonable time for the violation to be corrected.

[Bd. of Health, Public Bathing Places Reg. Art. 4 § 4.1, eff. 5-21-74]—(NAC A 11-1-88)

NAC 444.302 Suspension or denial of operating permit. ([NRS 439.200](#), [444.070](#), [444.080](#), [444.100](#))

1. The health authority may order a suspension of an operating permit and may order the owner or operator of a public bathing or swimming facility or natural bathing place to prohibit any person from using it if the health authority finds:

(a) A failure of the equipment, structure, area or enclosure of the facility or bathing place which jeopardizes the health or safety of the persons using or operating it.

(b) That the facility or bathing place lacks properly functioning equipment or proper material for recirculating, treating or testing the water used for swimming or bathing.

(c) A lack of required supervisory personnel or required lifeguards.

(d) That the operator of the facility or bathing place is not maintaining the required water quality.

(e) That the operator does not possess a valid operating permit.

2. The health authority may deny an application for an operating permit if the applicant fails to:

(a) Notify the health authority before construction and completion of the facility;

(b) Allow inspection of the facility during or after its construction; or

(c) Follow any of the requirements set forth in [NRS 444.065](#) to [444.120](#), inclusive, and [NAC 444.010](#) to [444.306](#), inclusive.

[Bd. of Health, Public Bathing Places Reg. Art. 4 §§ 4.2-4.2.5, eff. 5-21-74]—(NAC A 11-1-88; 10-30-97)

NAC 444.304 Order for closure; revocation of suspended permit. ([NRS 439.200](#), [444.070](#), [444.100](#))

1. If the health authority orders the closing of a public bathing or swimming facility or natural bathing place, the health authority shall issue a written order to the owner or operator of the facility or bathing place, or his or her representative, stating with particularity the reason for the order of closure along with his or her finding that the condition giving rise to the order represents a serious threat to the public health and safety.

2. The order must state that the facility or bathing place is to be closed immediately and must specify the corrective action necessary before the facility or bathing place may be reopened for use.

3. The order must be served upon the owner, operator, representative or a person in charge of the facility or bathing place. The person on whom the order is served shall close the facility or bathing place immediately and shall prohibit any person from using it.

4. If the order is served upon a person whose operating permit is suspended, the health authority may take appropriate action to revoke the operating permit unless the operator:

(a) Closes the facility or bathing place immediately; and

(b) Takes any corrective action required by the order within the time therein specified.

[Bd. of Health, Public Bathing Places Reg. Art. 4 § 4.3, eff. 5-21-74]—(NAC A 11-1-88; 10-30-97)

NAC 444.305 Procedure for review of actions taken by Health Division; appeals. ([NRS 439.200](#), [444.070](#), [444.100](#))

1. A person who has reason to believe that an action taken by the Health Division pursuant to [NAC 444.010](#) to [444.306](#), inclusive, is incorrect or based on inadequate knowledge may, within 10 business days after receiving notice of the action, request an informal discussion with the employee responsible for the action and the immediate supervisor of the employee.

2. If the informal discussion does not resolve the problem, the aggrieved person may, within 10 business days after the date scheduled for the informal discussion, submit a written request to the Bureau for an informal conference. The informal conference must be scheduled for a date, place and time mutually agreed upon by the aggrieved person and the Bureau, except that the informal conference must be held no later than 60 days after the date on which the Bureau received the written request.

3. Except as otherwise provided in subsection 4, the determination of the Bureau resulting from the informal conference cannot be appealed and is the final remedy available to the aggrieved person.

4. An applicant for or holder of a permit or license issued pursuant to [NAC 444.010](#) to [444.306](#), inclusive, who is aggrieved by an action of the Health Division relating to the denial of an application for or renewal of such a permit or license or the suspension or revocation of such a permit or license may appeal that action in accordance with [NAC 439.300](#) to [439.395](#), inclusive, after exhausting the informal procedures set forth in this section, except that the Bureau may waive the informal procedures, or any portion thereof, by giving written notice to the aggrieved person.

5. As used in this section, "Bureau" means the Bureau of Health Protection Services of the Health Division or its successor.

(Added to NAC by Bd. of Health, eff. 10-30-97)

NAC 444.306 Reinspection. ([NRS 439.200](#), [444.070](#), [444.100](#))

1. After the specified corrective action has been taken, the owner or operator or his or her representative shall notify the health authority that the facility or bathing place is ready for reinspection.

2. If upon reinspection the corrective action is approved, the health authority shall order the reinstatement of the operating permit, at which time the facility or bathing place may be opened for use.

3. If upon reinspection the corrective action is not approved, the operating permit remains suspended and the facility or bathing place must be kept closed and out of use until corrective action is approved.

[Bd. of Health, Public Bathing Places Reg. Art. 4 §§ 4.4-4.6, eff. 5-21-74]—(NAC A 11-1-88)

PUBLIC SPAS

General Provisions

NAC 444.310 Definitions. ([NRS 439.200](#), [444.070](#)) As used in [NAC 444.310](#) to [444.546](#), inclusive, unless the context otherwise requires, the words and terms defined in [NAC 444.315](#) to [444.416](#), inclusive, have the meanings ascribed to them in those sections.

(Supplied in codification; A by Bd. of Health, 11-2-88; 1-16-96; 10-30-97)

NAC 444.315 "Air induction system" defined. ([NRS 439.200](#), [444.070](#)) "Air induction system" means a system activated by a separate air power unit or blower which forces air into hollow ducting built into the spa floor, bench or other part of the spa.

[Bd. of Health, Public Spa Reg. Art. 1 § 1.1, eff. 11-27-79]

NAC 444.317 "Antivortex drain" defined. ([NRS 439.200](#), [444.070](#)) "Antivortex drain" means a drain having a raised cover designed to prevent or minimize any suctioning effect on a person that has come into contact with the drain.

(Added to NAC by Bd. of Health, eff. 11-2-88)

NAC 444.318 "Approved" defined. ([NRS 439.200](#), [444.070](#)) "Approved" means acceptable to the health authority based upon a determination concerning conformance with appropriate standards and good

public health practices.

(Added to NAC by Bd. of Health, eff. 11-2-88)

NAC 444.320 “Bather” defined. ([NRS 439.200](#), [444.070](#)) “Bather” means any person using the spa and adjoining deck area for the purpose of therapy, water sports or related activities.

[Bd. of Health, Public Spa Reg. Art. 1, § 1.2, eff. 11-27-79]

NAC 444.330 “Deck” defined. ([NRS 439.200](#), [444.070](#)) “Deck” means the unobstructed area around the perimeter of a spa which is specifically used by bathers.

[Bd. of Health, Public Spa Reg. Art. 1 § 1.3, eff. 11-27-79]—(NAC A 11-2-88)

NAC 444.340 “Health authority” defined. ([NRS 439.200](#), [444.070](#)) “Health authority” means officers and agents of the Health Division or of the local boards of health.

[Bd. of Health, Public Spa Reg. Art. 1 § 1.4, eff. 11-27-79]

NAC 444.345 “Hydrojet” defined. ([NRS 439.200](#), [444.070](#)) “Hydrojet” means a fitting which blends air and water creating a high velocity turbulent stream of air and water.

[Bd. of Health, Public Spa Reg. Art. 1 § 1.5, eff. 11-27-79]

NAC 444.347 “Hydrojet pump system” defined. ([NRS 439.200](#), [444.070](#)) “Hydrojet pump system” means a system in which one or more hydrojets are activated by the use of a pump which is completely independent of the filtration and heating system of the spa.

[Bd. of Health, Public Spa Reg. Art. 1 § 1.6, eff. 11-27-79]

NAC 444.350 “Ladder” defined. ([NRS 439.200](#), [444.070](#)) “Ladder” means a series of vertically separated treads or rungs connected by vertical rail members or independently fastened to a vertical spa wall.

[Bd. of Health, Public Spa Reg. Art. 1 § 1.17.1, eff. 11-27-79]

NAC 444.353 “Multiport valve” defined. ([NRS 439.200](#), [444.070](#)) “Multiport valve” means a separate switching valve that has a separate position for each of the various filter operations and that combines in one unit the functions of two or more direct-flow valves.

(Added to NAC by Bd. of Health, eff. 11-2-88)

NAC 444.355 “Nonslip surface” defined. ([NRS 439.200](#), [444.070](#)) “Nonslip surface” means a surface which is designed to reduce or prevent slipping of bare feet.

[Bd. of Health, Public Spa Reg. Art. 1 § 1.7, eff. 11-27-79]

NAC 444.360 “NTU” defined. ([NRS 439.200](#), [444.070](#)) “NTU” means nephelometric turbidity units, a measure of water clarity.

[Bd. of Health, Public Spa Reg. Art. 1 § 1.8, eff. 11-27-79]

NAC 444.365 “Overflow system” defined. ([NRS 439.200](#), [444.070](#)) “Overflow system” means perimeter-type overflows, surface skimmers, and surface water collection systems of various design and manufacture.

[Bd. of Health, Public Spa Reg. Art. 1 § 1.9, eff. 11-27-79]

NAC 444.370 “Person” defined. ([NRS 439.200](#), [444.070](#)) “Person” includes governmental agencies.

[Bd. of Health, Public Spa Reg. Art. 1 § 1.10, eff. 11-27-79]

NAC 444.375 “Plastic” defined. ([NRS 439.200](#), [444.070](#)) “Plastic” means any of numerous organic, synthetic, or processed materials which are composed mostly of thermoplastic or thermosetting polymers of high molecular weight and which can be molded, cast, or extruded at some stage in manufacture or in

processing into finished articles or objects, or can be shaped by flow.

[Bd. of Health, Public Spa Reg. Art. 1 § 1.11, eff. 11-27-79]

NAC 444.380 “Prefabricated spa” defined. ([NRS 439.200](#), [444.070](#)) “Prefabricated spa” means a public spa that has been designed by a licensed professional engineer to be fabricated at a factory into a packaged unit consisting of all of the required components for a public spa, with construction on-site consisting mainly of assembling the components.

[Bd. of Health, Public Spa Reg. Art. 1 § 1.12, eff. 11-27-79]—(NAC A 1-16-96)

NAC 444.385 “Public spa” defined. ([NRS 439.200](#), [444.070](#))

1. “Public spa” means any spa operated by any person, whether owner, lessee, operator, licensee or concessionaire, for the use of the public or the membership of an organization, whether or not a fee is charged for its use.

2. The term does not include spas at single-family private residences which are controlled by the homeowner, the use of which is limited to swimming or bathing by members of the family or invited guests.

[Bd. of Health, Public Spa Reg. Art. 1 § 1.13, eff. 11-27-79]

NAC 444.390 “Ramp” defined. ([NRS 439.200](#), [444.070](#)) “Ramp” means a sloping floor, walk or roadway leading from one level to another, or leading to the spa edge and having a maximum slope of 1:12.

[Bd. of Health, Public Spa Reg. Art. 1 § 1.14, eff. 11-27-79]

NAC 444.395 “Recessed steps” defined. ([NRS 439.200](#), [444.070](#)) “Recessed steps” means a riser and tread or a series of risers and treads extending down into the deck with the bottom riser and tread ending at the spa wall, creating a stair well.

[Bd. of Health, Public Spa Reg. Art. 1 § 1.17.2, eff. 11-27-79]

NAC 444.397 “Recessed treads” defined. ([NRS 439.200](#), [444.070](#)) “Recessed treads” means a series of vertically spaced cavities in the spa wall creating tread areas for stepholes.

[Bd. of Health, Public Spa Reg. Art. 1 § 1.17.3, eff. 11-27-79]

NAC 444.398 “Remodel” defined. ([NRS 439.200](#), [444.070](#))

1. “Remodel” means to replace all or part of any structure, circulation system or appurtenance of a public bathing or swimming facility or to modify it to the extent that its design, configuration or operating characteristics differ in any respect from those of the original.

2. The term does not include normal maintenance and repair or the replacement of equipment that has previously been approved unless the result of the maintenance or repair is that the type, size or operating characteristics of the equipment are substantially different from those of the original.

(Added to NAC by Bd. of Health, eff. 11-2-88)

NAC 444.399 “Slip resistant” defined. ([NRS 439.200](#), [444.070](#)) “Slip resistant” means a finish or textured surface designed to prevent or reduce slipping by bare skin in contact with it under wet conditions.

(Added to NAC by Bd. of Health, eff. 11-2-88)

NAC 444.400 “Spa” defined. ([NRS 439.200](#), [444.070](#))

1. “Spa” means a pool primarily designed for therapeutic use which is not drained, cleaned or refilled for each user.

2. The term includes units which employ hydrojet circulation, hot water, cold water, mineral water, air induction bubbles or combinations of them.

[Bd. of Health, Public Spa Reg. Art. 1 § 1.15, eff. 11-27-79]

NAC 444.403 “Spa enclosure” defined. ([NRS 439.200](#), [444.070](#)) “Spa enclosure” means an effective barrier for excluding unauthorized persons from the spa area and the area inside of the fence or barrier

surrounding the spa.

[Bd. of Health, Public Spa Reg. Art. 1 § 1.16, eff. 11-27-79]

NAC 444.405 “Stairs” defined. ([NRS 439.200](#), [444.070](#)) “Stairs” means a riser and tread or a series of risers and treads extending down from the deck into the spa.

[Bd. of Health, Public Spa Reg. Art. 1 § 1.17.4, eff. 11-27-79]

NAC 444.407 “Steps” defined. ([NRS 439.200](#), [444.070](#)) “Steps” means stairs or ladders designed to permit entry and exit to and from the spa.

[Bd. of Health, Public Spa Reg. Art. 1 § 1.17, eff. 11-27-79]

NAC 444.410 “Toxic” defined. ([NRS 439.200](#), [444.070](#)) “Toxic” means a quality which might produce an adverse physiological effect on a person.

[Bd. of Health, Public Spa Reg. Art. 1 § 1.18, eff. 11-27-79]

NAC 444.415 “Waterline” defined. ([NRS 439.200](#), [444.070](#)) “Waterline” means:

1. Where a skimmer system is in use, the midpoint of the operating range of the skimmer.
2. Where an overflow system is in use, the height of the overflow rim.

[Bd. of Health, Public Spa Reg. Art. 1 §§ 1.19-1.19.2, eff. 11-27-79]

NAC 444.416 “Wet deck area” defined. ([NRS 439.200](#), [444.070](#)) “Wet deck area” means the 4-foot-wide unobstructed area outside a spa’s or pool’s water perimeter, curb, diving boards, diving towers or pool sides.

(Added to NAC by Bd. of Health, eff. 11-2-88)

NAC 444.417 Applicability. ([NRS 439.200](#), [444.070](#))

1. The provisions of [NAC 444.310](#) to [444.546](#), inclusive, referring to construction or modifications apply to all public spas constructed on or after November 27, 1979, and to any other public spa, where, in the opinion of the health authority, enforcement of those provisions is necessary to eliminate a condition hazardous to health or safety.

2. The provisions of [NAC 444.310](#) to [444.546](#), inclusive, pertaining to maintenance and sanitation apply to all public spas.

[Bd. of Health, Public Spa Reg. Art. 31, eff. 11-27-79]

NAC 444.419 Severability. ([NRS 439.200](#), [444.070](#)) If any provision of [NAC 444.310](#) to [444.546](#), inclusive, is declared unconstitutional or invalid for any reason, the remainder of the provisions of those sections are not intended to be affected thereby.

[Bd. of Health, Public Spa Reg. Art. 32, eff. 11-27-79]

Preliminary Requirements

NAC 444.420 Application; plans, specifications and descriptive material. ([NRS 439.200](#), [444.070](#), [444.080](#))

1. Any person who desires to construct a public spa or modify or add to an existing public spa or alter its equipment must apply in writing to the health authority on forms furnished by the health authority, giving the name of the bathing place and its location together with such other information as may be required. The application must be accompanied by plans, specifications and supporting data.

2. Plans and specifications for spas which are not prefabricated must have been prepared by a professional engineer who is registered in this State, an architect who is registered in this State, or a licensed contractor who holds a classification A license with an A-10 subclassification issued by the State Contractors’ Board. A licensed professional engineer or a registered architect shall include his or her seal and signature on any plans and specifications submitted to the health authority. A licensed contractor shall

include his or her signature on any plans and specifications submitted to the health authority.

3. The plans must be drawn to scale, include a north arrow, and be accompanied by proper specifications to permit a comprehensive engineering review. The plans must include:

- (a) A plot plan and sectional views with all necessary dimensions of the spa and surrounding area.
- (b) A piping diagram showing all plumbing, including treatment facilities with pertinent elevation data, in sufficient detail to permit a hydraulic analysis of the system.
- (c) An electrical diagram showing the method of grounding and other pertinent details, which must show lighting and other electrical systems.
- (d) Detailed plans of the bathhouse, equipment rooms, dressing rooms, toilet facilities, showers, and other spa structures and facilities.
- (e) A hydraulic analysis completed by the applicant or his or her representative and submitted to the health authority on a form provided by the health authority.

4. Leaflets, catalogs or other descriptive material must be furnished when mechanical equipment is specified by trade name, catalog number or any other designation which identifies the equipment, rather than by specification. This material will be returned to the applicant upon his or her request after the review of the plans has been completed.

5. The plans must be complete. The plans and specifications must be submitted in triplicate or as otherwise required.

6. The submitted plans must be approved in writing before any construction is undertaken.

[Bd. of Health, Public Spa Reg. Art. 2 §§ 2.1-2.1.5.6, eff. 11-27-79]—(NAC A 1-16-96)

NAC 444.422 Changes in plans; review of plans; structural adequacy. ([NRS 439.200](#), [444.070](#), [444.080](#))

1. Public spa facilities must be built in accordance with the plans as approved, unless prior approval of any changes is obtained in writing from the health authority.

2. The review of the plans by the health authority will not include review of structural design or structural stability of any part of a public spa. Certification of structural adequacy is the responsibility of the design engineer, architect, licensed contractor or the manufacturer.

3. The health authority shall review the plans within 30 days after receiving them.

[Bd. of Health, Public Spa Reg. Art. 2 §§ 2.2-2.3, eff. 11-27-79]

NAC 444.424 Inspections. ([NRS 439.200](#), [444.070](#), [444.090](#))

1. The owner, or his or her agent, shall notify the health authority at specific predetermined stages of construction and at the time of completion of the public spa to permit inspection of the public spa and related equipment during and after construction.

2. In areas of the State where the health authority cannot provide the inspection and where local government does not require building inspections, the owner or his or her agent may be required to hire an independent inspector. The independent inspector may be selected by the owner or his or her agent upon the approval of the health authority.

3. No public spa may be placed in operation until such inspections show compliance with the requirements of [NAC 444.310](#) to [444.512](#), inclusive.

[Bd. of Health, Public Spa Reg. Art. 2 §§ 2.4-2.4.3, eff. 11-27-79]

Construction of Spa

NAC 444.428 Adoption of Standards by reference. ([NRS 439.200](#), [444.070](#)) The State Board of Health adopts by reference NSF International Standards 14, "Plastic Piping Components and Related Materials," 50, "Circulation System Components for Swimming Pools, Spas/Hot Tubs" and 61, "Drinking Water System Components-Health Effects." A copy of the Standards may be purchased from the NSF International, P.O. Box 130140, Ann Arbor, Michigan 48113. The cost of Standard 14 is \$40. The cost of Standard 50 is \$45. The cost of Standard 61 is \$65.

(Added to NAC by Bd. of Health, eff. 11-2-88; A 1-16-96)

NAC 444.429 Use of equipment and materials not approved by NSF International. ([NRS 439.200, 444.070](#)) The health authority may permit the use of equipment and materials which are not designated by the NSF International as complying with the Standards adopted pursuant to [NAC 444.428](#) if the health authority determines that the equipment and materials comply with standards equivalent to the NSF International Standards.

(Added to NAC by Bd. of Health, eff. 1-16-96)

NAC 444.430 Shape. ([NRS 439.200, 444.070](#)) The shape of any public spa must be such that the circulation of the water will not be impaired.

[Bd. of Health, Public Spa Reg. Art. 11 § 11.1, eff. 11-27-79]

NAC 444.432 Depth. ([NRS 439.200, 444.070](#))

1. The maximum water depth for a public spa is 4 feet (1.22 m), measured from the waterline. Exceptions may be made by the health authority for spas designed for special purposes such as instruction, treatment and therapy.

2. The maximum depth for any seat or sitting bench in a public spa is 2 feet (61 cm) measured from the waterline.

[Bd. of Health, Public Spa Reg. Art. 11 §§ 11.2 & 11.3, eff. 11-27-79]

NAC 444.434 Depth markings. ([NRS 439.200, 444.070](#)) Spas must have permanent depth markings plainly and conspicuously posted and located as follows:

1. The maximum water depth must be clearly marked.
2. Depth markings must be positioned within 18 inches (46 cm) of the water's edge.
3. Depth markings must be positioned to be read while standing on the deck facing the water.
4. There must be at least two depth markings per spa regardless of spa size or shape.

[Bd. of Health, Public Spa Reg. Art. 28 §§ 28.2-28.2.4, eff. 11-27-79]

NAC 444.436 Slope. ([NRS 439.200, 444.070](#)) The slope of the spa floor must not exceed 1 foot (30.50 cm) of fall in 12 feet (3.66 m).

[Bd. of Health, Public Spa Reg. Art. 11 § 11.5, eff. 11-27-79]

NAC 444.438 Materials. ([NRS 439.200, 444.070](#))

1. Materials used in components and accessories used in and around public spas must not be hazardous to humans or to the environment in which the spa is installed. These materials must be capable of fulfilling the requirements of design, installation and intended use.

2. All materials and accessories to be used in and around public spas must be selected to ensure that all parts with external surfaces and edges which might come in contact with a bather are assembled, arranged and finished so that they will not constitute a hazard to the health or safety of children or adults who are using the spa for its intended purpose.

3. Wood may not be used as a material, component or accessory in public spas.

[Bd. of Health, Public Spa Reg. Art. 7, eff. 11-27-79]—(NAC A 11-2-88)

NAC 444.440 Structural design. ([NRS 439.200, 444.070](#))

1. The structural design and materials used in constructing a public spa must meet generally accepted structural engineering practice and provide a sound, durable structure which will safely sustain all the dead loads, live loads, liquid, hydrostatic and earth pressures involved. The spa must be watertight and the surfaces must be inert, nontoxic, smooth and easily cleaned, and should be light in color.

2. The strength of the assembled or installed components and accessories used in and around a public spa must be such that no structural failure of any component part can cause the failure of any other part.

[Bd. of Health, Public Spa Reg. Art. 8 §§ 8.1 & 8.2, eff. 11-27-79]

NAC 444.442 Steps, ladders, treads and handrails required. ([NRS 439.200, 444.070](#))

1. Spa steps, ladders or recessed treads must be provided when the spa is more than 2 feet (61 cm) deep.
2. A spa must be equipped with at least one handrail (or ladder equivalent) for each 50 feet (15.25 m) of perimeter or portion thereof, to designate the point or points of entry and exit.
[Bd. of Health, Public Spa Reg. Art. 12 §§ 12.1 & 12.2, eff. 11-27-79]

NAC 444.444 Spa steps and recessed steps. ([NRS 439.200](#), [444.070](#)) Where required, spa steps and recessed steps must meet the following specifications:

1. Step treads must have a minimum unobstructed horizontal tread depth of 10 inches (25.40 cm) and a minimum width of 12 inches (30.48 cm). Step treads must have slip-resistant surfaces.
2. Step risers must not be less than 7 inches (17.78 cm) high nor more than 1 foot (30.48 cm) high. When the bottom tread serves as a bench or seat, the bottom riser must be no more than 1 foot 2 inches (35.56 cm) high. The first and last risers need not be uniform in height, but must comply with the requirements of this subsection. The height of the top riser must be measured from the finished deck. Risers between the first and last risers must be uniform in height.
3. The horizontal edge of a step, seat or bench tread must be constructed of a material which contrasts with the color of the steps, and must be clearly visible and evident to bathers. The contrasting material on the horizontal edge must be at least 2 inches (5 cm) wide.
4. The outside edge of handrails placed to assist bathers to leave the spa must be located not more than 1 foot 9 inches (53.34 cm) or less than 1 foot 3 inches (38.10 cm) from a line drawn vertically from the bottom riser, away from the spa wall.
5. Seats or benches may be provided as part of the steps.
[Bd. of Health, Public Spa Reg. Art. 12 §§ 12.3 & 12.3.1-12.3.9, eff. 11-27-79]—(NAC A 11-2-88)

NAC 444.446 Recessed treads. ([NRS 439.200](#), [444.070](#)) Recessed treads, when provided, must meet the following specifications:

1. Stepholes must be:
 - (a) Uniformly spaced, not more than 1 foot (30.48 cm) nor less than 7 inches (17.48 cm) apart at the centerline.
 - (b) At least 5 inches (12.70 cm) deep and at least 1 foot (30.48 cm) wide.
2. Step hole treads must be sloped to drain into the spa to prevent accumulation of dirt.
3. The vertical distance between the spa coping edge and the uppermost recessed tread must be 1 foot (30.48 cm) or less.
4. Each set of recessed treads must be provided with two handrails which fully serve all treads and risers.
[Bd. of Health, Public Spa Reg. Art. 12 §§ 12.5-12.5.5, eff. 11-27-79]

NAC 444.448 Ladders. ([NRS 439.200](#), [444.070](#)) Where required, ladders must meet the following specifications:

1. Spa ladders must be made entirely of corrosion-resistant materials.
2. Ladder treads must have slip-resistant surfaces.
3. Ladder designs must provide two handholds or handrails which fully serve all treads. The outside diameter of handrails must not be more than 1.9 inches (4.83 cm) or less than 1 inch (2.54 cm).
4. The clearance between a ladder and the spa wall must be not more than 6 inches (15.24 cm) nor less than 3 inches (7.62 cm).
[Bd. of Health, Public Spa Reg. Art. 12 §§ 12.4-12.4.5, eff. 11-27-79]

NAC 444.450 Handholds. ([NRS 439.200](#), [444.070](#))

1. A public spa must be provided with suitable handholds around the perimeter in areas where the spa is more than 3 feet 6 inches (1.07 m) deep, measured from the deepest point of the spa floor to the waterline.
2. Handholds must be spaced no farther apart than 4 feet (1.22 m) and must be provided with a suitable, slip-resistant surface.
3. Handholds may be:
 - (a) Ledges, radiused flanges, or cantilevered decks along the immediate top edge of the spa, located not

more than 1 foot (30.50 cm) above the waterline.

- (b) A rope or railing placed not more than 1 foot (30.50 cm) above the waterline, fastened to the spa wall.
- (c) Ladders, steps and seat ledges.
- (d) A combination of the handholds listed in this section.

4. The overhang for coping or cantilevered decking:

(a) Must not exceed 2 inches (5.08 centimeters) or be less than 1 inch (2.54 centimeters).

(b) Must not exceed 2 1/2 inches (6.4 centimeters) in thickness for a spa for which an operating permit has been issued before January 16, 1996.

(c) Must not exceed 3 1/2 inches (8.89 centimeters) in thickness for a spa for which an operating permit is issued on or after January 16, 1996.

[Bd. of Health, Public Spa Reg. Art. 11 §§ 11.4-11.4.4, eff. 11-27-79]—(NAC A 11-2-88; 1-16-96)

NAC 444.452 Miscellaneous requirements. ([NRS 439.200](#), [444.070](#))

1. The surface finish of all public spas, including the bottom and sides, should be light-colored material and must present a smooth surface which can be easily cleaned and which has no cracks, openings, seams or expansion joints.

2. The finished trim dimension tolerances for prefabricated units must be the manufacturer's stated "rough-in" dimensions $\pm 1/2$ inch (± 1.27 cm).

3. Each prefabricated spa must be supplied by the manufacturer with a copy of the manufacturer's written installation instructions affixed to the spa in a conspicuous place.

4. Each prefabricated spa must be supplied with a copy of the manufacturer's written care and maintenance instructions affixed to the unit in a conspicuous place.

5. The manufacturer's name, trademark, or both, must be permanently and legibly marked on each prefabricated spa so that it is visible after installation.

[Bd. of Health, Public Spa Reg. Art. 6, eff. 11-27-79]

NAC 444.454 Decks: Dimensional design. ([NRS 439.200](#), [444.070](#))

1. A continuous unobstructed deck at least 4 feet (1.22 m) wide, including the coping, must be provided around at least half of the perimeter of the spa. Deck and wall junctures must be coved with a minimum of 4 inches (10.16 cm). Decks elevated above the normal walking level of the area must have protective safety barriers at the edge as required by [NAC 444.463](#).

2. Risers of steps for the deck must be uniform and be not less than 3.75 inches (9.53 cm) nor more than 7.75 inches (19.70 cm) high. The minimum tread width is 10 inches (25.40 cm).

3. The maximum slope of decks is .5 inch per foot (4.0 cm per meter) except for ramps. Ramps may have a slope of not more than 5 percent.

4. The maximum voids between adjoining concrete slabs or between concrete slabs and expansion joint material is .2 inch (.51 cm) of horizontal clearance, with a maximum difference in elevation of .25 inch (.64 cm).

5. Joints where spa coping meets concrete deck work must be watertight and must not allow water to seep to the ground beneath. Joints in decks must be provided to prevent cracks which may be hazardous because of differences in elevations, separation of surfaces or movement of the deck.

6. Areas where deck work joins concrete work other than the spa must be protected by expansion joints filled with nonrigid material such as mastic to protect the spa from the pressures of relative movements. In the absence of specific local engineering practices, the work must be performed in accordance with recommended practices of the American Concrete Institute.

7. Where deck work joins the spa coping, the joining areas must be designed and installed to protect adequately the spa coping and its mortar bed from damage as a result of reasonable movement of adjoining deck work.

8. Decks must be edged, radiused or otherwise relieved so as to present no exposed sharp corners.

9. Decks must be sloped as required by subsection 3 to drain to perimeter areas or to deck drains. Deck drains must not be greater than 25 feet (7.62 m) apart and must not return water to the recirculation system. Drains must remove spa splash water, deck cleaning water, and rainwater at a rate approximately equal to the rate of arrival without leaving excessive puddles.

10. Deck work must be designed and installed in accordance with engineering practices required in the area of installation. This includes, but is not limited to, the design and quality of the subbase when required, concrete mix design, and reinforcing. In the absence of specific local engineering practices, the work must be performed in accordance with recommended practices of the American Concrete Institute.

[Bd. of Health, Public Spa Reg. Art. 13 §§ 13.4 & 13.7-13.16, eff. 11-27-79]—(NAC A 11-2-88)

NAC 444.456 Decks: Surfaces. ([NRS 439.200](#), [444.070](#))

1. Decks, ramps and similar surfaces, including step treads, must be reserved for the use of bathers only, and be slip resistant.
2. Roughness or irregularity of slip-resistant surfaces must not cause injury or discomfort under intended use.
3. Special features in or on decks, such as depth markings, pool brand insignia or similar markings, must conform to the requirements of [NAC 444.454](#) to [444.460](#), inclusive.
4. The ground on which any spa structure rests must be adequately compacted to support properly the structure.
5. Synthetic deck surfaces must be designed to be slip resistant and comply with requirements set forth by the health authority.
6. Wood decks, carpets and other absorbent materials are prohibited in the wet deck area.

[Bd. of Health, Public Spa Reg. Art. 13 §§ 13.1-13.3, 13.5 & 13.6, eff. 11-27-79]—(NAC A 11-2-88)

NAC 444.458 Hose bibs. ([NRS 439.200](#), [444.070](#)) One or more hose bibs must be provided within 50 feet (15.24 m) of the facility for use in cleaning the deck area and above, and they must be located so that they do not constitute a safety hazard.

[Bd. of Health, Public Spa Reg. Art. 13 § 13.17, eff. 11-27-79]

NAC 444.460 Drinking fountains. ([NRS 439.200](#), [444.070](#)) A drinking fountain must be provided within 100 feet (30.48 m) of the spa where it will be readily accessible from a spa pool. The drinking fountain may be inside or outside the spa pool enclosure.

[Bd. of Health, Public Spa Reg. Art. 13 § 13.18, eff. 11-27-79]

NAC 444.462 Roofs and canopies. ([NRS 439.200](#), [444.070](#)) Roofs and canopies over public spas must be constructed so that moisture or condensation from the roof or canopy does not drain into the spa. Roofs and canopies must be constructed so that they blend in with the surroundings and must be acoustically treated.

[Bd. of Health, Public Spa Reg. Art. 8 §§ 8.3 & 8.3.1, eff. 11-27-79]

NAC 444.463 Enclosures; exclusion of unauthorized persons. ([NRS 439.200](#), [444.070](#)) The holder of a permit to operate a public spa must:

1. Establish procedures to exclude unauthorized persons from the spa and spa area.
2. Construct a fence, wall, building, enclosure or any combination thereof which completely encloses the spa or pool area and:
 - (a) Is constructed from materials which:
 - (1) Offer no external handholds or footholds.
 - (2) Are impenetrable by small children.
 - (b) Has a height of at least 5 feet (1.52 meters) if the facility is operated solely for and in conjunction with lodgings, or a height of at least 6 feet (1.8 meter) if the facility is open to the general public and not operated solely for and in conjunction with lodgings.
 - (c) Has vertical supports spaced no wider than 4 inches (10.16 cm) apart.
 - (d) If an opening is provided under the bottom of the enclosure, has an opening no wider than 4 inches (10.16 cm).
 - (e) Contains gates and doors equipped with permanent locking devices and self-closing and positive self-latching closure mechanisms at least 3 1/2 feet (1.06 meters) above the deck, walkway or floor and opening

into the spa or pool area so that the gates and doors close by themselves and positively latch from any open position.

Facilities which have 24-hour-a-day security for the spa or pool area may be exempted from the requirements of this section.

(Added to NAC by Bd. of Health, eff. 11-2-88)

NAC 444.465 Gates and doors. ([NRS 439.200](#), [444.070](#)) Gates and doors which open into a spa or pool area must not be blocked open. The self-closing mechanisms or latches on the gates and doors may not be altered so that the gates and doors remain open.

(Added to NAC by Bd. of Health, eff. 11-2-88)

NAC 444.466 Electrical requirements. ([NRS 439.200](#), [444.070](#))

1. Wiring and grounding of all electrical equipment associated with a spa and the bonding and grounding of all metal parts must meet the *National Electric Code* published by the National Fire Protection Association.

2. Area lighting must not be installed directly over the spa water surface. Area lights must be shielded.

3. Underwater lighting may be installed on the bottom step or bench riser only.

4. All equipment, fixtures and wiring must bear an appropriate Underwriters Laboratories, Inc., label or the equivalent.

[Bd. of Health, Public Spa Reg. Art. 10, eff. 11-27-79]—(NAC A 11-2-88)

NAC 444.468 When bathhouses required. ([NRS 439.200](#), [444.070](#))

1. Dressing rooms, toilet facilities and shower rooms are required for all public spas other than those provided in connection with lodging facilities if the spa is reserved for tenants or guests who occupy the lodging facilities. "In connection with lodging facilities" means that the spa is so situated that no bather will have to walk more than 300 feet (91.44 m) to sanitary facilities.

2. Where no bathhouse is located within 300 feet (91.44 m) of the spa, there must be a flush toilet, a lavatory and a shower for men, and the same facilities for women, at the spa.

[Bd. of Health, Public Spa Reg. Art. 14 §§ 14.1-14.3, eff. 11-27-79]

NAC 444.470 Bathhouse facilities. ([NRS 439.200](#), [444.070](#))

1. The entrance and exits of a bathhouse must be screened to break any line of sight from outside.

2. Each bathhouse must be provided with separate facilities for each sex with no interconnection between the provisions for male and female bathers.

3. Floor surfaces must be reasonably smooth and slope at a rate of .25 inch per foot (2 cm per meter) toward the floor drains. Walls and partitions must be reasonably smooth and be made of durable material. A space of 10 inches to 12 inches (25.40 to 30.48 cm) must be left between the floor and the bottom of partitions forming compartments within dressing, shower and toilet rooms.

4. Each bathhouse must be arranged so that patrons, on leaving the dressing rooms, must pass the toilets and go through the showers to get to the spa.

5. Showers must be supplied with water at a temperature of at least 90°F (32.22°C) at a rate of 3 gallons per minute (11.34 liters per minute) per shower head. Mixing valves must be installed to prevent scalding of bathers.

6. Each licensee shall provide:

(a) One water closet for each 75 male bathers or fraction thereof, and one for each 50 female bathers or fraction thereof.

(b) One urinal for each 75 male bathers or fraction thereof.

(c) One lavatory for each 100 male bathers and one for each 100 female bathers, or fractions.

(d) One shower for each 50 male bathers and one for each 50 female bathers, or fractions.

7. Lockers, if provided, must be properly vented and set on solid masonry bases at least 4 inches high (10.16 cm) or on legs at least 10 inches (25.40 cm) long.

[Bd. of Health, Public Spa Reg. Art. 14 §§ 14.4-14.11, eff. 11-27-79]

NAC 444.472 Ventilation. ([NRS 439.200](#), [444.070](#))

1. Indoor spas, shower rooms, dressing rooms and toilets of public spas must be properly ventilated.
2. Ventilation systems for indoor spas must be designed to prevent direct drafts on the bathers.
3. There must be at least five air changes per hour in the area in which an indoor spa is located, including spas located adjacent to enclosed swimming pools.
4. All interior rooms must be ventilated to the outside and in such a way that they do not remain excessively damp.

[Bd. of Health, Public Spa Reg. Art. 9, eff. 11-27-79]

NAC 444.474 Supply of water. ([NRS 439.200](#), [444.070](#))

1. The water supply of the spa must be from an approved source and meet the requirements of the Health Division for potable water, except that the health authority may approve the use of natural hot or mineral waters.
2. A fillspout, if used, must have an air gap of not less than twice the pipe diameter, or 3 inches (7.62 cm) above the overflow of the spa, whichever is greater, and the fillspout must not protrude more than 2 inches (5.08 cm) beyond the edge of the spa.
3. The fillspout, if used, must be properly shielded so as not to create a hazard.
4. A surge tank or receptor may be installed for filling the spa if the spa water will freely overflow at deck level, the top of the surge tank or the top of the receptor before coming in contact with the water supply outlet.

[Bd. of Health, Public Spa Reg. Art. 17 §§ 17.1-17.3, eff. 11-27-79]—(NAC A 11-2-88)

NAC 444.476 Quality of water. ([NRS 439.200](#), [444.070](#)) The spa equipment must provide water meeting the following standards:

1. The water must be continuously disinfected by a chemical which imparts an easily measured, freely available residual effect. Adequate disinfection may be accomplished by:
 - (a) Normal chlorination 1.0 to 5.00 ppm (1.0 to 5.0 mg/l) of free chlorine at pH 7.0 to 8.0.
 - (b) Chlorinated cyanurate chlorination 1.0 to 5.00 ppm (1.0 to 5.0 mg/l) at pH 7.2 to 8.0.
 - (c) Normal bromination 3.0 to 5.0 ppm (3.0 to 5.0 mg/l) at pH 7.0 to 8.0.
2. The health authority may accept another disinfecting material or method when it has been adequately demonstrated to the health authority that it provides a satisfactory residual effect which is easily measured, and that it is otherwise as effective under conditions of use as the chlorine concentration required in this section.
3. The maximum permissible concentration of cyanuric acid is 100 ppm (100 mg/l).
4. The total alkalinity should be within the range of 80 to 120 ppm (80 to 120 mg/l), but alkalinity must not exceed 150 ppm (150 mg/l).
5. The chemical quality of water in the spa must not cause objectionable physiological effects to bathers.

[Bd. of Health, Public Spa Reg. Art. 17 §§ 17.4-17.4.4, eff. 11-27-79]—(NAC A 11-2-88)

NAC 444.477 Inlets. ([NRS 439.200](#), [444.070](#))

1. Spa inlets must be:
 - (a) Rounded.
 - (b) Smooth.
 - (c) Installed at least 18 inches (46 centimeters) below the normal operating water level. An exception to this requirement may be granted by the health authority if the shallow depth of the pool or spa prevents the inlets from being installed at that depth.
 - (d) Located to produce a uniform circulation, without the existence of dead spots.
2. Spa inlets must not extend from the pool wall or floor.
3. Each set of stairs must have an inlet positioned to provide good circulation over the stairs.
4. If wall inlets are used, the spacing between adjacent inlets must not exceed 15 feet. The spacing may be varied if the number of inlets is not reduced below a number equal to one-fifteenth of the pool's perimeter in feet.
5. Any spa having a width greater than 30 feet (9 meters) must have floor inlets located to provide

general circulation and not direct flow to floor drains. If floor inlets are used, the spacing between adjacent inlets must not exceed 15 feet and the spacing between inlets and the adjacent wall must not exceed 10 feet (3.04 meters).

6. A combination of wall and floor inlets may be used if the design can be shown to produce a uniform circulation of water to maintain a uniform residual of disinfectant throughout the spa.

7. Spas greater than 30 feet (9.14 meters) in width must have floor inlets which comply with the spacing requirements of subsection 5 or with a combination of wall and floor inlets which comply with the spacing requirements of subsections 4 and 5.

(Added to NAC by Bd. of Health, eff. 11-2-88)

NAC 444.480 Drains. ([NRS 439.200](#), [444.070](#))

1. Each spa must be provided with a drain at the deepest point to permit complete drainage. Outlets on the pump suction must be covered by suitable protective grates or antivortex covers which are securely fastened and cannot be removed except with tools.

2. The total velocity through grate openings must not exceed 1 1/2 feet per second (.5 meters per second) through an opening no greater than 1/2 square inch (1.3 square centimeters). Where only one main drain is provided, it must be an antivortex drain and velocity must not exceed 6 feet per second.

3. The location and design of spa outlets must incorporate at least one of the following methods for preventing outlet entrapment:

(a) The spa must contain at least two outlets separated by a minimum of 3 feet, or located on different surface planes within the spa.

(b) A hydrojet booster system that includes no fewer than two main drains separated by not less than 4 feet and connected to pipes of equal diameter. The system must not permit either drain to be cut off from the suction line. Drains for hydrojet booster systems must have antivortex covers as approved by the health authority.

(c) The spa's drainage system must include at least one antivortex outlet drain. In depths of 4 feet 6 inches (1.37 meters) or less the antivortex drain must not provide a tripping or stubbing hazard to the bather.

(d) The spa's drainage system must contain some other approved means to guard against outlet entrapment.

4. The main drains must be capable of taking at least 50 percent of the circulated flow.

[Bd. of Health, Public Spa Reg. Art. 18 §§ 18.3-18.5, eff. 11-27-79]—(NAC A 11-2-88)

NAC 444.482 Piping. ([NRS 439.200](#), [444.070](#))

1. Piping must be made of nontoxic material, resistant to corrosion and able to withstand operating pressures. Pipes must be identified by color code, tags or labels. All plastic piping and fittings used in the recirculation system must be designated by the NSF International as complying with all applicable requirements of NSF International Standard 14 or Standard 61 for potable water applications or in the absence of applicable requirements, be approved by the health authority. The piping must be imprinted with the manufacturer's name and the potable water mark of the NSF International, "NSF-pw," the make that indicates compliance with Standard 61, "NSF-61," or an equivalent mark.

2. The water velocity in spa piping other than copper piping must not exceed 10 feet per second (3.05 meters per second) for discharge piping. The velocity for copper piping must not exceed 6 feet per second (1.83 meters per second). Suction velocity for all piping must not exceed 6 feet per second (1.83 meters per second).

3. Piping around the spa which is subject to damage by freezing must be sloped for adequate drainage and supported at sufficiently close intervals so that sagging between supports will not trap water. Provisions must be made for expansion and contraction of pipes.

[Bd. of Health, Public Spa Reg. Art. 18 §§ 18.6-18.8, eff. 11-27-79]—(NAC A 11-2-88; 1-16-96)

NAC 444.484 Circulation and filtration. ([NRS 439.200](#), [444.070](#)) Public spas must be equipped with circulation and filtration equipment which meets the following criteria:

1. Circulation and filtration equipment must be of sufficient capacity to recirculate the entire spa water capacity at least once every 30 minutes, and must be capable of returning the spa water to a turbidity of 1.0

NTU's at least once during the 4 hours following the use of the spa by the largest number of bathers which its size permits.

2. Equipment must be provided with installation and operation instructions by those who furnish the equipment.

3. A pressure gauge with an appropriate range must be provided in connection with each filter.

4. A rate-of-flow indicator must be installed according to the manufacturer's instructions.

5. Materials used in the circulation system must comply with the applicable requirements of National Sanitation Foundation Standards 14 and 50 or, in the absence of any applicable or current standards, be approved by the health authority.

6. In climates in which freezing temperatures can be expected, the spa shell and appurtenances, piping, filter system, pump and motor, and other components must be designed and constructed to be protected from damage from freezing.

7. A spa which does not have a water recirculation system for purification may be used by only one person, after which the spa must be drained and the walls scrubbed and disinfected.

8. A vacuum gauge must be located on or just before the circulation pump on the suction side and a pressure gauge must be located immediately after the pump on the pressure side.

9. The recirculation system must be operated at all times the facility is open for use and for not less than 3 hours after the facility is closed. If the system is shut down for periodic maintenance and repair, no person who is not an employee of the facility may be allowed into the facility.

10. If time clocks are used to govern the operation of the recirculation system, they must be:

(a) Used to govern the operation of any equipment, such as chemical disinfectant feeders, slurry feeders or heaters, dependent upon the flow of water within the system.

(b) Reset immediately after any interruption in power.

[Bd. of Health, Public Spa Reg. Art. 19, eff. 11-27-79]—(NAC A 11-2-88)

NAC 444.486 Pumps. ([NRS 439.200](#), [444.070](#))

1. A pump and motor must be provided for circulation of the spa water. All pumps must provide the conditions of flow required for filtering and cleaning the filters against the total dynamic head developed by the complete system.

2. With all pressure filter systems, a suitable removable strainer or screen must be provided before circulation pumps to remove debris, hair, lint and other solids. Water entering the pump must first pass through the screen.

3. Pumps must be designed to perform the functions for which they are intended. Units must be accessible for inspection and service. Replacement parts must fit with existing parts in the pump without the need for redrilling mounting holes or otherwise altering the replacement part of the pump.

4. The pump and component parts must be designed and constructed to operate safely.

5. Proper direction of rotation for the pump must be clearly indicated by an arrow on the pump data plate, on a separate plate attached to the pump, or cast into the pump itself.

6. Pumps used on spas must be designated by the NSF International as complying with all applicable requirements of NSF International Standard 50 or, in the absence of applicable requirements, be approved by the health authority.

7. Hydrotherapy pumps and piping systems must be independent and must not be interconnected with the filtration plumbing system.

[Bd. of Health, Public Spa Reg. Art. 22 §§ 22.1-22.5, 22.10 & 22.11, eff. 11-27-79]—(NAC A 11-2-88; 1-16-96)

NAC 444.488 Pump motors. ([NRS 439.200](#), [444.070](#))

1. All motors must have as a minimum an open drip-proof enclosure, as defined by National Electrical Manufacturers' Association standards, and be constructed electrically and mechanically so they will perform satisfactorily and safely under the conditions of load and environment normally encountered in spa installations.

2. Motors must be capable of operating pumps under full load, and must have as a minimum a 1.15 service factor. If the maximum service factor of the motor is exceeded at full voltage, the manufacturer shall

indicate this on the pump curve.

3. All motors must have thermal overload protection and locked rotor protection, or equivalent, built in or in the line starter, to provide locked rotor and running protection.

4. The motor frame must include adequate provisions for proper grounding.
[Bd. of Health, Public Spa Reg. Art. 22 §§ 22.6-22.9, eff. 11-27-79]

NAC 444.490 Valves. (NRS 439.200, 444.070)

1. When a pump is installed below the overflow rim of the spa, valves must be installed on permanently connected suction and discharge lines and located in an accessible place outside the walls of the spa.

2. All valves must be located where they will be readily and easily accessible for maintenance and removal.

3. Multiport valves must be designated by the NSF International as complying with all applicable requirements of NSF International Standard 50 or, in the absence of applicable requirements, be approved by the health authority.

[Bd. of Health, Public Spa Reg. Art. 23, eff. 11-27-79]—(NAC A 11-2-88; 1-16-96)

NAC 444.492 Overflow systems. (NRS 439.200, 444.070)

1. An overflow system must be provided unless the spa does not have a water recirculation system and the procedures required by subsection 7 of [NAC 444.484](#) are used.

2. The overflow system must be designed and constructed so that the water level of the spa is maintained at the operating level of the rim or weir device.

[Bd. of Health, Public Spa Reg. Art. 20 §§ 20.1 & 20.2, eff. 11-27-79]

NAC 444.494 Skimmers. (NRS 439.200, 444.070)

1. When surface skimmers are used as the sole overflow system, at least one surface skimmer must be provided for each 100 square feet (9.03 square meters), or fraction thereof, of the surface area of the water. When two or more skimmers are used in a spa, they must be located to maintain effective skimming action over the entire surface area of the water.

2. The total capacity of all skimmers must be at least two-thirds of the required recirculation flow.

3. In outdoor spas, one skimmer must be placed at a point away from the direction from which prevailing winds blow, if the surface area of the water is greater than 100 square feet (9.03 square meters).

4. Skimmers must comply with all applicable requirements of NSF International Standard 50 or, in the absence of any current or applicable standards, be approved by the health authority.

5. All skimming devices must be equipped with an approved equalizer valve and equalizer line with an inside diameter of at least 2 inches (5.08 centimeters) installed at least 12 inches (30.48 centimeters) below the normal operating level of the water. The inlet to the equalizer line or lines must be designed to prevent the creation of a holding force whenever the body or limb of a bather comes into direct contact with the inlet. The inlet must be protected by a grill or shroud that will prevent a bather or any limb of a bather from entering the inlet.

[Bd. of Health, Public Spa Reg. Art. 20 §§ 20.3-20.5, eff. 11-27-79]—(NAC A 11-2-88; 1-16-96)

NAC 444.496 Filters. (NRS 439.200, 444.070)

1. Filters must be designed to maintain spa water under anticipated operating conditions in accordance with [NAC 444.484](#).

2. Filters must be designed so that filtration surfaces can be easily restored to design capacity, inspected and serviced.

3. Separate filter, recirculation and chlorination systems must be provided for each spa and must be independent of any adjacent swimming pool or spa.

4. A means must be provided to permit release of air which enters the filter tank. This may be automatic, manual, or, when upflow design is used, air must be expelled through the filter tank. Any filters incorporating an automatic internal air release as the principal means of air release must have lids which provide a slow and safe release of pressure as a part of its design. Any separation tank used in conjunction with a filter tank must have, as part of its design, a manual means of air release or a lid which provides a slow and safe release of

pressure as it is opened. Each separation tank must have a cautionary statement warning the user not to start up the filter pump without first opening the air release. The statement must be visible and noticeable within the area of the air release.

5. Piping furnished with the filter must be of suitable material capable of withstanding three times the working pressure. The suction piping must not collapse when there is a complete shutoff of flow on the suction side of the pump.

6. Filter components which require servicing must be accessible and available for inspection and repair when installed according to the manufacturer's instructions.

7. All filters must meet the applicable standards adopted by the National Sanitation Foundation.

8. When the filter is regenerated by backwashing, provisions must be made to dispose of the backwash water in a sanitary manner and without undue labor.

[Bd. of Health, Public Spa Reg. Art. 21, eff. 11-27-79]

NAC 444.498 Disposal of wastewater. ([NRS 439.200](#), [444.070](#))

1. Provisions must be made for disposing of material cleaned from filters and of backwash water in a manner which will not create a nuisance. The backwash water must be disposed of in accordance with applicable local law and regulation.

2. When drainage to a sanitary sewer or storm sewer is permitted, an air gap must be provided which will prevent any surge or backflow of contaminated water into the spa or the recirculation system.

3. Disposal of diatomaceous earth must be made so that no solids appear in the wastewater. This may be done by using a separation tank, stand trap, or any other method approved by the health authority.

[Bd. of Health, Public Spa Reg. Art. 26, eff. 11-27-79]

NAC 444.500 Air induction systems. ([NRS 439.200](#), [444.070](#)) An air induction system must totally prevent water backup which could cause electrical shock hazards.

[Bd. of Health, Public Spa Reg. Art. 24, eff. 11-27-79]

NAC 444.502 Disinfectant required. ([NRS 439.200](#), [444.070](#)) A means for disinfecting the spa water which provides a residual of disinfectant in the spa water must be employed. Chlorine or chlorine compounds are most frequently used for the purpose of disinfecting but another bactericidal agent may be accepted if it is registered with the United States Environmental Protection Agency and the Nevada State Department of Agriculture.

[Bd. of Health, Public Spa Reg. Art. 25 § 25.1, eff. 11-27-79]

NAC 444.504 Disinfectants: Approved chemical feeders. ([NRS 439.200](#), [444.070](#)) The spa must be equipped with a chlorinator, hypochlorinator or other disinfectant feeder or feeders which meet the following standards:

1. All chemical feeding equipment and process equipment, except for feeding equipment for chlorine gas, must be designated by the NSF International as complying with all applicable requirements of NSF International Standard 50 or, in the absence of applicable requirements, be approved by the health authority.

2. Chemical feeding equipment must be capable of supplying at least the equivalent of 3 pounds (1.4 kilograms) of chlorine per 24 hours per 10,000 gallons (37,850 liters) of spa capacity for outdoor spas, and the equivalent of 1 pound (454 grams) of chlorine per 24 hours per 10,000 gallons (37,850 liters) of spa capacity for indoor spas.

3. Other disinfectant feeders may be approved if it can be demonstrated to the health authority that the required disinfectant residuals can be maintained. The material used must be subject to a simple testing procedure which will permit a ready means of determining the residual disinfectant in the water at the site of the spa.

4. Disinfectant feeders must be installed to ensure that the flow of the chemical disinfectant will stop immediately if there is an interruption in the flow of water to the pool or through the disinfection system.

[Bd. of Health, Public Spa Reg. Art. 25, §§ 25.2-25.2.2, eff. 11-27-79]—(NAC A 11-2-88; 1-16-96)

NAC 444.506 Disinfectants: Use of chlorine gas. ([NRS 439.200](#), [444.070](#))

1. Where equipment for the use of chlorine gas is provided, the mechanical proportioning device, required scales and cylinders of chlorine must be housed above grade in a reasonable gas-tight room which is mechanically vented and constructed of materials which are resistive to corrosion, and which is equipped with a door which opens outward to the outside.

2. Facilities in which chlorine gas is used must be provided with:

- (a) Equipment for fastening chlorine cylinders firmly in place.
- (b) Keys or valves on chlorine cylinders to permit quick shutoff in case of emergency.
- (c) A chlorine feeding device which will vent leaking chlorine gas to the outside and away from the spa during emergencies and interruptions in the water supply.
- (d) An airtight duct beginning near the floor of the room and ending at a safe point of discharge at least 8 feet (2.44 meters) above the surrounding grade outside.
- (e) A mechanical exhaust system capable of providing at least one air change per minute in the room.
- (f) An observation window at least 18 square inches (116.14 square centimeters) which provides a good view of the inside of the chlorine room.
- (g) Artificial illumination of at least 20 foot-candles which permits a person to observe and maintain equipment in the room.
- (h) Switches for the control of artificial lighting and ventilation, located outside the room and near the door.
- (i) A gas mask designed for use in a chlorine atmosphere, of a type approved by an appropriate federal agency and stored in a closed, unlocked cabinet located outside the room with a replacement canister and a record book in which mask usage can be recorded.
- (j) Personnel trained to the satisfaction of the health authority in handling chlorine and chlorination equipment.
- (k) A means to keep the temperature inside the room housing the chlorine metering equipment at a minimum temperature of 55 degrees Fahrenheit (12.8 degrees Celsius).
- (l) A sign stating "CAUTION - CHLORINE GAS" placed on the outside of the door to the chlorinator room.
- (m) A leakage test kit consisting of ammonia water and a sponge swab.
- (n) A placard posted outside the storage enclosure for cylinders of chlorine gas which has first-aid measures described on it and the telephone number of the supplier of the chlorine gas.
- (o) A chlorine gas detector with an audible alarm for each storage enclosure for cylinders of chlorine gas. [Bd. of Health, Public Spa Reg. Art. 25 §§ 25.3-25.3.10, eff. 11-27-79]—(NAC A 11-2-88)

NAC 444.507 Disinfectants: Storage of chlorine gas. ([NRS 439.200](#), [444.070](#)) Cylinders of chlorine gas must not be stored:

1. Where they are exposed to direct sunlight;
 2. Where they are readily accessible to the public; or
 3. In buildings where sleeping guests are housed.
- (Added to NAC by Bd. of Health, eff. 11-2-88)

NAC 444.508 Disinfectants: Test equipment. ([NRS 439.200](#), [444.070](#)) Each spa must be provided with an approved test kit for the determination of pH, disinfectant residuals and total alkalinity. At spas where chlorinated cyanurates are used, a test kit must be provided for cyanuric acid concentrations.

[Bd. of Health, Public Spa Reg. Art. 25 § 25.6, eff. 11-27-79]

NAC 444.510 Heating units. ([NRS 439.200](#), [444.070](#))

1. All heating units must be separated from the spa enclosure or protected to prevent injury to bathers and other persons.

2. Heater parts must be easily isolated and removed for cleaning.
3. The manufacturer's recommendations for manual bypass installation must be followed.
4. Temperature control must be maintained by thermostat.

[Bd. of Health, Public Spa Reg. Art. 15 §§ 15.2-15.3, eff. 11-27-79]

NAC 444.512 Equipment enclosure. ([NRS 439.200](#), [444.070](#))

1. Filters, pumps, motors, chemical feeders and other accessory equipment must be enclosed in a protective enclosure.
 2. Floor drainage must be provided within the protective enclosure.
 3. Lighting and ventilation for enclosed rooms must be provided in the enclosure.
- [Bd. of Health, Public Spa Reg. Art. 27, eff. 11-27-79]

Operation**NAC 444.520 Operating permits. ([NRS 439.200](#), [444.070](#), [444.080](#))**

1. No person may operate a public spa unless he or she has applied for and received an operating permit from the health authority.
 2. Permits expire 1 year after the date of issue unless previously revoked for a violation of the statutes and regulations of the State Board of Health or the local board of health.
 3. A temporary permit may be issued in exceptional cases for a limited time to permit management to make changes in order to comply with the minimum requirements. Safeguards must be provided to protect the health and safety of the bathers during the time that a temporary permit is in effect.
 4. The permit must be posted in a conspicuous place at or near the office of each spa.
 5. An operating permit is not transferable, and applies only to the public spa for which it is issued. When the spa is transferred or sold, the new owner must apply for and obtain a new operating permit from the health authority within 30 days of the sale or transfer.
- [Bd. of Health, Public Spa Reg. Art 3 §§ 3.1, 3.1.2, 3.1.3 & 3.1.5, eff. 11-27-79]

NAC 444.521 Fees for permits and review of plans. ([NRS 439.150](#), [439.200](#), [444.070](#), [444.080](#))

1. The Health Division shall charge and collect \$332 for each annual permit to operate a public spa, except in areas where the laws and regulations governing public spas are administered by local health authorities.
 2. The Health Division shall charge and collect \$370 for reviewing plans for a new public spa, except in areas where the laws and regulations governing public spas are administered by local health authorities.
 3. The Health Division shall charge and collect \$285 for reviewing plans for a remodeled public spa which has a permit, except in areas where the laws and regulations governing public spas are administered by local health authorities.
- (Added to NAC by Bd. of Health, eff. 7-20-82; A 6-23-86; 7-22-87; 8-31-89; 1-16-96; R193-03, 1-22-2004; R100-07, 10-31-2007)

NAC 444.522 Records. ([NRS 439.200](#), [444.070](#))

1. A written record of all data pertaining to the operation and sanitation of a public spa must be maintained by the management and made available to the health authority at all times.
 2. This record must include:
 - (a) Amounts of various chemicals used daily;
 - (b) The approximate amount of water added each day;
 - (c) A daily check of water temperature;
 - (d) Results of chemical tests for pH and chlorine;
 - (e) Date on which the spa was emptied or the filters were cleaned;
 - (f) Flowmeter readings;
 - (g) Names of all attendants; and
 - (h) Any other information which the health authority requires.
- [Bd. of Health, Public Spa Reg. Art. 5, eff. 11-27-79]

NAC 444.524 Heater and temperature requirements. ([NRS 439.200](#), [444.070](#))

1. Water temperature in a therapy pool must be maintained above 70°F (21.11°C), and must not be artificially heated above 104°F (40.0°C).

2. Signs must be posted which state that:

EXTENDED EXPOSURE TO HOT WATER OR VAPORS MAY BE DETRIMENTAL TO THE HEALTH OF ELDERLY PERSONS AND PERSONS WITH HEART CONDITIONS, DIABETES, OR HIGH OR LOW BLOOD PRESSURE.

[Bd. of Health, Public Spa Reg. Art. 15 §§ 15.1 & 15.1.1, eff. 11-27-79]

NAC 444.526 Safety requirements. (NRS 439.200, 444.070)

1. The spa must be free of protrusions, extensions, means of entanglement or other obstructions which might cause submerged entrapment of, or injury to, a bather.

2. Except as otherwise provided in subsection 7 of [NAC 444.484](#), no person may use a spa alone. No children 12 years of age or younger who are not supervised by an adult may use a spa.

3. Spa covers and solar blankets may only be used when the spa is closed unless the spa cover or solar blanket is secured around the entire spa perimeter and is designed and able to support the weight of an adult person.

4. A sign with at least 4-inch letters on a contrasting background must be posted near the spa which indicates that children 12 years of age or younger must be supervised by an adult and that the maximum recommended time for such children to use the spa is 10 minutes.

[Bd. of Health, Public Spa Reg. Art. 28 §§ 28.1 & 28.4, eff. 11-27-79]—(NAC A 11-2-88; 1-16-96)

NAC 444.528 First aid. (NRS 439.200, 444.070)

1. Each spa or spa facility must be equipped with a standard 16-unit first-aid kit which must be kept filled and ready for use at a convenient place near the spa.

2. The person who is in charge of the spa must have completed a course in standard first aid which is acceptable to the health authority.

[Bd. of Health, Public Spa Reg. Art. 25 §§ 25.4 & 25.5, eff. 11-27-79]—(NAC A 11-2-88)

NAC 444.530 Notices which must be posted. (NRS 439.200, 444.070)

1. Placards directing behavior of bathers must be prominently posted in locker rooms, offices, showers, toilets or elsewhere about the spa enclosure.

2. A sign must be posted in the immediate vicinity of the spa, stating the location of the nearest telephone with the information that emergency telephone numbers are posted on or near the telephone.

3. Emergency telephone numbers must be posted on or near the telephone and must include:

(a) The name and telephone number of the police, fire and rescue unit responsible for serving the spa.

(b) The name and telephone number of the nearest available physician.

(c) The name and telephone number of the nearest ambulance service.

(d) The name and telephone number of the nearest available hospital.

(e) In lieu of the telephone numbers listed in paragraphs (a) to (d), inclusive, the number for the emergency 911 service if that emergency service is available in the geographical area of the spa.

[Bd. of Health, Public Spa Reg. Art. 3 § 3.1.4 + Art. 28 §§ 28.5-28.5.4, eff. 11-27-79]—(NAC A 1-16-96)

NAC 444.532 Health requirements. (NRS 439.200, 444.070)

1. No person who has any communicable disease may be employed in any capacity at any public spa.

2. Any person who is or suspected by the health authority or the management to be afflicted with an infectious disease or suffering from a cough, cold, fever or sores, must be excluded from the spa area.

3. Any person who is suspected by the operator of being under the influence of alcohol, drugs or the like must not be permitted to enter the spa.

4. Since high temperature, the presence of excess oil on the skin and difficulties of maintaining a chlorine residual enhance the possibility of microbial growth and disease transmission, no person may be allowed to enter a spa which maintains less than 1.0 ppm (1.0 mg/l) of free chlorine.

[Bd. of Health, Public Spa Reg. Art. 29, eff. 11-27-79]

NAC 444.534 Capacity. ([NRS 439.200](#), [444.070](#))

1. The number of persons allowed to enter a spa must be limited to a number which allows 10 square feet (0.93 square meters) of water surface area for each person using the spa.
2. A sign must be posted within the spa area which states the maximum number of people allowed in the spa at one time.

[Bd. of Health, Public Spa Reg. Art. 30, eff. 11-27-79]

NAC 444.536 Visitor and spectator areas; food and drink. ([NRS 439.200](#), [444.070](#))

1. Spaces used by visitors and spectators must be separated from spaces used by bathers.
2. Food or drink must not be permitted in the immediate area of the spa or on the deck which surrounds it.

[Bd. of Health, Public Spa Reg. Art. 16, eff. 11-27-79]

Violations

NAC 444.540 Notice of violation. ([NRS 439.200](#), [444.070](#)) When the health authority inspects a public spa and finds a violation of the provisions of [NAC 444.310](#) to [444.546](#), inclusive, which does not seriously endanger the public health, the health authority shall issue a written notice of the violation to the owner or his or her representative and give a reasonable time for correction.

[Bd. of Health, Public Spa Reg. Art. 4 § 4.1, eff. 11-27-79]

NAC 444.542 Suspension or denial of operating permit. ([NRS 439.200](#), [444.070](#), [444.080](#), [444.100](#))

1. The health authority may order a suspension of an operating permit, and order the owner or operator of a public spa to prohibit persons from using it if the health authority finds:

- (a) A failure of spa equipment, structure, area or enclosure which endangers the health or safety of the persons using or operating it.
- (b) That the spa lacks properly functioning equipment or proper material for recirculating, treating or testing the spa water.
- (c) That the operator of the spa is not maintaining the required water quality.
- (d) That the operator does not have a valid operating permit.
- (e) Serious or repeated violations of any of the requirements of [NAC 444.310](#) to [444.546](#), inclusive, or interference with the health authority in the performance of his or her duties.

2. The health authority may deny an application for an operating permit if the applicant fails to:

- (a) Notify the health authority before construction and completion of the facility or bathing place;
- (b) Allow inspection of the public bathing or swimming facility or natural bathing place during or after its construction; or
- (c) Follow any of the requirements set forth in [NRS 444.065](#) to [444.120](#), inclusive, and [NAC 444.310](#) to [444.546](#), inclusive.

[Bd. of Health, Public Spa Reg. Art. 4 §§ 4.2 & 4.2.1-4.2.5, eff. 11-27-79]—(NAC A 10-30-97)

NAC 444.544 Order for closure; revocation of suspended permit. ([NRS 439.200](#), [444.070](#), [444.100](#))

1. The health authority may close public spas which are not operating according to the provisions of [NAC 444.310](#) to [444.546](#), inclusive.

2. When the health authority orders the closing of a public spa, the health authority shall issue a written order to the spa owner or operator or his or her representative stating the particular reason or reasons for the order of closure, along with the finding that the condition or conditions giving rise to the order represent a serious threat to the public health and safety.

3. The order must state that the spa is to be closed immediately and specify the corrective action necessary for the reinstatement of the operating permit.

4. The health authority shall serve the order upon the owner, operator, representative or a person in charge of the public spa. The person on whom the order is served shall close the spa immediately and shall prohibit any person from using it.

5. The owner, operator or representative of the person in charge of a public spa who has his or her

permit suspended must comply with the requirements of the written notice of suspension within the time stated in the notice. If the corrections ordered in the notice are not made within the time allowed, the permit to operate may be revoked.

[Bd. of Health, Public Spa Reg. Art 4 § 4.3, eff. 11-27-79]—(NAC A 11-2-88; 10-30-97)

NAC 444.545 Procedure for review of actions taken by Health Division; appeals. ([NRS 439.200](#), [444.070](#), [444.100](#))

1. A person who has reason to believe that an action taken by the Health Division pursuant to [NAC 444.310](#) to [444.546](#), inclusive, is incorrect or based on inadequate knowledge may, within 10 business days after receiving notice of the action, request an informal discussion with the employee responsible for the action and the immediate supervisor of the employee.

2. If the informal discussion does not resolve the problem, the aggrieved person may, within 10 business days after the date scheduled for the informal discussion, submit a written request to the Bureau for an informal conference. The informal conference must be scheduled for a date, place and time mutually agreed upon by the aggrieved person and the Bureau, except that the informal conference must be held no later than 60 days after the date on which the Bureau received the written request.

3. Except as otherwise provided in subsection 4, the determination of the Bureau resulting from the informal conference cannot be appealed and is the final remedy available to the aggrieved person.

4. An applicant for or holder of a permit or license issued pursuant to [NAC 444.310](#) to [444.546](#), inclusive, who is aggrieved by an action of the Health Division relating to the denial of an application for or renewal of such a permit or license or the suspension or revocation of such a permit or license may appeal that action in accordance with [NAC 439.300](#) to [439.395](#), inclusive, after exhausting the informal procedures set forth in this section, except that the Bureau may waive the informal procedures, or any portion thereof, by giving written notice to the aggrieved person.

5. As used in this section, "Bureau" means the Bureau of Health Protection Services of the Health Division or its successor.

(Added to NAC by Bd. of Health, eff. 10-30-97)

NAC 444.546 Reinspection. ([NRS 439.200](#), [444.070](#), [444.100](#))

1. After corrective action has been taken, the owner or operator or his or her representative shall notify the health authority that the spa is ready for reinspection.

2. If upon reinspection the corrective action is approved, the health authority may order the reinstatement of the operating permit, at which time the spa may be opened for use.

3. If upon reinspection the corrective action is not approved, the operating permit must remain suspended and the spa must be kept closed and out of use until corrections are approved.

[Bd. of Health, Public Spa Reg. Art. 4 §§ 4.4-4.6, eff. 11-27-79]

SANITATION FACILITIES FOR CAMPING SPACES

NAC 444.5461 Definitions. ([NRS 439.200](#)) As used in [NAC 444.5461](#) to [444.54675](#), inclusive, unless the context otherwise requires:

1. "Camping space" means a plainly marked plot of ground designated for:

- (a) The occupation of a camping vehicle or other vehicle;
- (b) The erection of a tent or shelter;
- (c) The parking of a camping vehicle or other vehicle; or
- (d) The arrangement of bedding.

2. "Camping vehicle" means a travel trailer, whose overall length does not exceed 32 feet and whose body width does not exceed 8 feet, a pickup camper or similar vehicular dwelling used for travel, vacation or recreational purposes, occupied in any one place for 30 days or less.

3. "Health authority" means officers and agents of the Health Division or officers and agents of the local boards of health.

4. "Person" includes governmental agencies.

5. "Sanitary station" means a facility used for removing and disposing of wastes from camping vehicle

retention tanks.

6. "Service building" means a building provided to house sanitary facilities.

[Bd. of Health, Sanitation Facilities for Camping Vehicles Reg. No. 1, eff. 11-21-70]—(NAC A 10-30-97; R195-03, 1-22-2004)

NAC 444.54615 Severability. ([NRS 439.200](#)) If any of the provisions of [NAC 444.5461](#) to [444.54675](#), inclusive, or any application thereof to any person, thing, or circumstance is held invalid, it is intended that such invalidity not affect the remaining provisions, or their application, that can be given effect without the invalid provision or application.

[Bd. of Health, Sanitation Facilities for Camping Vehicles Reg. No. 14, eff. 11-21-70]—(Substituted in revision for NAC 461A.510)

NAC 444.5462 Scope; effect on local standards. ([NRS 439.200](#)) [NAC 444.5461](#) to [444.54675](#), inclusive, contain minimum standards. Nothing contained in those sections precludes local health agencies or governmental units from formulating and adopting additional standards or standards in excess of those set forth in those sections.

[Bd. of Health, Sanitation Facilities for Camping Vehicles Reg. No. 12, eff. 11-21-70]—(Substituted in revision for NAC 461A.520)

NAC 444.54625 Applicability: Facilities in operation on November 21, 1970; subsequent construction or alteration. ([NRS 439.200](#)) Those facilities in operation on November 21, 1970, must obtain a permit. All sanitary requirements must be followed, but the health authority may waive deficiencies in existing structures. After November 21, 1970, construction or major alterations must comply fully with [NAC 444.5461](#) to [444.54675](#), inclusive, regarding construction or alteration.

[Bd. of Health, Sanitation Facilities for Camping Vehicles Reg. No. 13, eff. 11-21-70]—(Substituted in revision for NAC 461A.530)

NAC 444.5463 Conformity with requirements; approval for construction; notification of health authority; inspections; permit. ([NRS 439.200](#))

1. All sanitation facilities for camping spaces in Nevada which are constructed, reconstructed or extensively altered after November 21, 1970, must conform to the requirements in [NAC 444.5461](#) to [444.54675](#), inclusive.

2. Approval for construction of sanitation facilities for camping spaces must be obtained from all appropriate state and local agencies before commencing construction.

3. Any person providing camping spaces must notify the health authority at least 30 days before their intended use and must furnish the following information:

- (a) Names and addresses of owners or operators;
- (b) Location of facilities;
- (c) Size of camp and facilities;
- (d) Number of camping spaces available;
- (e) Water availability;
- (f) Sewage system and sanitation facilities;
- (g) Garbage facilities; and
- (h) Availability of open pit fires or enclosed fire facilities.

4. The health authority may inspect camping facilities annually or as often as deemed necessary and prepare a written report on the camp. An official permit will be given only once, and again when the facilities change ownership. A person must possess an unrevoked permit for camping space facilities issued by the health authority in the name of that person before operating sanitation facilities for camping spaces.

[Bd. of Health, Sanitation Facilities for Camping Vehicles Reg. No. 2, eff. 11-21-70]—(NAC A 10-30-97; R195-03, 1-22-2004)—(Substituted in revision for NAC 461A.540)

NAC 444.54635 Fees for permits and review of plans. ([NRS 439.150](#), [439.200](#))

1. The Health Division shall charge and collect fees for an annual permit to operate a facility for sanitation for camping spaces in accordance with the following schedule, except in areas where the laws and regulations governing such facilities are administered by local health authorities:

For a permit to operate a facility having 30 or less camping spaces.....	\$166
For a permit to operate a facility having more than 30 camping spaces.....	166
Plus \$1.50 for each camping space over 30.	

2. The Health Division shall charge and collect the following fees for reviewing plans of facilities for sanitation for camping spaces, except in areas where the laws and regulations governing such facilities are administered by local health authorities:

For a plan for a new facility.....	\$166
Plus \$1.50 for each camping space over 30.	
For a plan for remodeling a facility which has a permit.....	100
Plus \$1.50 for each camping space over 30.	

(Added to NAC by Bd. of Health, eff. 7-20-82; A 6-23-86; R195-03, 1-22-2004; R100-07, 10-31-2007)

NAC 444.5464 Location and layout of camping spaces. ([NRS 439.200](#))

1. Camping spaces must be located on a well-drained site and may not create a public health hazard or nuisance.

2. Camping spaces must be arranged in a manner so that there will be a minimum of 15 feet between camping spaces or other structures, and so that each camping space will be at least 5 feet from any road, public walkway or the exterior boundary of the property.

[Bd. of Health, Sanitation Facilities for Camping Vehicles Reg. No. 3, eff. 11-21-70]—(NAC A by R195-03, 1-22-2004)—(Substituted in revision for NAC 461A.550)

NAC 444.54645 Supply of water. ([NRS 439.200](#), [445A.860](#))

1. Any person providing camping spaces shall provide an adequate supply of drinking water from an approved source. It must be of a safe, sanitary quality, meeting the requirements of [NAC 445A.450](#) to [445A.492](#), inclusive.

2. The development of an independent water supply to serve the camping spaces must not be made without prior approval by the health authority.

3. Water must be available within 100 feet of every camping space. Overflow from faucets must empty into a drain connected to a disposal system or sump approved by the health authority.

4. Persons providing camping spaces must conspicuously post unapproved sources in the immediate vicinity as unfit for drinking if, in the opinion of the health authority, there is a likelihood of these sources being used for human consumption.

[Bd. of Health, Sanitation Facilities for Camping Vehicles Reg. No. 5, eff. 11-21-70]—(NAC A by R088-00, 8-3-2001; R195-03, 1-22-2004)—(Substituted in revision for NAC 461A.560)

NAC 444.5465 Service buildings; toilets. ([NRS 439.200](#))

1. Any person providing camping spaces shall provide toilet facilities, separate for the sexes, in conveniently located buildings.

2. Flush-type toilets and hand-washing facilities must be provided unless a supply of water under adequate pressure is not available, or other conditions preclude the use of such facilities.

3. Toilet rooms, shower rooms and other service buildings must have adequate illumination, where a power source is available. The average illumination level for general seeing tasks in these rooms are to be 5 foot-candles. In the work area of laundry rooms and at mirrors in toilet rooms, a minimum of 40 foot-candles must be provided.

4. These rooms must be well ventilated with all openings screened, to exclude flying insects, and constructed of material permitting satisfactory cleaning.

5. Floors in a service building must be constructed of water-impervious material, well pitched to a floor drain. The floor must be free from cracks or uneven surfaces that interfere with proper cleaning.

6. Partitions must be raised 12 inches from the floor and must be so constructed as to be easily cleaned. All service buildings and sanitary facilities must be kept in good repair.

7. There must be a minimum of one toilet for each sex for every 10 camping spaces or major fraction thereof. Urinals may be substituted for one-third of the toilets for males. A camping space used by a camping vehicle with a toilet facility is exempt from the toilet requirements if the camping space has an individual sewer connection and is used exclusively by the camping vehicle. However, in no case may there be less than one toilet provided for each sex.

8. Toilet paper must be provided at each toilet and hand towels provided in each restroom.

[Bd. of Health, Sanitation Facilities for Camping Vehicles Reg. No. 6, eff. 11-21-70]—(NAC A by R195-03, 1-22-2004)—(Substituted in revision for NAC 461A.570)

NAC 444.54655 Storage, collection and disposal of refuse. ([NRS 439.200](#))

1. The storage, collection and disposal of refuse at facilities for camping spaces must be conducted to create no health hazards, rodent harborage, insect breeding areas, accident or fire hazards or air pollution.

2. All refuse must be stored in flyproof, watertight, rodent-proof containers which are located not more than 150 feet from any camping space. Containers must be maintained on collection stands designed to prevent tipping and must be provided in sufficient number and capacity to properly store all refuse.

3. Where suitable collection service is not available from municipal or private agencies, the operator of the facilities for camping spaces must provide this service.

4. All refuse must be collected and transported in covered vehicles or covered containers to an approved disposal site or disposed of by other methods approved by the health authority or air pollution control authorities.

[Bd. of Health, Sanitation Facilities for Camping Vehicles Reg. No. 8, eff. 11-21-70]—(NAC A by R195-03, 1-22-2004)—(Substituted in revision for NAC 461A.580)

NAC 444.5466 Disposal of sewage; plumbing. ([NRS 439.200](#), [444.650](#))

1. All liquid wastes from service buildings and camping vehicles, including sink wastes, must be discharged into a public sewer or private sewage disposal system approved by the health authority. These wastes must be disposed of in accordance with [NAC 444.750](#) to [444.8396](#), inclusive.

2. All plumbing must comply with principles stated in the *Uniform Plumbing Code*.

3. Sewer riser pipe, if provided for camping vehicles having toilet facilities, must be at least 4 inches in diameter and must be provided with a standard threaded fitting to assure a watertight connection. Each connection must be closed when not linked to a camping vehicle.

4. An approved sanitary station, according to subsection 5, must be provided and toilet wastes from retention tanks of camping vehicles must be discharged through the sanitary station.

5. Sanitary stations:

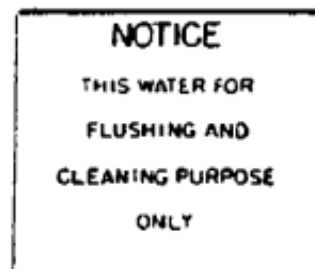
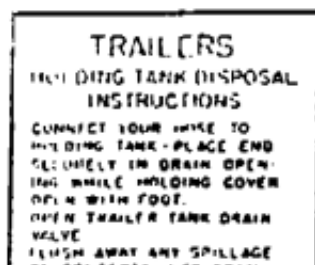

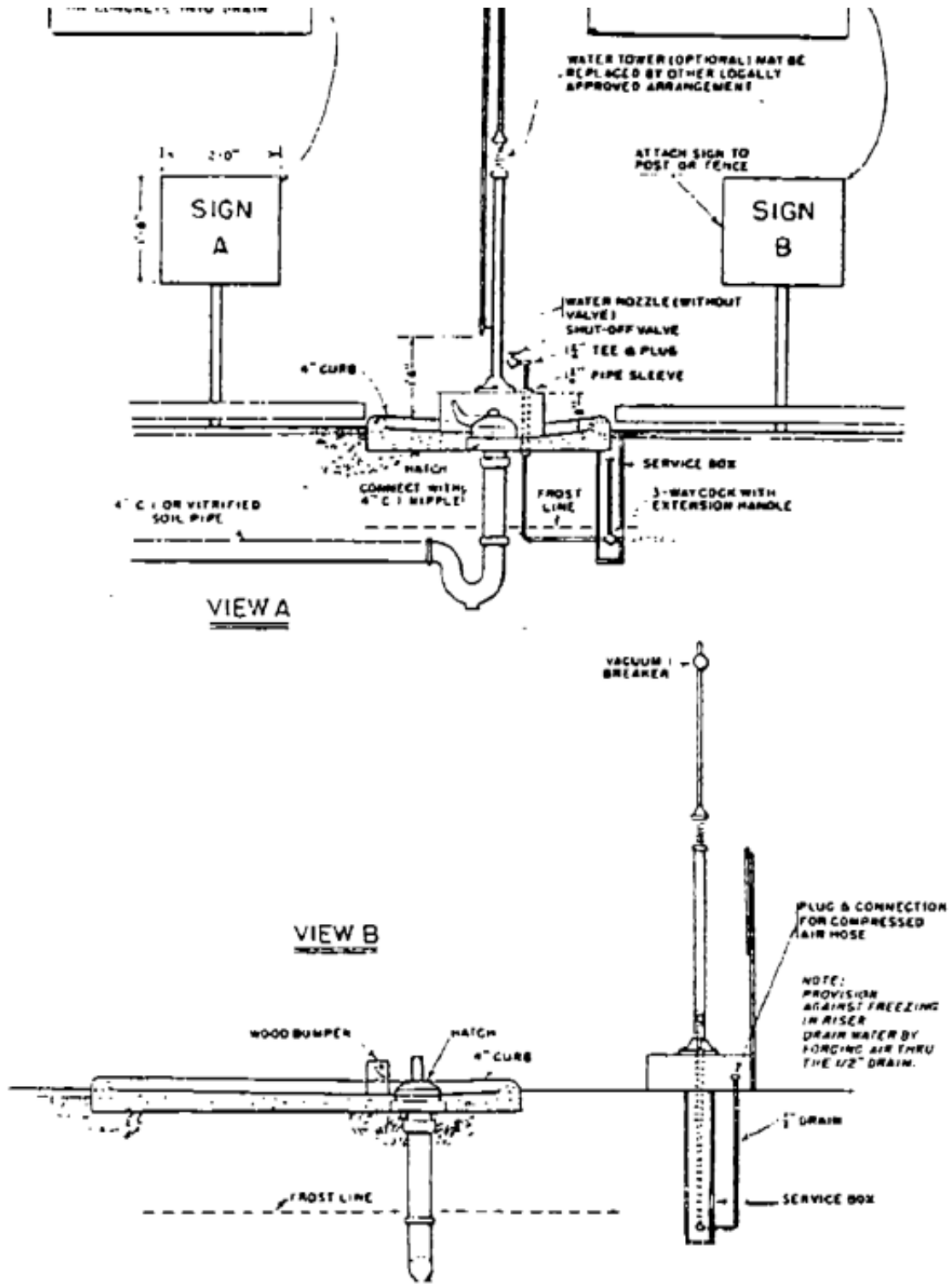

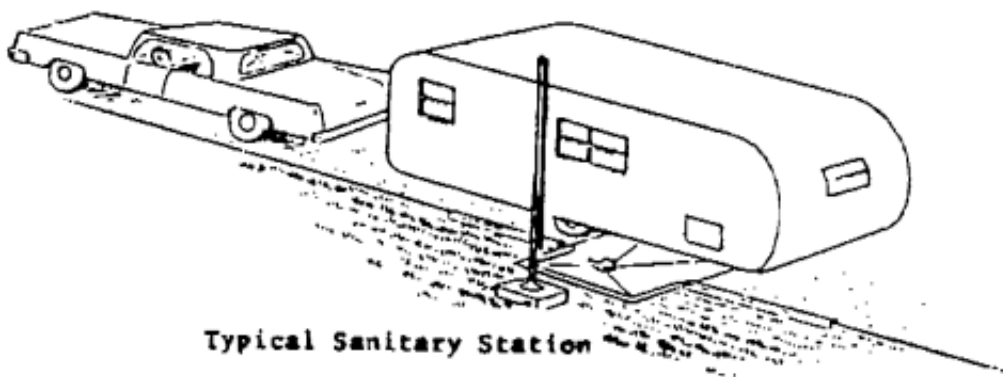
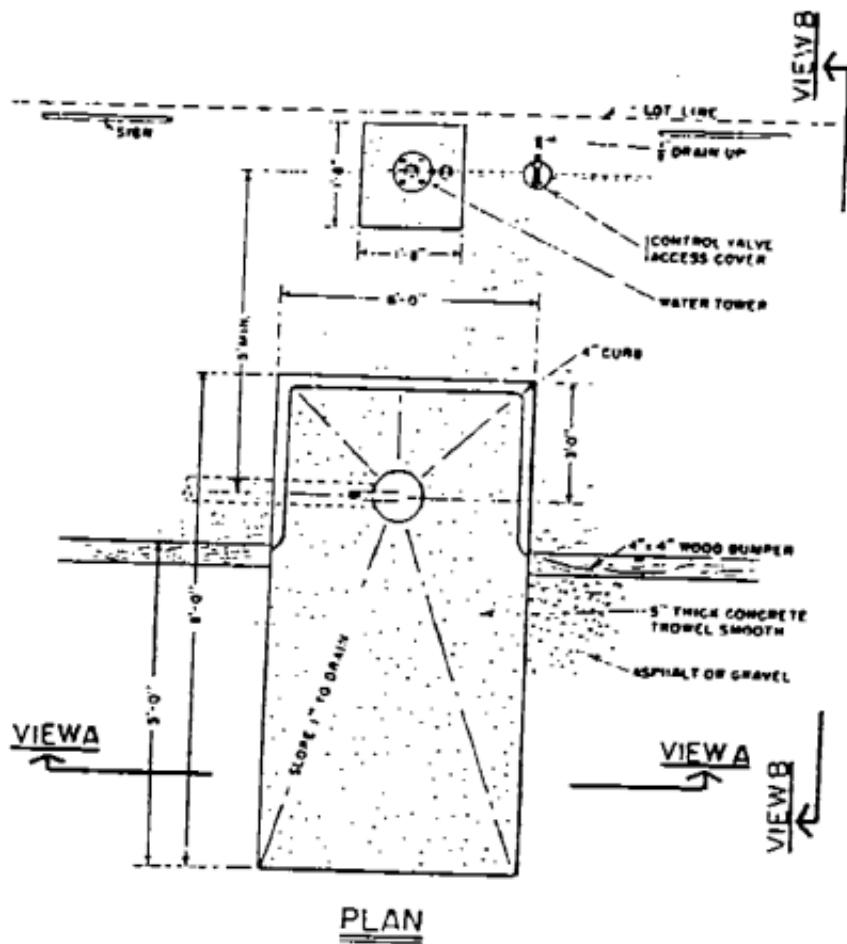

[Bd. of Health, Sanitation Facilities for Camping Vehicles Reg. No. 7, eff. 11-21-70]—(NAC A by R129-98, 3-25-99)—(Substituted in revision for NAC 461A.590)

NAC 444.54665 Responsibility for sanitation. (NRS 439.200) Persons providing camping spaces and service buildings are responsible for maintaining the premises in a clean and sanitary condition.

[Bd. of Health, Sanitation Facilities for Camping Vehicles Reg. part No. 4, eff. 11-21-70]—(NAC A by R195-03, 1-22-2004)—(Substituted in revision for NAC 461A.600)

NAC 444.5467 Control of vermin and pets. (NRS 439.200)

1. Appropriate measures must be taken to control rodent and insect infestations.

2. Dogs, cats or other pets are not permitted to run at large or to commit any nuisance within the camping area.

[Bd. of Health, Sanitation Facilities for Camping Vehicles Reg. part No. 4, eff. 11-21-70]—(Substituted in revision for NAC 461A.610)

NAC 444.54675 Enforcement by health authority; review and appeal of action taken by Health Division. (NRS 439.200)

1. Whenever the health authority finds unsanitary or other conditions or violations of [NAC 444.5461](#) to [444.54675](#), inclusive, in the operation and maintenance of facilities for camping spaces, the health authority shall:

(a) In the case where the health authority determines that a substantial and immediate hazard to public health or safety exists, take any of the following actions:

(1) Revoke the permit;

(2) Remove or abate such hazards;

(3) Take necessary steps to protect persons from such hazards; or

(4) Notify the permit holder or operator and any person who might be affected by such hazardous conditions, require specific corrective action and specify the time period within which such action must be taken.

(b) In all other cases, issue a notice of violation to the permit holder or operator citing such conditions, specifying the corrective action to be taken, and specifying the time period within which action must be taken.

2. If the permit holder or operator fails to comply with a notice of violation, the permit must be revoked.

3. A permit may be revoked without notice if the health authority determines that a substantial and immediate hazard to public health and safety exists.

4. A person who has reason to believe that an action taken by the Health Division pursuant to [NAC 444.5461](#) to [444.54675](#), inclusive, is incorrect or based on inadequate knowledge may, within 10 business days after receiving notice of the action, request an informal discussion with the employee responsible for the action and the immediate supervisor of the employee.

5. If the informal discussion does not resolve the problem, the aggrieved person may, within 10 business days after the date scheduled for the informal discussion, submit a written request to the Bureau for an informal conference. The informal conference must be scheduled for a date, place and time mutually agreed upon by the aggrieved person and the Bureau, except that the informal conference must be held no later than 60 days after the date on which the Bureau received the written request.

6. Except as otherwise provided in subsection 7, the determination of the Bureau resulting from the informal conference cannot be appealed and is the final remedy available to the aggrieved person.

7. An applicant for or holder of a permit issued pursuant to [NAC 444.5461](#) to [444.54675](#), inclusive, who is aggrieved by an action of the Health Division relating to the denial of an application for or the suspension or revocation of such a permit may appeal that action in accordance with [NAC 439.300](#) to [439.395](#), inclusive, after exhausting the informal procedures set forth in this section, except that the Bureau may waive the informal procedures, or any portion thereof, by giving written notice to the aggrieved person.

8. Nothing in this section prevents the health authority from extending the time allowed for corrective action when the permit holder provides a written response within 10 days after receiving a notice of violation setting forth the nature and time needed for corrective action. The health authority shall require periodic reports as may be necessary to demonstrate reasonable progress toward final compliance.

9. As used in this section, "Bureau" means the Bureau of Health Protection Services of the Health Division or its successor.

[Bd. of Health, Sanitation Facilities for Camping Vehicles Reg. No. 11, eff. 11-21-70]—(NAC A 10-30-97; R195-03, 1-22-2004)—(Substituted in revision for NAC 461A.620)

TEMPORARY MASS GATHERINGS

General Provisions

NAC 444.547 Definitions. ([NRS 439.200](#)) As used in [NAC 444.547](#) to [444.5498](#), inclusive, unless the context otherwise requires, the words and terms defined in [NAC 444.5471](#) to [444.5479](#), inclusive, have the meanings ascribed to them in those sections.

(Added to NAC by Bd. of Health by R071-03, eff. 10-22-2003)

NAC 444.5471 “Food establishment” defined. ([NRS 439.200](#)) “Food establishment” has the meaning ascribed to it in [NRS 446.020](#).

(Added to NAC by Bd. of Health by R071-03, eff. 10-22-2003)

NAC 444.5472 “Operator of a temporary mass gathering” defined. ([NRS 439.200](#)) “Operator of a temporary mass gathering” means the person responsible for the operation of a temporary mass gathering. The term includes, but is not limited to, the holder of a permit to operate a temporary mass gathering issued by the health authority.

(Added to NAC by Bd. of Health by R071-03, eff. 10-22-2003)

NAC 444.5473 “Potable water” defined. ([NRS 439.200](#)) “Potable water” has the meaning ascribed to it in [NAC 444.7664](#).

(Added to NAC by Bd. of Health by R071-03, eff. 10-22-2003)

NAC 444.5474 “Public bathing or swimming facility” defined. ([NRS 439.200](#)) “Public bathing or swimming facility” has the meaning ascribed to it in [NAC 444.058](#).

(Added to NAC by Bd. of Health by R071-03, eff. 10-22-2003)

NAC 444.5475 “Public spa” defined. ([NRS 439.200](#)) “Public spa” has the meaning ascribed to it in [NAC 444.385](#).

(Added to NAC by Bd. of Health by R071-03, eff. 10-22-2003)

NAC 444.5476 “Solid waste” defined. ([NRS 439.200](#)) “Solid waste” has the meaning ascribed to it in [NRS 444.490](#).

(Added to NAC by Bd. of Health by R071-03, eff. 10-22-2003)

NAC 444.5477 “Temporary food establishment” defined. ([NRS 439.200](#)) “Temporary food establishment” has the meaning ascribed to it in [NRS 446.067](#).

(Added to NAC by Bd. of Health by R071-03, eff. 10-22-2003)

NAC 444.5478 “Temporary mass gathering” defined. ([NRS 439.200](#)) “Temporary mass gathering” means an outdoor assembly of persons with an actual or reasonably anticipated daily attendance of not fewer than 500 persons that operates or may reasonably be expected to operate not less than 20 hours a day for more than 3 days and takes place at a location that lacks permanent facilities specifically intended for the type of assembly involved.

(Added to NAC by Bd. of Health by R071-03, eff. 10-22-2003)

NAC 444.5479 “Water station” defined. ([NRS 439.200](#)) “Water station” means a facility for dispensing potable water for immediate human consumption. The term includes a drinking fountain.

(Added to NAC by Bd. of Health by R071-03, eff. 10-22-2003)

Operating Permit

NAC 444.548 Requirement; application; expiration; posting. (NRS 439.200)

1. A person shall not operate a temporary mass gathering unless he or she first obtains a permit to do so from the health authority.
 2. A person desiring to obtain a permit to operate a temporary mass gathering must apply to the health authority on an application provided by the health authority. The application must include, without limitation:
 - (a) The full name and mailing address of the applicant.
 - (b) A statement specifying whether the applicant is a natural person, firm or corporation, and, if the applicant is a partnership, the names and addresses of the partners.
 - (c) The location of the temporary mass gathering.
 - (d) A description of the type of temporary mass gathering.
 - (e) The inclusive dates and hours of operation of the temporary mass gathering.
 - (f) The number of persons that the applicant anticipates will attend the temporary mass gathering.
 3. The application for a permit to operate a temporary mass gathering must be:
 - (a) Received by the health authority not later than 30 days before the first day of the temporary mass gathering.
 - (b) Signed by the applicant or a person authorized by the applicant to sign on his or her behalf.
 - (c) Accompanied by:
 - (1) The fee established by the health authority.
 - (2) A detailed plan of the site of the temporary mass gathering. The plan must identify:
 - (I) The location, types and number of toilet facilities and facilities for hand washing.
 - (II) The location and a description of each water station and the source of the water for each station.
 - (III) The location and identity of each food establishment, including each temporary food establishment, and the type of food to be served at each establishment.
 - (IV) The location, types and number of containers for the collection or storage of solid waste and the name of the provider of the containers.
 - (V) The location of the headquarters of the operator.
 - (VI) The location of each public bathing or swimming facility and public spa.
 4. The health authority may require an applicant to provide any additional information that the health authority determines is reasonably necessary to protect the public health.
 5. Unless the health authority provides an earlier expiration date, a permit to operate a temporary mass gathering expires at midnight on the 30th day of operation of the gathering. A permit to operate a temporary mass gathering may not be renewed.
 6. A permit to operate a temporary mass gathering must be posted in the headquarters of the operator at the site of the gathering.
- (Added to NAC by Bd. of Health by R071-03, eff. 10-22-2003)

NAC 444.5482 Fees. (NRS 439.150, 439.200) The Health Division shall charge and collect fees for a permit to operate a temporary mass gathering in accordance with the following schedule, except in areas where the laws and regulations governing temporary mass gatherings are administered by local health authorities:

For a permit to operate a temporary mass gathering with an anticipated attendance of:	Fee per day
500 to 1,000 persons.....	\$500
1,001 to 5,000 persons.....	750
5,001 to 10,000 persons.....	1,000
10,001 or more persons.....	2,644

(Added to NAC by Bd. of Health by R071-03, eff. 10-22-2003; A by R100-07, 10-31-2007)

Standards of Operation

NAC 444.5484 Maintenance of headquarters. (NRS 439.200) The operator of a temporary mass gathering shall:

1. Maintain a headquarters at the site of the gathering.
2. Ensure that a natural person designated by the operator is:
 - (a) Present at the headquarters of the operator at all times that the temporary mass gathering is in operation; and
 - (b) Authorized to take immediate action to correct or terminate a violation of any provision of [NAC 444.547](#) to [444.5498](#), inclusive, identified to him or her by the health authority.

(Added to NAC by Bd. of Health by R071-03, eff. 10-22-2003)

NAC 444.5486 Removal of solid waste. (NRS 439.200)

1. The operator of a temporary mass gathering shall remove all solid waste from the site of the gathering within a reasonable time after the end of the gathering.
2. If, during the operation of a temporary mass gathering, the health authority determines that an accumulation of solid waste is a nuisance:
 - (a) The health authority shall notify the operator of the gathering; and
 - (b) The operator shall, within a reasonable time after being notified, abate the nuisance.
3. As used in this section, "nuisance" has the meaning ascribed to it in [NAC 444.594](#).

(Added to NAC by Bd. of Health by R071-03, eff. 10-22-2003)

NAC 444.5488 Operation of food establishment. (NRS 439.200)

1. Except as otherwise provided in [NRS 446.870](#), the operator of a temporary mass gathering shall not operate, or allow another person to operate, a food establishment, including a temporary food establishment, at the gathering unless the person operating the food establishment:
 - (a) Possesses a valid permit issued to him or her by the health authority; and
 - (b) Complies with the applicable provisions of:
 - (1) [Chapter 446](#) of NRS; and
 - (2) The regulations of the State Board of Health, or the local board of health, adopted pursuant to [chapter 446](#) of NRS.

2. For the purposes of this section, a person who sells, offers or displays for sale or serves, at a temporary mass gathering, water, including water dispensed from a water station, or ice intended for ultimate human consumption operates a food establishment or temporary food establishment.

(Added to NAC by Bd. of Health by R071-03, eff. 10-22-2003)

NAC 444.549 Provision of potable water; disposal of graywater. (NRS 439.200)

1. The operator of a temporary mass gathering shall ensure that each person who attends the gathering:
 - (a) Provides sufficient potable water to meet his or her individual needs; and
 - (b) Disposes of his or her graywater in a manner approved by the health authority or transports it away from the site of the gathering for disposal.
2. The operator of a temporary mass gathering shall not engage, or allow another person to engage, in the bulk transportation of water to the site of the temporary mass gathering for the purpose of consumption or external use unless the person so engaged has first obtained the approval of the health authority pursuant to [NAC 445A.6728](#) to engage in water hauling.
3. As used in this section, "graywater" means untreated wastewater that has not come into contact with toilet waste. The term includes, without limitation, used water from bathtubs, showers, washbasins, kitchen sinks, dishwashers, machines for washing clothes and laundry tubs.

(Added to NAC by Bd. of Health by R071-03, eff. 10-22-2003)

NAC 444.5492 Provision of toilet facilities; removal and disposal of contents of nonsewered toilets. (NRS 439.200)

1. The operator of a temporary mass gathering shall provide toilet facilities as set forth in [NAC 444.825](#) unless the health authority reduces the number of toilet facilities otherwise required pursuant to [NAC 444.825](#)

by the number of public toilet facilities available.

2. The operator of a temporary mass gathering shall provide at least one facility for hand washing at each group of toilet facilities provided by the operator pursuant to subsection 1.

3. An operator of a temporary mass gathering shall not operate, or allow another person to operate, a service to provide nonsewered toilets at the gathering unless the person operating the service has obtained a permit in accordance with [NAC 444.820](#), [444.826](#) and [444.828](#).

4. An operator of a temporary mass gathering shall not engage, or allow another person to engage, in the operation of removing and disposing of the solid and liquid contents of nonsewered toilets at the temporary mass gathering unless the person so engaged has obtained a permit as a septic tank pumping contractor in accordance with [NAC 444.820](#), [444.821](#), [444.822](#) and [444.828](#).

5. As used in this section, "nonsewered toilet" has the meaning ascribed to it in [NAC 444.7654](#).
(Added to NAC by Bd. of Health by R071-03, eff. 10-22-2003)

NAC 444.5494 Discharge of water used to provide dust control. ([NRS 439.200](#)) The operator of a temporary mass gathering shall not discharge, or allow another person to discharge, water onto the ground to provide dust control at the gathering unless:

1. If the water used is potable:

- (a) The source of the water is licensed by the Health Division and approved by the health authority; and
- (b) Each vehicle used to transport the water, and each tank used to discharge the water, is:
 - (1) Approved by the Bureau of Health Protective Services of the Health Division; and
 - (2) Used for no other purpose than the transportation or discharge of potable water.

2. If the water used is nonpotable, the tank from which the water is discharged is marked "NONPOTABLE WATER, AVOID CONTACT" on each side and on the rear of the water tank. The lettering used to mark the tank must be legible, of a color that contrasts with the color of the water tank and, unless the health authority otherwise approves, not less than 4 inches in height. The health authority shall not approve lettering that is less than 4 inches in height unless there is insufficient room on the tank for such lettering.

(Added to NAC by Bd. of Health by R071-03, eff. 10-22-2003)

NAC 444.5496 Operation of public bathing or swimming facility or public spa. ([NRS 439.200](#))

1. The operator of a temporary mass gathering shall not operate, or permit another person to operate, a public bathing or swimming facility at the gathering unless the person operating the public bathing or swimming facility:

- (a) Possesses a permit to do so from the health authority; and
- (b) Complies with all applicable provisions of:
 - (1) [NRS 444.065](#) to [444.120](#), inclusive; and
 - (2) [NAC 444.010](#) to [444.306](#), inclusive, or the regulations adopted by the local board of health.

2. The operator of a temporary mass gathering shall not operate, or permit another person to operate, a public spa at the gathering unless the person operating the public spa:

- (a) Possesses a permit to do so from the health authority; and
- (b) Complies with all applicable provisions of:
 - (1) [NRS 444.065](#) to [444.120](#), inclusive; and
 - (2) [NAC 444.310](#) to [444.546](#), inclusive, or the regulations adopted by the local board of health.

(Added to NAC by Bd. of Health by R071-03, eff. 10-22-2003)

Enforcement

NAC 444.5498 Inspection by health authority. ([NRS 439.200](#)) The health authority may conduct any inspection reasonably necessary to enforce any provision of [NAC 444.547](#) to [444.5498](#), inclusive.

(Added to NAC by Bd. of Health by R071-03, eff. 10-22-2003)

LABOR CAMPS

NAC 444.550 Applicability. ([NRS 439.200](#), [444.190](#)) [NAC 444.550](#) to [444.566](#), inclusive, do not apply to facilities for permanent family or individual occupancy, nor to facilities or premises assigned to an employee for his or her exclusive use or convenience. The application of these sections is not intended to apply to temporary ranching activities, including buckarooing or the roundup and moving of sheep and cattle. [Bd. of Health, Labor Camp Reg. § 8, eff. 1-29-59]—(NAC A 10-30-97)

NAC 444.552 General standards. ([NRS 439.200](#), [444.190](#))

1. All housing and housing grounds must be maintained in a clean, safe and sanitary condition, free from rubbish, debris, waste paper, garbage and other refuse. Grounds must also be well drained and free from depressions where water may stand.

2. All garbage, kitchen waste and rubbish in camp must be deposited in suitable covered metal receptacles which must be emptied daily, or more often if necessary, and the contents burned, buried or disposed of in a manner which is not or does not become offensive or insanitary.

3. Fly-tight metal containers must be provided adjacent to living and sleeping quarters for garbage and other refuse.

4. All drainage from kitchen sinks, toilets, baths or laundry must be carried through a covered drain to a covered cesspool or septic tank, or otherwise disposed of in a manner which is not or does not become offensive or insanitary. Where public sewer systems are available, all building sewers must be connected.

5. An adequate and convenient supply of water of a quality that meets the standards of the water supply regulations in [chapter 445A](#) of NAC must be available at all times for drinking, cooking, bathing and laundry purposes.

6. Fresh and safe drinking water must be provided for all workers. Faucets must be suitably and conveniently located and in no event more than 100 yards distant from workers' living quarters. The use of a common drinking cup or drinking from a common container is prohibited, as is dipping into containers.

7. The water supply must be capable of delivering at least 36 gallons of water per person per day to the campsite.

8. Tanks or other receptacles used for storage of water must be kept in a clean and sanitary condition and must be suitably covered to prevent contamination.

9. Effective measures must be taken to control rats and flies, mosquitoes, bedbugs and other insects or parasites within the camp premises.

10. All buildings or structures of a camp must be maintained and used in accordance with the provisions of state and local regulations governing safety and fire prevention. An adequate water supply for fire fighting should be available during occupancy.

11. No camp may be located on a site which is subject to or may cause extreme traffic or other hazard unless acceptable safeguards are provided.

[Bd. of Health, Labor Camp Reg. § 1, eff. 1-29-59]

NAC 444.554 Living and sleeping quarters. ([NRS 439.200](#), [444.190](#))

1. Living and sleeping spaces must be in good structural condition and constructed to provide shelter to the occupants against the elements and to exclude dampness.

2. The floors and roofing of all buildings must be in good condition. Floors of buildings used as living or sleeping quarters must be constructed of wood, asphalt, concrete or other comparable material. Dirt floors are not acceptable.

3. All buildings used as living or sleeping quarters for 10 or more persons must have at least two outside exits, for use in case of fire, located to provide alternate means of escape.

4. Suitable and separate beds or cots must be provided for each worker. Where single beds are used, at least 40 square feet of floor space must be provided for each worker. Where double deck bunks are used, 35 square feet of floor space per worker is required. Every sleeping space must contain at least 350 cubic feet of air space for each occupant.

5. Where double deck bunks are used, ceiling height should be at least 12 feet from the floor. At least 4 feet of clear space should be allowed between each set of double bunks.

6. Triple deck bunks are not acceptable.

7. Where beds or bunks are used, mattresses and mattress covers must be provided and kept in a clean

and sanitary condition.

8. Every sleeping room must have one or more windows with an aggregate area of not less than 10 percent of the floor space of the room.

9. All windows must be arranged so that at least 45 percent of their aggregate area may be opened, except where there is supplied some other approved device affording adequate ventilation. All windows must be fitted with screening of at least 16 mesh.

10. All doors and outside openings in living and sleeping quarters must be secured with screens not less than 16 mesh. All screen doors must be equipped with self-closing devices.

11. When a camp is operated during a season and in a climate requiring artificial heating, all living quarters must be adequately heated in such a way as to ensure the comfort and safety of the occupants.

12. A stove or other source of heat must be installed and vented to avoid a fire hazard and a dangerous concentration of fumes or gas. In a room with wooden or combustible flooring, there must be a concrete slab, metal sheet or other fire resistant material on the floor under every stove, extending at least 18 inches beyond the perimeter of the base of the stove. Any wall or ceiling not having a fire resistant surface within 24 inches of a stove or stovepipe must be protected by a metal sheet or other fire resistant material. Heating appliances, other than electrical, must be provided with a stovepipe or vent connected to the appliance and discharging to the outside air or chimney. Such vent or chimney must extend above the peak of the roof. A vented metal collar must be installed around a stovepipe, vent or flue in a wall, ceiling, floor or roof through which the stovepipe, vent or flue passes.

13. Automatically operated heat-producing equipment must be provided with controls to cut off the fuel supply upon the failure or interruption of flame or ignition, or whenever a predetermined safe temperature or pressure is exceeded. All steam and hot water systems must be provided with safety devices arranged to prevent hazardous pressures and excessive temperatures.

14. All living and sleeping quarters must be maintained in a clean and sanitary condition. Floors must be scrubbed with hot water and suitable cleansing agents once a week and more often if necessary.

[Bd. of Health, Labor Camp Reg. § 2, eff. 1-29-59]

NAC 444.556 Cooking and eating facilities. (NRS 439.200, 444.190)

1. Every structure used as a mess hall where food is cooked, prepared or served must be kept in a clean and sanitary condition.

2. The same standards relative to ventilation, window space and screening, and means of exit which apply to living and sleeping quarters also apply to cooking and eating facilities.

3. The size of cooking and eating facilities must be in proper proportion to the capacity of the camp and separate from sleeping quarters. In all cases, however, cooking and eating space must be in addition to the minimum space requirements for sleeping.

4. For workers required to board themselves, sufficient cooking stoves, tables, seats and fuel for cooking must be provided. One oil, wood or gas stove, with not less than one burner for each five workers is required. Outdoor cooking facilities, unprotected from inclement weather, are not acceptable.

5. Table tops on all tables used in mess halls must have a smooth, hard surface which may be easily cleaned.

6. Provision must be made for the safe storage and refrigeration of food in a suitable and sanitary place away from sleeping quarters.

7. Garbage disposal and drainage from kitchen sinks must meet the requirements described under the general standards for labor camp sanitation.

8. Kitchens for group food service must comply with at least the grade B requirements set for food and drink establishments in [chapter 446](#) of NAC.

[Bd. of Health, Labor Camp Reg. § 3, eff. 1-29-59]

NAC 444.558 Sanitary facilities. (NRS 439.200, 444.190)

1. Convenient and suitable bathing facilities maintained in a sanitary condition must be provided in each camp, readily accessible to the living quarters.

2. Where showers are provided there must be at least one shower head in operating condition for every 25 workers. After January 29, 1959, all new construction must provide for at least one shower head for each

15 workers.

3. The floors and walls of the shower compartments must be constructed and maintained in waterproof condition. Floor drains are required in all shower rooms to remove wastewater.

4. Each shower must have adequate hot and cold water under pressure.

5. Where tubs are used there must be one No. 3 size tub in good condition for every five workers.

6. Provision must be made for adequate dressing space adjacent to bathing facilities.

7. All toilet facilities must be maintained in a clean and sanitary condition at all times.

8. All exterior openings in toilet buildings must be screened with wire mesh of not less than 16 mesh.

9. Toilet rooms must be ventilated in conformity with the requirements in this respect which apply to living and sleeping quarters and cooking and eating facilities.

10. At least one usable enclosed toilet must be provided for each 10 workers and must be located within 150 feet of the living quarters. Toilet facilities may not be located in a sleeping room.

11. Where privy-type toilets are used they must consist of a fly- and rodent-tight pit that should be at least 4 feet deep, with a well-constructed shelter, the openings of which shall be effectively screened and fly-tight. When the excreta reaches a point 1 foot below the surface of the ground the pit must be filled and the shelter demolished or moved over a new pit. All excreta in a pit must be covered with earth, ashes, lime or some similar substance at least every 48 hours.

12. Privy toilets must not be located closer than 75 feet to any sleeping place or any kitchen or mess hall.

13. Where 10 or more are employed, urinals may be provided. Adequate washing facilities must be provided in every toilet room or adjacent to it.

14. All sanitary facilities must be inspected regularly by management to assure that they are operating properly.

[Bd. of Health, Labor Camp Reg. § 4, eff. 1-29-59]

NAC 444.560 Laundry facilities. ([NRS 439.200](#), [444.190](#))

1. Laundry facilities must be maintained in a sanitary condition and provided with adequate drainage as described in [NAC 444.552](#).

2. At least one laundry tray, wash tub or other laundry facility must be provided for every 10 workers or fraction of 10, and must be convenient to all living quarters. Hot and cold water must be provided at each laundry tray or wash tub.

[Bd. of Health, Labor Camp Reg. § 6, eff. 1-29-59]

NAC 444.562 Lighting. ([NRS 439.200](#), [444.190](#))

1. All habitable rooms must be well lighted. Rooms used for living quarters and mess hall must be equipped with ceiling-type light fixtures arranged to provide at least 10 foot-candles of light to every part of the room. Water closet compartments, privies, laundry rooms and toilets must contain at least one ceiling or wall-type fixture.

2. Electric wiring must be installed in accordance with provisions of the *National Electric Code*.

3. Where electricity is not available, at least one lamp must be provided for every five workers.

[Bd. of Health, Labor Camp Reg. § 5, eff. 1-29-59]

NAC 444.564 Operating permit: Application; issuance; denial, suspension or revocation. ([NRS 439.200](#), [444.190](#))

1. Before operating a labor camp, the operator must apply for a permit to operate, submit sufficient plans for review by the Health Division and pay the required fees.

2. Within a reasonable period after receipt of an application for a permit to operate a labor camp, plans of the labor camp and the required fees, the Health Division shall review the application and plans submitted for accuracy and completeness. Upon receipt of an application that it determines to be complete, the Health Division shall conduct an inspection to determine whether the facility complies with [NAC 444.550](#) to [444.566](#), inclusive.

3. The Health Division shall issue a permit to operate a labor camp if the labor camp is in compliance with [NAC 444.550](#) to [444.566](#), inclusive.

4. The Division may deny, suspend or revoke a permit to operate a labor camp if the applicant fails to:

- (a) Notify the health authority before construction and completion of the labor camp;
 - (b) Allow inspection of the labor camp during or after its construction; or
 - (c) Follow any of the requirements set forth in [NRS 444.130](#) to [444.200](#), inclusive, and [NAC 444.550](#) to [444.566](#), inclusive.
- [Bd. of Health, Labor Camp Reg. § 7, eff. 1-29-59]—(NAC A 10-30-97)

NAC 444.565 Procedure for review of actions taken by Health Division; appeals. ([NRS 439.200](#), [444.190](#))

1. A person who has reason to believe that an action taken by the Health Division pursuant to [NAC 444.550](#) to [444.566](#), inclusive, is incorrect or based on inadequate knowledge may, within 10 business days after receiving notice of the action, request an informal discussion with the employee responsible for the action and the immediate supervisor of the employee.

2. If the informal discussion does not resolve the problem, the aggrieved person may, within 10 business days after the date scheduled for the informal discussion, submit a written request to the Bureau for an informal conference. The informal conference must be scheduled for a date, place and time mutually agreed upon by the aggrieved person and the Bureau, except that the informal conference must be held no later than 60 days after the date on which the Bureau received the written request.

3. Except as otherwise provided in subsection 4, the determination of the Bureau resulting from the informal conference cannot be appealed and is the final remedy available to the aggrieved person.

4. An applicant for or holder of a permit or license issued pursuant to [NAC 444.550](#) to [444.566](#), inclusive, who is aggrieved by an action of the Health Division relating to the denial of an application for or the renewal of such a permit or license or the suspension or revocation of such a permit or license may appeal that action in accordance with [NAC 439.300](#) to [439.395](#), inclusive, after exhausting the informal procedures set forth in this section, except that the Bureau may waive the informal procedures, or any portion thereof, by giving written notice to the aggrieved person.

5. As used in this section, "Bureau" means the Bureau of Health Protection Services of the Health Division or its successor.

(Added to NAC by Bd. of Health, eff. 10-30-97)

NAC 444.566 Fees for permits and review of plans. ([NRS 439.150](#), [439.200](#), [444.190](#))

1. For an annual permit to operate a labor camp, the Health Division shall charge and collect \$166, plus \$1.25 for each five workers above 30 workers in the camp, except in areas where the laws and regulations governing the sanitation of labor camps are administered by local health authorities.

2. The Health Division shall charge and collect the following fees for reviewing plans for labor camps as follows, except in areas where the laws and regulations governing the sanitation of labor camps are administered by local health authorities:

	\$124
For a plan for a new camp.....	
Plus \$1.25 for each five workers above 30 workers in the camp.	
For a plan to remodel a camp which has a permit.....	83
Plus \$1.25 for each five workers above 30 workers in the camp.	

(Added to NAC by Bd. of Health, eff. 7-20-82; A 6-23-86; R100-07, 10-31-2007)

SCHOOLS

NAC 444.568 Definitions. ([NRS 439.200](#), [444.335](#)) As used in [NAC 444.568](#) to [444.56862](#), inclusive, unless the context otherwise requires, the words and terms defined in [NAC 444.56802](#) to [444.56812](#), inclusive, have the meanings ascribed to them in those sections.

(Added to NAC by Bd. of Health by R177-99, eff. 7-24-2002)

NAC 444.56802 “Charter school” defined. ([NRS 439.200](#), [444.335](#)) “Charter school” has the meaning ascribed to it in [NRS 385.007](#).
(Added to NAC by Bd. of Health by R177-99, eff. 7-24-2002)

NAC 444.56804 “Health authority” defined. ([NRS 439.200](#), [444.335](#)) “Health authority” has the meaning ascribed to it in [NRS 439.005](#).
(Added to NAC by Bd. of Health by R177-99, eff. 7-24-2002)

NAC 444.56806 “Private school” defined. ([NRS 439.200](#), [444.335](#)) “Private school” has the meaning ascribed to it in [NRS 394.103](#).
(Added to NAC by Bd. of Health by R177-99, eff. 7-24-2002)

NAC 444.56808 “Public nuisance” defined. ([NRS 439.200](#), [444.335](#)) “Public nuisance” has the meaning ascribed to it in [NRS 202.450](#).
(Added to NAC by Bd. of Health by R177-99, eff. 7-24-2002)

NAC 444.5681 “Public school” defined. ([NRS 439.200](#), [444.335](#)) “Public school” has the meaning ascribed to it in [NRS 385.007](#).
(Added to NAC by Bd. of Health by R177-99, eff. 7-24-2002)

NAC 444.56812 “School” defined. ([NRS 439.200](#), [444.335](#)) “School” means a charter school, private school or public school.
(Added to NAC by Bd. of Health by R177-99, eff. 7-24-2002)

NAC 444.56814 Severability of provisions. ([NRS 439.200](#), [444.335](#)) If any provision set forth in [NAC 444.568](#) to [444.56862](#), inclusive, or any application thereof to any person, thing or circumstance is held invalid, it is intended that the invalidity not affect the remaining provisions or applications to the extent that those provisions and applications can be given effect without the invalid provision or application.
(Added to NAC by Bd. of Health by R177-99, eff. 7-24-2002)

NAC 444.56816 Adoption by reference of certain publications; revision of certain publications after adoption. ([NRS 439.200](#), [444.335](#))

1. The State Board of Health hereby adopts by reference:

(a) The guidelines for playground safety set forth in the *Handbook for Public Playground Safety*, as those guidelines existed on July 24, 2002. A copy of the publication may be obtained, free of charge, from the United States Consumer Product Safety Commission, Office of Information and Public Affairs, Washington D.C. 20207, or at the Internet address <http://www.cpsc.gov/cpsc/pub/pubs/playpubs.html>.

(b) The *Recommended Practice on Lighting for Educational Facilities*, in the form most recently published by the Illuminating Engineering Society of North America. A copy of this publication may be obtained from the Illuminating Engineering Society of North America at the Internet address <https://www.iesna.org/shop/>, for the price of \$50.

(c) The *Uniform Plumbing Code*, in the form most recently published by the International Association of Plumbing and Mechanical Officials. A copy of this publication may be obtained from the International Association of Plumbing and Mechanical Officials by telephone at (800) 854-2766 or at the Internet address <http://iapmostore.org>, for the price of \$93.

(d) The standards of the American National Standards Institute set forth in ANSI Z358.1, *Emergency Eyewash and Shower Equipment*, in the form most recently published by the American National Standards Institute. A copy of the standards may be obtained from IHS Global Engineering Documents by telephone at (877) 413-5184 or at the Internet address <http://store.ihs.com>, for the price of \$85.

2. The State Board of Health will review each revision of the publications adopted by reference pursuant to paragraphs (b) and (c) of subsection 1 to ensure its suitability for this State. If the Board determines that a revision is not suitable for this State, the Board will hold a public hearing to review its determination within 6

months after the date of publication of the revision and give notice of that hearing. If, after the hearing, the Board does not revise its determination, the Board will give notice within 30 days after the hearing that the revision is not suitable for this State. If the Board does not give such notice, the revision becomes part of the publication adopted by reference.

(Added to NAC by Bd. of Health by R177-99, eff. 7-24-2002; A by R100-07, 10-31-2007)

NAC 444.56818 Submission and approval or denial of plans and specifications for construction. ([NRS 439.200](#), [444.335](#))

1. A person may not begin the construction of a school until the plans and specifications for the school are submitted to and approved by the health authority. The plans and specifications must include, without limitation:

(a) The layout, arrangement and construction materials for all rooms and grounds, including, without limitation, classrooms, utility rooms, janitors' closets and playgrounds; and

(b) The location, size and type of:

(1) Equipment that will be used at the school, including fixed equipment; and

(2) Facilities that will be included in the construction, including, without limitation, lavatories and kitchens.

2. The health authority shall review the plans and return a written decision of approval or denial to the person submitting the plans within 30 days after receipt of the plans. If the decision is to deny the plans, the written decision must include a detailed statement of the reasons for the denial.

3. As used in this section, "construction" means any construction of, remodeling of, additions made to, or other substantial alterations made to a school.

(Added to NAC by Bd. of Health by R177-99, eff. 7-24-2002)

NAC 444.5682 Schools constructed before July 24, 2002. ([NRS 439.200](#), [444.335](#)) A school that is constructed before July 24, 2002, shall be deemed to be in compliance with [NAC 444.568](#) to [444.56862](#), inclusive, if the use of the space in the school is not changed or any deficiency in the school does not constitute a substantial or an immediate threat to the health or safety of the general public.

(Added to NAC by Bd. of Health by R177-99, eff. 7-24-2002)

NAC 444.56822 Notification of health authority regarding health or safety hazard. ([NRS 439.200](#), [444.335](#))

1. If the superintendent or principal of a school or the designee of the superintendent or the principal determines that a substantial health or safety hazard exists at the school, the superintendent, the principal or the designee of the superintendent or the principal shall notify the health authority of:

(a) The hazard; and

(b) Any remedial action that has been taken to correct the hazard, within 24 hours after the determination is made.

2. As used in this section:

(a) "Public water system" has the meaning ascribed to it in [NRS 445A.235](#).

(b) "Substantial health or safety hazard" means any violation of the provisions of [NAC 444.568](#) to [444.56862](#), inclusive, that may endanger the health or safety of the general public. The term includes, without limitation:

(1) A loss of electrical power or any other utility in the school that causes the failure of a system which is required for the operation of the school, including, without limitation, a system for lighting, heating or cooling;

(2) A supply of potable water for the school that has not been approved by the health authority or does not comply with the provisions relating to sampling and notification of the general public set forth in [chapter 445A](#) of NRS and the regulations adopted pursuant thereto;

(3) The existence of a defect or condition in the public water system that supplies potable water to the school which may result in the contamination of the water;

(4) Sewage or liquid waste in the school that:

(I) Is disposed of in a manner which has not been approved by the health authority; or

- (II) Has contaminated any part of the school to which the general public has access;
 - (5) The presence of insects, rodents or other vermin in the school that constitutes a significant threat to the health or safety of the general public, as determined by the health authority;
 - (6) The presence of any toxic material in the school that is labeled, stored or used improperly;
 - (7) Toxic or noxious gases, vapors, fumes, mist or particulates that are present in the school in concentrations which are immediately dangerous to the life or health of a person present in the school or in concentrations which are sufficient to cause a public nuisance;
 - (8) Any condition or equipment used in the school that constitutes an unreasonable risk of crushing a person, puncturing or pinching the skin of a person or otherwise injuring a person by causing the person to fall, trip or sustain any physical injury;
 - (9) A classroom or any other room in the school that is occupied by pupils or members of the staff of the school and has ambient temperatures which constitute a significant threat to the health or safety of the pupils or members of the staff, as determined by the health authority; or
 - (10) A school in which toilets and facilities for washing hands are not provided or are not accessible.
- (Added to NAC by Bd. of Health by R177-99, eff. 7-24-2002)

NAC 444.56824 Inspections: Preparation and dissemination of reports by health authority; maintenance of other reports. ([NRS 439.200](#), [444.335](#))

1. The health authority shall prepare a written report of the findings of an inspection of a school required by [NRS 444.335](#) while on the premises of the school and provide a copy of the report to the principal of the school or any other person designated by the principal to receive the report at that time.
 2. In addition to the copy of the report provided pursuant to subsection 1, the health authority may provide a copy of the report to:
 - (a) The board of trustees of the school district in which the school is located, if the school is a public school;
 - (b) The governing body of the charter school, if the school is a charter school; or
 - (c) The Superintendent of Public Instruction, if the school is a private school.
 3. Any report which is prepared by any other authority which conducts a health or safety inspection of a school must be maintained by the school for the period prescribed by that authority and be available for review by the health authority upon request.
- (Added to NAC by Bd. of Health by R177-99, eff. 7-24-2002)

NAC 444.56826 Correction of deficiencies; reporting of corrective action taken or planned; reporting of noncompliance. ([NRS 439.200](#), [444.335](#))

1. Any deficiency indicated in a report of an inspection prepared pursuant to [NAC 444.56824](#) must be corrected within 30 days after the inspection unless otherwise indicated in the report.
2. Except as otherwise provided in subsection 3, the principal of the school which was inspected or his or her designee shall prepare a written report of corrective action taken or planned and submit that report to the health authority within 30 days after the inspection of the school.
3. The provisions of subsection 2 do not apply if:
 - (a) Corrective action was taken at the time of the inspection and the health authority indicates in the report of the inspection that the deficiency indicated in the report was corrected; or
 - (b) The health authority inspects the school again before the period set forth in subsection 2 expires and the health authority indicates in the report of the inspection that the deficiency previously indicated in the report was corrected.
4. If a school is not in compliance with the provisions of [NAC 444.568](#) to [444.56862](#), inclusive, the health authority may advise the following persons or entities of the noncompliance:
 - (a) The department of education;
 - (b) The board of trustees of the school district in which the school is located, if the school is a public school;
 - (c) The board of trustees of the school district that is the sponsor of the charter school, if the school is a charter school; or
 - (d) The Superintendent of Public Instruction, if the school is a private school.

(Added to NAC by Bd. of Health by R177-99, eff. 7-24-2002)

NAC 444.56828 Floors, walls and ceilings; benches, mats and other equipment. ([NRS 439.200](#), [444.335](#))

1. The floors, walls and ceilings in a school must be:
 - (a) Constructed of durable materials that are easy to clean and appropriate for their intended use; and
 - (b) Maintained in good repair.
 2. Benches, mats or any other equipment that is intended for use by more than one person must be:
 - (a) Constructed of nonabsorbent materials; and
 - (b) Clean, sanitary and in good repair.
- (Added to NAC by Bd. of Health by R177-99, eff. 7-24-2002)

NAC 444.5683 Lighting. ([NRS 439.200](#), [444.335](#)) Artificial sources of light that are permanently fixed in a school must be installed to provide lighting at luminance levels equal to or greater than those prescribed in tables 1 and 2 of the *Recommended Practice on Lighting for Educational Facilities*, adopted by reference pursuant to [NAC 444.56816](#).

(Added to NAC by Bd. of Health by R177-99, eff. 7-24-2002; A by R100-07, 10-31-2007)

NAC 444.56832 Temperature. ([NRS 439.200](#), [444.335](#)) The temperature in a classroom that is occupied by pupils or members of the staff of the school, other than an area used for teaching vocational education or for physical activities, including, without limitation, weight lifting, must be maintained at a level which is not less than 65 degrees Fahrenheit and not more than 85 degrees Fahrenheit. Every effort must be made to maintain a comfortable temperature after considering the humidity in each room.

(Added to NAC by Bd. of Health by R177-99, eff. 7-24-2002)

NAC 444.56834 Pets. ([NRS 439.200](#), [444.335](#))

1. Pets may be kept only in the designated areas of a school.
 2. An enclosure used for pets must be clean and sanitary to prevent odors and the accumulation of excrement.
 3. A pet that is on the premises of a school may be handled by a pupil only under the supervision of an adult. A pupil or member of the staff of the school shall wash his or her hands after handling a pet.
 4. A pet that is not housebroken or trained to use a litter box may not be allowed on the absorbent surfaces in the school.
 5. The provisions of this section do not apply to:
 - (a) A person with a visual, aural or other physical disability who is accompanied by a guide dog, hearing dog, helping dog or other service animal;
 - (b) A person who is accompanied by an animal described in paragraph (a) if the person is training the animal; or
 - (c) A peace officer who is performing his or her duties as a peace officer and is accompanied by a police dog.
 6. As used in this section:
 - (a) "Guide dog" has the meaning ascribed to it in [NRS 426.075](#).
 - (b) "Hearing dog" has the meaning ascribed to it in [NRS 426.081](#).
 - (c) "Helping dog" has the meaning ascribed to it in [NRS 426.083](#).
 - (d) "Police dog" has the meaning ascribed to it in [NRS 651.075](#).
 - (e) "Service animal" has the meaning ascribed to it in [NRS 426.097](#).
- (Added to NAC by Bd. of Health by R177-99, eff. 7-24-2002)

NAC 444.56836 Hazardous materials; laboratories. ([NRS 439.200](#), [444.335](#))

1. A unit for washing eyes in an emergency, in combination with or in addition to an accessible shower used in an emergency, must be provided in each classroom in which acid, caustic substances, flammable materials or other hazardous materials are handled. The unit for washing eyes and the shower for use in an

emergency must comply with the requirements set forth in ANSI Z358.1, as adopted by reference in [NAC 444.56816](#).

2. Countertops that are resistant to chemicals must be used in each classroom which is used as a chemistry laboratory.

3. A classroom that is used as a science laboratory must have a sink for washing hands which is conveniently located and equipped with:

- (a) Hot and cold water that is tempered by a mixing valve or combination faucet;
- (b) Hot water that is delivered at a maximum temperature of 110 degrees Fahrenheit;
- (c) A supply of soap or detergent for washing hands; and
- (d) A supply of disposable towels designed for a single use or a device that provides heated air for drying hands.

4. A classroom in which volatile chemicals are used or two or more chemicals are mixed and the reaction of those chemicals is likely to produce toxic or noxious gases, vapors, fumes or suspended particulates must be equipped with a fume hood. Any activity that produces toxic or noxious gases, vapors, fumes or suspended particulates must be conducted under the fume hood.

5. An aspirator or suction bulb must be used for drawing a liquid into a pipette.

6. Each chemical or biological reagent must be stored according to the instructions of the manufacturer. The area in which a chemical or biological reagent is stored must be:

- (a) Secure and accessible only to authorized members of the staff of the school;
- (b) Cool and dry;
- (c) Ventilated and free of objectionable odors; and
- (d) Clean and organized.

7. A reagent or other similar material that is stored in its original container must bear a legible label of the manufacturer. If a reagent or other similar material has been repackaged, it must be labeled to identify its contents and manner of use.

8. Eating, drinking or any other activity that involves contact between the hands and mouth of a person is prohibited in a classroom which is used as a science laboratory.

(Added to NAC by Bd. of Health by R177-99, eff. 7-24-2002)

NAC 444.56838 Materials, tools and other equipment; areas used for teaching vocational education. ([NRS 439.200](#), [444.335](#))

1. Machinery, tools or any other equipment that is used in an area of the school for teaching vocational education may be operated or used by a pupil only under the supervision of an adult.

2. An area that is used for teaching vocational education must be clean and organized.

3. Machinery, tools, material stock, hardware or any other equipment must be stored in a manner that prevents health and safety hazards.

4. Stationary equipment must be secured in place and arranged to provide for a work area which is of a sufficient size and which is free of hazards which may cause a person to fall, trip, slip or sustain any physical injury.

5. Instructions relating to safety and the operation of machinery, tools or other equipment must be posted conspicuously in the area in which the machinery, tools or other equipment is operated or used.

6. Cylinders of compressed gas must be secured in a manner that prevents the cylinders from tipping or falling.

7. An area used for teaching vocational education must have a sink for washing hands that is conveniently located and equipped with:

- (a) Hot and cold water that is tempered by a mixing valve or combination faucet;
- (b) Hot water that is delivered at a maximum temperature of 110 degrees Fahrenheit;
- (c) A supply of soap or detergent for washing hands; and
- (d) A supply of disposable towels designed for a single use or a device that provides heated air for drying hands.

(Added to NAC by Bd. of Health by R177-99, eff. 7-24-2002)

NAC 444.5684 Areas used for teaching home economics. ([NRS 439.200](#), [444.335](#))

1. Any area in a classroom that is used for home economics in which food is prepared or eaten must be maintained in a clean and sanitary condition.
2. Food must be stored and handled in a manner that prevents the rapid growth of pathogenic organisms, contamination and spoilage and prevents the harborage and feeding of insects and other vermin.
3. A classroom used for home economics must have a sink for washing hands that is conveniently located and equipped with:
 - (a) Hot and cold water tempered by a mixing valve or combination faucet;
 - (b) Hot water that is delivered at a maximum temperature of 110 degrees Fahrenheit;
 - (c) A supply of soap or detergent for washing hands; and
 - (d) A supply of disposable towels designed for a single use or a device that provides heated air for drying hands.

(Added to NAC by Bd. of Health by R177-99, eff. 7-24-2002)

NAC 444.56842 Health rooms. ([NRS 439.200](#), [444.335](#))

1. Each school shall provide a health room with beds, couches, mats, cots or other furniture that may be used for resting. The beds, couches, mats, cots and other furniture must be covered with a nonabsorbent material that is maintained in good repair and is cleaned and sanitized before each use.
2. Any medications that are stored in a health room must be accessible only to authorized members of the staff of the school.
3. As used in this section, "health room" means a room or an area where an ill or injured pupil is temporarily isolated until such time as the pupil is released to the custody of his or her parent or guardian.

(Added to NAC by Bd. of Health by R177-99, eff. 7-24-2002)

NAC 444.56844 Electrical panels, janitors' closets, boiler rooms and storage rooms. ([NRS 439.200](#), [444.335](#)) Electrical panels, janitors' closets, boiler rooms, storage rooms, including, without limitation, storage rooms for supplies and equipment, and rooms containing a transformer that are located in a school, must be locked and accessible only to authorized members of the staff of the school.

(Added to NAC by Bd. of Health by R177-99, eff. 7-24-2002)

NAC 444.56846 Playgrounds and playground equipment. ([NRS 439.200](#), [444.335](#)) Playgrounds and playground equipment must be designed, constructed and maintained in the manner prescribed in the guidelines set forth in the *Handbook for Public Playground Safety* as adopted by reference in [NAC 444.56816](#).

(Added to NAC by Bd. of Health by R177-99, eff. 7-24-2002)

NAC 444.56848 Programs for food service. ([NRS 439.200](#), [444.335](#)) A program used by a school to serve food must comply with:

1. The provisions of [chapter 446](#) of NRS and the regulations adopted pursuant thereto; and
2. Any ordinances, rules or regulations governing food establishments adopted by the appropriate district board of health, county board of health or board of county commissioners.

(Added to NAC by Bd. of Health by R177-99, eff. 7-24-2002)

NAC 444.5685 Water. ([NRS 439.200](#), [444.335](#))

1. Potable water of a sufficient amount to meet the requirements of a school must be provided to the school from a supplier that is approved by the health authority and licensed by the Health Division.
2. Water that is under pressure and maintained at the required temperature must be provided to all fixtures and equipment of the school which uses water. The system that provides hot water to the school must provide a sufficient amount of hot water to meet the requirements of the school during its hours of operation.
3. There must not be a cross connection between:
 - (a) The supply of potable water and any water that is nonpotable or may be nonpotable; or
 - (b) The supply of potable water and any source of pollution by which the potable water may become contaminated.

4. A system for supplying nonpotable water may be used only for air conditioning, cleaning, flushing toilets and fire protection, if the system is approved by the health authority and does not come into direct or indirect contact with the supply of potable water. The piping of a system for nonpotable water must be clearly and permanently identified so that it is readily distinguishable from piping which carries potable water.

5. The system for potable water must be installed to prevent backflow. Devices to prevent backflow and back siphonage must be installed on a fixture or equipment that does not have an air gap which is at least twice the diameter of the inlet for the water between the inlet and the flood level rim of the fixture. A hose may not be attached to a faucet unless a device to prevent backflow is installed.

6. A device to prevent backflow or back siphonage that is installed on a system for potable water must comply with the standards for the construction, installation, maintenance, inspection and testing for that specific application and type of device set forth in the *Uniform Plumbing Code*, as adopted by reference in [NAC 444.56816](#).

7. The use of lead solder on piping carrying potable water is prohibited.
(Added to NAC by Bd. of Health by R177-99, eff. 7-24-2002)

NAC 444.56852 Sewage. ([NRS 439.200](#), [444.335](#))

1. All sewage at a school, including liquid waste, must be disposed of in a manner that is approved by the health authority.

2. Facilities for the disposal of sewage that do not use water, including chemical toilets, are prohibited unless authorized by the health authority for temporary use.

(Added to NAC by Bd. of Health by R177-99, eff. 7-24-2002)

NAC 444.56854 Toilets, lavatories and drinking fountains. ([NRS 439.200](#), [444.335](#))

1. A minimum number of toilets, lavatories and drinking fountains must be installed in a school as prescribed in the standards for plumbing facilities of the *Uniform Plumbing Code*, as adopted by reference in [NAC 444.56816](#).

2. A toilet and lavatory must be located within 250 feet of each classroom and area used for teaching vocational education and be accessible for use at all times.

3. Toilets must be clean and in good repair. A supply of toilet tissue that is dispensed from a permanently affixed dispenser must be provided at each toilet at all times.

4. Each lavatory must provide hot and cold water that is tempered by a mixing valve or combination faucet. The hot water must be delivered at a maximum temperature of 110 degrees Fahrenheit. A faucet that closes automatically, closes slowly or is metered must provide a flow of water for not less than 20 seconds.

5. A supply of soap or detergent for washing hands must be available in each lavatory.

6. A supply of disposable towels designed for a single use or a device that provides heated air for drying hands must be conveniently located near each lavatory.

7. Lavatories must be clean and in good repair.

(Added to NAC by Bd. of Health by R177-99, eff. 7-24-2002)

NAC 444.56856 Drinking fountains and potable drinking water. ([NRS 439.200](#), [444.335](#))

1. Each drinking fountain in a school must be clean and in good repair.

2. Potable drinking water must be provided and dispensed in a sanitary manner in gymnasiums and during outdoor events held at the school.

(Added to NAC by Bd. of Health by R177-99, eff. 7-24-2002)

NAC 444.56858 Showers and shower fixtures. ([NRS 439.200](#), [444.335](#)) A shower that is provided in a school must have hot and cold water which is tempered by a mixing valve or combination fixture. The hot water must be delivered at a maximum temperature of 110 degrees Fahrenheit. Each shower and shower fixture must be clean and in good repair.

(Added to NAC by Bd. of Health by R177-99, eff. 7-24-2002)

NAC 444.5686 Garbage and refuse. ([NRS 439.200](#), [444.335](#))

1. There must be a sufficient number of containers located in a school to hold all garbage and refuse that accumulates in the school. The containers must be conveniently located throughout the school.
2. Garbage and refuse must be:
 - (a) Deposited in containers that are closable, durable, nonabsorbent, protected against vermin and clean; and
 - (b) Stored in a manner that is not accessible to insects and rodents.
3. Storage areas or enclosures which are located outside a school must be clean and of sufficient size to store the containers of garbage and refuse.
4. Containers for garbage and refuse which are located outside a school must be:
 - (a) Stored on a smooth surface of concrete or asphalt;
 - (b) Clean and in good repair; and
 - (c) Maintained in a manner that does not cause a public nuisance.
5. If the health authority or public works department of the appropriate local government requires a school to install an interceptor for grease, the interceptor must be maintained in a manner that does not cause a public nuisance.
6. Garbage and refuse must be removed from the premises of the school at such times as is necessary to prevent the garbage and refuse from developing an odor, causing a public nuisance or attracting insects and rodents, but in any event the garbage and refuse must be disposed of within intervals of 7 days, unless otherwise approved by the health authority.
(Added to NAC by Bd. of Health by R177-99, eff. 7-24-2002)

NAC 444.56862 Control of vermin. (NRS 439.200, 444.335)

1. Measures must be taken to minimize the presence of rodents, flies, cockroaches or other vermin on the premises of a school, including regular inspections to detect the presence of those vermin. The premises of the school, including the contiguous land or property under the control of the school, must be maintained in a condition that prevents or eliminates the harboring or feeding of insects, rodents and other vermin.
2. Insecticides, herbicides and rodenticides must be used in accordance with the directions on the label of the container and stored in a manner that is accessible only to authorized members of the staff of the school.
(Added to NAC by Bd. of Health by R177-99, eff. 7-24-2002)

SOLID WASTE DISPOSAL

General Provisions

NAC 444.570 Definitions. (NRS 444.560) As used in [NAC 444.570](#) to [444.7499](#), inclusive, unless the context otherwise requires, the words and terms defined in [NAC 444.5701](#) to [444.631](#), inclusive, have the meanings ascribed to them in those sections.
(Supplied in codification; A by Environmental Comm'n, 12-19-89; 9-2-92; 11-8-93; 3-1-94; R034-98, 4-17-98; R173-99, 2-9-2000)

NAC 444.5701 "Active life" defined. (NRS 444.560) "Active life" means the period of operation of a disposal site beginning with the initial receipt of solid waste and ending at the completion of closure activities in accordance with [NAC 444.6891](#), [444.6892](#) and [444.6893](#).
(Added to NAC by Environmental Comm'n, eff. 11-8-93)

NAC 444.5702 "Administrator" defined. (NRS 444.560) "Administrator" means the Administrator of the Division of Environmental Protection of the State Department of Conservation and Natural Resources.
(Added to NAC by Environmental Comm'n, eff. 11-8-93)

NAC 444.5703 "Appendix I" defined. (NRS 444.560) "Appendix I" means the Appendix I of 40 C.F.R. Part 258.
(Added to NAC by Environmental Comm'n, eff. 11-8-93)

NAC 444.57035 “Appendix II” defined. ([NRS 444.560](#)) “Appendix II” means the Appendix II of 40 C.F.R. Part 258.

(Added to NAC by Environmental Comm’n, eff. 11-8-93)

NAC 444.5704 “Aquifer” defined. ([NRS 444.560](#)) “Aquifer” means a geological formation, group of formations or portion of a formation capable of yielding usable quantities of groundwater to wells and springs.

(Added to NAC by Environmental Comm’n, eff. 11-8-93)

NAC 444.57048 “Cell” defined. ([NRS 444.560](#)) “Cell” means a portion of a municipal solid waste landfill unit which consists of compacted wastes completely enclosed in cover material.

(Added to NAC by Environmental Comm’n, eff. 11-8-93)

NAC 444.5705 “Class I site” defined. ([NRS 444.560](#)) “Class I site” means a disposal site which:

1. Is comprised of at least one municipal solid waste landfill unit including all contiguous land and structures, other appurtenances and improvements on the land used for the disposal of solid waste; and
2. Is not a Class II or Class III site.

(Added to NAC by Environmental Comm’n, eff. 9-2-92; A 11-8-93)

NAC 444.571 “Class II site” defined. ([NRS 444.560](#)) “Class II site” means a disposal site:

1. Which is comprised of at least one municipal solid waste landfill unit;
2. Which accepts less than 20 tons of solid waste per day on an annual average;
3. For which there is no evidence of contamination of groundwater originating from the site;
4. Which serves a community that has no other practicable alternatives for waste management; and
5. Which is located in an area which annually receives no more than 25 inches of precipitation.

Ê The term includes all contiguous land and structures, other appurtenances and improvements on the land used for the disposal of solid waste.

(Added to NAC by Environmental Comm’n, eff. 9-2-92; A 11-8-93)

NAC 444.5715 “Class III site” defined. ([NRS 444.560](#)) “Class III site” means a disposal site which accepts only industrial solid waste.

(Added to NAC by Environmental Comm’n, eff. 9-2-92; A 11-8-93)

NAC 444.572 “Composting” defined. ([NRS 444.560](#)) “Composting” means a controlled process of biological degradation of solid waste to an inoffensive humus-like product.

[Environmental Comm’n, Solid Waste Mgt Reg. § 1.1, eff. 9-21-77]

NAC 444.573 “Contaminant” defined. ([NRS 444.560](#)) “Contaminant” has the meaning ascribed to it in [NRS 445A.325](#).

(Added to NAC by Environmental Comm’n, eff. 9-2-92)

NAC 444.5735 “Cross-media” defined. ([NRS 444.560](#)) “Cross-media” means the transfer of a constituent from a medium such as water, land or air, to another medium.

(Added to NAC by Environmental Comm’n, eff. 11-8-93)

NAC 444.574 “Disposal site” defined. ([NRS 444.560](#)) “Disposal site” has the meaning ascribed to it in [NRS 444.460](#).

[Environmental Comm’n, Solid Waste Mgt Reg. § 1.2, eff. 9-21-77]

NAC 444.576 “Division” defined. ([NRS 444.560](#)) “Division” means the Division of Environmental Protection of the State Department of Conservation and Natural Resources.

[Environmental Comm’n, Solid Waste Mgt Reg. § 1.3, eff. 9-21-77]

NAC 444.577 “Existing municipal solid waste landfill unit” defined. ([NRS 444.560](#)) “Existing municipal solid waste landfill unit” means a municipal solid waste landfill unit which is receiving waste on November 8, 1993.

(Added to NAC by Environmental Comm’n, eff. 11-8-93)

NAC 444.578 “Garbage” defined. ([NRS 444.560](#)) “Garbage” means putrescible animal and vegetable wastes resulting from the handling, storage, sale, preparation, cooking and serving of food.

(Environmental Comm’n, Solid Waste Mgt Reg. § 1.4, eff. 9-21-77]

NAC 444.5785 “Gas condensate” defined. ([NRS 444.560](#)) “Gas condensate” means the liquid generated as a result of any processes to recover gas at a municipal solid waste landfill unit.

(Added to NAC by Environmental Comm’n, eff. 11-8-93)

NAC 444.579 “Groundwater” defined. ([NRS 444.560](#)) “Groundwater” means all subsurface water comprising the zone of saturation, including perched water.

(Added to NAC by Environmental Comm’n, eff. 11-8-93)

NAC 444.580 “Hazardous waste” defined. ([NRS 444.560](#)) “Hazardous waste” has the meaning ascribed to it in [NRS 459.430](#).

[Environmental Comm’n, Solid Waste Mgt Reg. § 1.5, eff. 9-21-77]—(NAC A 9-2-92)

NAC 444.581 “Household waste” defined. ([NRS 444.560](#)) “Household waste” means any solid waste, including garbage, trash and sanitary wastes, derived from households, including single and multiple family residences, hotels, motels, bunkhouses, ranger stations, crew quarters, campgrounds, picnic grounds and recreation areas used during the daytime.

(Added to NAC by Environmental Comm’n, eff. 11-8-93)

NAC 444.584 “Incinerator” defined. ([NRS 444.560](#)) “Incinerator” means an engineered apparatus capable of withstanding heat and designed to efficiently reduce solid, semi-solid, liquid or gaseous waste at specified rates, and from which the residues contain little or no combustible material.

[Environmental Comm’n, Solid Waste Mgt Reg. § 1.7, eff. 9-21-77]

NAC 444.585 “Industrial solid waste” defined. ([NRS 444.560](#))

1. “Industrial solid waste” means solid waste derived from industrial or manufacturing processes, including, but not limited to, the solid waste generated by the:

- (a) Generation of electric power;
- (b) Manufacture of fertilizer and agricultural chemicals;
- (c) Manufacture of food and its related products and by-products;
- (d) Manufacture of inorganic chemicals;
- (e) Manufacture of leather and products made from leather;
- (f) Manufacture of nonferrous metals, including the foundries which manufacture those metals;
- (g) Manufacture of organic chemicals;
- (h) Manufacture of plastics, resins and other miscellaneous products made from plastic;
- (i) Pulp and paper industry;
- (j) Manufacture of rubber and other miscellaneous products made from rubber;
- (k) Manufacture of products made from stone, glass, clay and concrete;
- (l) Manufacture of textiles;
- (m) Manufacture of transportation equipment;
- (n) Treatment of water;
- (o) Manufacture of iron and steel; and
- (p) Construction, refurbishing or demolition of buildings or other structures.

2. The term does not include waste generated by the mining, oil and gas industries.

(Added to NAC by Environmental Comm'n, eff. 9-2-92; A 11-8-93)

NAC 444.587 “Lateral expansion” defined. ([NRS 444.560](#)) “Lateral expansion” means a horizontal expansion of the waste boundaries of a disposal site after October 9, 1993.

(Added to NAC by Environmental Comm'n, eff. 9-2-92)

NAC 444.5875 “Leachate” defined. ([NRS 444.560](#)) “Leachate” means a liquid which has passed through or emerged from a municipal solid waste landfill unit and contains soluble, suspended or miscible materials removed from the waste within the unit.

(Added to NAC by Environmental Comm'n, eff. 11-8-93)

NAC 444.588 “Lift” defined. ([NRS 444.560](#)) “Lift” means a compacted layer of solid waste, typically consisting of several cells, which is approximately 10 to 15 feet thick, placed within a defined area of a municipal solid waste landfill unit and separated from other lifts on the top and bottom by a layer of cover material.

[Environmental Comm'n, Solid Waste Mgt Reg. § 1.9, eff. 9-21-77]—(NAC A 11-8-93)

NAC 444.589 “Medical waste” defined. ([NRS 444.560](#)) “Medical waste” has the meaning as ascribed to it in 49 C.F.R. Part 173, Appendix G - “Definition of Regulated Medical Waste,” as that Appendix existed on November 8, 1993.

(Added to NAC by Environmental Comm'n, eff. 11-8-93)

NAC 444.591 “Municipal solid waste landfill unit” defined. ([NRS 444.560](#)) “Municipal solid waste landfill unit” means a discrete area of land or an excavation that receives household waste. A municipal solid waste landfill unit may receive other types of solid waste, including sludge and industrial solid waste. A municipal solid waste landfill unit may be publicly or privately owned. The term does not include an injection well, a surface impoundment, a land application unit or a waste pile, as those terms are defined in 40 C.F.R. § 257.2.

(Added to NAC by Environmental Comm'n, eff. 9-2-92; A 11-8-93; 3-1-94)

NAC 444.592 “Municipality” defined. ([NRS 444.560](#)) “Municipality” means any county and any city or town, whether incorporated or unincorporated, and Carson City.

[Environmental Comm'n, Solid Waste Mgt Reg. § 1.11, eff. 9-21-77]

NAC 444.593 “New municipal solid waste landfill unit” defined. ([NRS 444.560](#)) “New municipal solid waste landfill unit” means a municipal solid waste landfill unit which has not received waste before November 8, 1993.

(Added to NAC by Environmental Comm'n, eff. 11-8-93)

NAC 444.594 “Nuisance” defined. ([NRS 444.560](#)) “Nuisance” means anything which is injurious to health, offensive to the senses, or an obstruction to the free use of property, and thus interferes with the comfortable enjoyment of life or property.

[Environmental Comm'n, Solid Waste Mgt Reg. § 1.12, eff. 9-21-77]

NAC 444.596 “Open burning” defined. ([NRS 444.560](#)) “Open burning” means the combustion of solid waste without:

1. The control of air to maintain an adequate temperature for efficient combustion;
2. The containment of the reaction in an enclosed device to provide sufficient residence time and mixing for a complete combustion; and
3. The control of the emission of the products resulting from the combustion.

[Environmental Comm'n, Solid Waste Mgt Reg. § 1.13, eff. 9-21-77]—(NAC A 11-8-93)

NAC 444.598 “Open dump” defined. ([NRS 444.560](#)) “Open dump” means an uncontrolled disposal site where solid waste is disposed of in a manner which does not comply with [NRS 444.630](#), [NAC 444.570](#) to [444.7499](#), inclusive, or any permit issued pursuant thereto.

[Environmental Comm’n, Solid Waste Mgt Reg. § 1.14, eff. 9-21-77]—(NAC A 11-8-93; 3-1-94)

NAC 444.5985 “Operator” defined. ([NRS 444.560](#)) “Operator” means the person responsible for the overall operation of a disposal site or any part of that site.

(Added to NAC by Environmental Comm’n, eff. 11-8-93)

NAC 444.599 “Owner” defined. ([NRS 444.560](#)) “Owner” means the person who owns a disposal site or any part of that site.

(Added to NAC by Environmental Comm’n, eff. 11-8-93)

NAC 444.600 “Pathological wastes” defined. ([NRS 444.560](#)) “Pathological wastes” means human and animal remains, consisting of carcasses, organs and solid organic waste from hospitals, laboratories, abattoirs, animal pounds and similar sources.

[Environmental Comm’n, Solid Waste Mgt Reg. § 1.15, eff. 9-21-77]

NAC 444.602 “Percolation” defined. ([NRS 444.560](#)) “Percolation” means the downward movement of water through soil or waste.

[Environmental Comm’n, Solid Waste Mgt Reg. § 1.16, eff. 9-21-77]

NAC 444.604 “Person” defined. ([NRS 444.560](#)) “Person” includes any state or federal agency, any state, including the State of Nevada, a political subdivision of any state, including the State of Nevada, and an interstate agency or organization.

[Environmental Comm’n, Solid Waste Mgt Reg. § 1.17, eff. 9-21-77]—(NAC A 11-8-93)

NAC 444.605 “Pollutant” defined. ([NRS 444.560](#)) “Pollutant” has the meaning ascribed to it in [NRS 445A.400](#).

(Added to NAC by Environmental Comm’n, eff. 9-2-92)

NAC 444.6065 “Postclosure” defined. ([NRS 444.560](#)) “Postclosure” means the period immediately after a disposal site is closed which lasts in accordance with [NAC 444.6894](#).

(Added to NAC by Environmental Comm’n, eff. 11-8-93)

NAC 444.607 “Public waste storage bin facility” defined. ([NRS 444.560](#)) “Public waste storage bin facility” means a facility that provides one or more portable waste containers which are used for the collection of solid waste for transport to a solid waste disposal site. The term does not include residential or commercial waste containers that are located on or near a site of waste generation.

(Added to NAC by Environmental Comm’n by R034-98, eff. 4-17-98; A by R105-02, 10-18-2002)

NAC 444.608 “Putrescible” defined. ([NRS 444.560](#)) “Putrescible” means capable of being decomposed by microorganisms with sufficient rapidity as to cause nuisances from odors or gases.

[Environmental Comm’n, Solid Waste Mgt Reg. § 1.19, eff. 9-21-77]

NAC 444.609 “Qualified groundwater scientist” defined. ([NRS 444.560](#)) “Qualified groundwater scientist” means a person who has received a baccalaureate or postgraduate degree in the natural sciences or engineering and has sufficient training and experience in groundwater hydrology and related fields as may be demonstrated by professional certifications or the completion of accredited programs offered by a college or university which enable him or her to make sound professional judgments regarding the monitoring of groundwater, the fate and transportation of contaminants, and required corrective actions.

(Added to NAC by Environmental Comm’n, eff. 11-8-93)

NAC 444.610 “Refuse” defined. ([NRS 444.560](#))

1. “Refuse” means any:

- (a) Garbage.
- (b) Sludge from a:
 - (1) Plant that treats wastewater.
 - (2) Plant that treats the water supply.
 - (3) Facility for controlling air pollution.
- (c) Other discarded material, including solid, semi-solid, liquid or contained gaseous material, resulting from industrial or commercial operations or community activities.

2. The term does not include:

- (a) Any discarded material, including solid, semi-solid, liquid or contained gaseous material, resulting from mining or agricultural activities which is excluded from a plan for a system for the management of solid waste pursuant to [NRS 444.620](#).
 - (b) Solid or dissolved materials in domestic sewage.
 - (c) Industrial discharges that are point sources subject to [NRS 445A.465](#).
 - (d) Source material, special nuclear material or by-product material, as those terms are defined by the Atomic Energy Act of 1954, as that act existed on November 8, 1993.
- [Environmental Comm’n, Solid Waste Mgt Reg. § 1.20, eff. 9-21-77]—(NAC A 11-8-93)

NAC 444.612 “Rubbish” defined. ([NRS 444.560](#)) “Rubbish” means nonputrescible solid waste, consisting of both combustible and noncombustible wastes such as paper, cardboard, abandoned automobiles, tin cans, wood, glass, bedding, crockery and similar materials.

[Environmental Comm’n, Solid Waste Mgt Reg. § 1.21, eff. 9-21-77]

NAC 444.614 “Salvage yard” defined. ([NRS 444.560](#)) “Salvage yard” means any place where salvaged material is regularly dismantled, accumulated, stored or offered for sale, unless such operations are wholly contained in an approved building.

[Environmental Comm’n, Solid Waste Mgt Reg. § 1.23, eff. 9-21-77]

NAC 444.616 “Salvaging” defined. ([NRS 444.560](#)) “Salvaging” means the controlled removal of material from the solid waste stream for reuse, sale or recycling.

[Environmental Comm’n, Solid Waste Mgt Reg. § 1.22, eff. 9-21-77]

NAC 444.620 “Scavenging” defined. ([NRS 444.560](#)) “Scavenging” means the uncontrolled removal of material from the solid waste stream for any purpose in a manner which interferes with the safe, efficient operation of the system.

[Environmental Comm’n, Solid Waste Mgt Reg. § 1.25, eff. 9-21-77]

NAC 444.622 “Solid waste” defined. ([NRS 444.560](#)) “Solid waste” has the meaning ascribed to it in [NRS 444.490](#).

[Environmental Comm’n, Solid Waste Mgt Reg. § 1.26, eff. 9-21-77]—(NAC A 11-8-93)

NAC 444.624 “Solid waste management authority” defined. ([NRS 444.560](#)) “Solid waste management authority” has the meaning ascribed to it in [NRS 444.495](#).

[Environmental Comm’n, Solid Waste Mgt Reg. § 1.27, eff. 9-21-77]—(NAC A 11-8-93)

NAC 444.626 “Solid waste management system” defined. ([NRS 444.560](#)) “Solid waste management system” means the entire process of storage, collection, transportation, processing and disposal of solid waste by any person engaging in such process as a business or by any municipality or by any combination thereof.

[Environmental Comm’n, Solid Waste Mgt Reg. § 1.28, eff. 9-21-77]

NAC 444.6265 “Surface impoundment” defined. ([NRS 444.560](#)) “Surface impoundment” means a

facility or part of a facility which is a natural topographic depression, artificially created excavation or diked area formed primarily of earthen material or lined with artificially created material, which is designed to hold an accumulation of liquid wastes or wastes containing free liquids. The term includes holding storage, settling and aeration pits, ponds and lagoons. The term does not include an injection well.

(Added to NAC by Environmental Comm'n, eff. 11-8-93)

NAC 444.628 "Transfer station" defined. ([NRS 444.560](#)) "Transfer station" means a solid waste processing site where solid waste is transferred from one vehicle to another vehicle or storage device for temporary storage until transferred to a disposal site. Some processing may be included therein. The term does not include public waste storage bin facilities.

[Environmental Comm'n, Solid Waste Mgt Reg. § 1.29, eff. 9-21-77]—(NAC A by R034-98, 4-17-98; R105-02, 10-18-2002)

NAC 444.629 "Uppermost aquifer" defined. ([NRS 444.560](#)) "Uppermost aquifer" means the aquifer located within the boundaries of a disposal site that is nearest the natural ground surface. The term includes lower aquifers which are hydraulically interconnected within the boundary of the disposal site.

(Added to NAC by Environmental Comm'n, eff. 11-8-93)

NAC 444.630 "Vector" defined. ([NRS 444.560](#)) "Vector" means a living insect or other arthropod or animal (not human) capable of carrying infectious disease from one person or animal to another.

[Environmental Comm'n, Solid Waste Mgt Reg. § 1.30, eff. 9-21-77]

NAC 444.631 "Waters of the State" defined. ([NRS 444.560](#)) "Waters of the State" has the meaning ascribed to it in [NRS 445A.415](#).

(Added to NAC by Environmental Comm'n, eff. 9-2-92)

NAC 444.634 Severability. ([NRS 444.560](#)) If any of the provisions of [NAC 444.570](#) to [444.7499](#), inclusive, or any application thereof to any person, thing or circumstance is held invalid, it is intended that such invalidity not affect the remaining provisions, or their application, that can be given effect without the invalid provision or application.

[Environmental Comm'n, Solid Waste Mgt Reg. § 2.1.1, eff. 9-21-77]—(NAC A 11-8-93; 3-1-94; R173-99, 2-9-2000)

NAC 444.636 Adoption by reference of certain provisions of Code of Federal Regulations, United States Geological Survey and Environmental Protection Agency. ([NRS 444.560](#))

1. The following provisions are hereby adopted by reference:

(a) Appendix I to 40 C.F.R. Part 258, as that Appendix existed on November 8, 1993;

(b) Appendix II to 40 C.F.R. Part 258, as that Appendix existed on November 8, 1993;

(c) The provisions of 40 C.F.R. Part 257.2, as that part existed on November 8, 1993, for the limited purposes of defining "municipal solid waste landfill unit" in [NAC 444.591](#);

(d) The United States Geological Survey, Open File Report 82-1033, "Probabilistic Estimates of Maximum Acceleration and Velocity in Rock in the Contiguous United States," for the limited purpose of defining "seismic impact zone" in [NAC 444.6793](#);

(e) "Test Methods for Evaluating Solid Waste, Physical/Chemical Methods," Environmental Protection Agency, Publication No. SW-846, for the limited purposes of defining "liquid waste" in [NAC 444.692](#); and

(f) The Toxic Substances Control Act Good Laboratory Practice Standards, 40 C.F.R. Part 792, as those standards existed on March 1, 1994, for the limited purpose of conducting scientific studies pursuant to subparagraph (II) of subparagraph (2) of paragraph (b) of subsection 1 of [NAC 444.7492](#).

2. Volume 40 C.F.R. Parts 190 to 259, inclusive, may be obtained by mail from the Superintendent of Documents, U.S. Government Printing Office, P.O. Box 979050, St. Louis, Missouri 63197-9000, or by toll-free telephone at (866) 512-1800, for the price of \$22.

3. The report of the United States Geological Survey may be obtained from the United States Geological

Survey, Books and Open Files Reports Section, Federal Center, Building 810, Box 25425, Denver, Colorado 80225, at a cost of \$24.50.

4. Publication No. SW-846 of the Environmental Protection Agency may be obtained from NTIS, United States Department of Commerce, Springfield, Virginia 22161, at a cost of \$243.

5. The Toxic Substances Control Act Good Laboratory Practice Standards, 40 C.F.R. Part 792, may be obtained by mail from the Superintendent of Documents, U.S. Government Printing Office, P.O. Box 979050, St. Louis, Missouri 63197-9000, or by toll-free telephone at (866) 512-1800, for the price of \$19.

(Added to NAC by Environmental Comm'n, eff. 9-2-92; A 11-8-93; 3-1-94; R202-97, 3-5-98)

NAC 444.638 Interpretation of provisions. (NRS 444.560)

1. The provisions of [NAC 444.570](#) to [444.7499](#), inclusive, may not be interpreted to circumvent any of those provisions to make them less effective.

2. If more than one interpretation exists for a provision, the more restrictive interpretation applies.

[Environmental Comm'n, Solid Waste Mgt Reg. §§ 2.2.1 & 2.2.2, eff. 9-21-77]—(NAC A 11-8-93; 3-1-94; R173-99, 2-9-2000)

NAC 444.639 Interrelation with other laws and regulations. (NRS 444.560) The provisions of [NAC 444.570](#) to [444.7499](#), inclusive, do not waive or circumvent the provisions of [NRS 445A.300](#) to [445A.730](#), inclusive, [445B.100](#) to [445B.640](#), inclusive, [459.400](#) to [459.600](#), inclusive, and [459.800](#) to [459.856](#), inclusive. Each owner and operator shall comply with all other laws and regulations adopted and orders issued pursuant to those sections governing the disposal of solid waste.

(Added to NAC by Environmental Comm'n, eff. 11-8-93; A 3-1-94; R173-99, 2-9-2000)

Provisions Applicable to Solid Waste Management Systems

NAC 444.640 Open burning; disposal of animal carcasses. (NRS 444.560)

1. Except as otherwise provided in this section, open burning of solid wastes at a disposal site, transfer station or other facility which handles solid waste is prohibited.

2. The solid waste management authority may approve open burning of yard waste and other untreated wood waste at facilities that serve remote communities if:

(a) There is no other practicable alternative for the management of the waste; and

(b) The burning is done in accordance with [NAC 445B.22067](#).

3. The provisions of [NAC 444.570](#) to [444.7499](#), inclusive, do not prevent the disposal of animal carcasses by burning if such burning is done in accordance with [NAC 445B.22067](#), except that such burning is not allowed at municipal solid waste landfill units and Class III sites covered by those provisions.

[Environmental Comm'n, Solid Waste Mgt Reg. §§ 2.3.1 & 2.3.2, eff. 9-21-77]—(NAC A 11-8-93; 3-1-94; R105-02, 10-18-2002)

NAC 444.6405 Permit to operate disposal site: Requirement; exemptions; application. (NRS 444.560)

1. Except as otherwise provided in subsection 2, the owner or operator of a disposal site must obtain a permit to operate the site from the appropriate solid waste management authority.

2. The following sites are exempt from the provisions of subsection 1:

(a) Composting bins which are operated at a personal residence for personal use; and

(b) Municipal composting operations for yard wastes.

3. The owner or operator of a proposed disposal site must obtain the permit before the construction or operation of that site. An application for the permit must be submitted at least 180 days before the anticipated start of construction, to allow sufficient time for the review and issuance of the permit.

(Added to NAC by Environmental Comm'n, eff. 11-8-93; A 11-9-95; 10-3-96; R105-02, 10-18-2002)

NAC 444.641 Permit to operate disposal site: Evaluation of application; notice to applicant concerning completeness and compliance; notice of intent to issue or deny application; period for public comment. (NRS 444.560)

1. A solid waste management authority shall, within 45 days after receiving an application for a permit to operate a disposal site, notify the applicant as to whether the application is complete or deficient in content. A determination of completeness must be based on whether the application contains all specified documents and supporting information required by [NAC 444.677](#), [444.705](#) or [444.733](#), as applicable. The solid waste management authority may require the submittal of any such additional documents or information as it deems necessary and may specify the period within which the documents or information must be submitted to the authority.

2. If the solid waste management authority determines that an application is complete, the authority shall evaluate the merits of the application to determine if the application is in compliance with all applicable statutes and regulations. If the solid waste management authority determines that the application does not comply with all applicable statutes and regulations, it shall mail a notice to the applicant. The notice must specify:

- (a) Each statute or regulation with which the applicant has failed to comply;
- (b) Any documents or other information which the applicant is required to submit to the authority; and
- (c) The period within which the applicant is required to submit to the authority the documents or other information requested pursuant to paragraph (b).

3. Upon completion of the evaluation, the solid waste management authority shall prepare and issue:

- (a) A notice of intent to issue or deny the issuance of the permit. The notice must:
 - (1) Be sent to the applicant and the local governing body in the area in which the disposal site is to be located, and published in a newspaper of general circulation for the area in which the site is located;
 - (2) Summarize the action to be taken by the solid waste management authority;
 - (3) State that the authority will accept comments from the general public for 30 days after the date that the notice is issued; and
 - (4) Describe the procedure for obtaining copies of the documents and comments submitted with the application.

(b) A factual sheet which describes the proposed facility, the proposed action, the availability of the documents submitted with the application, and the procedure for public review and comment.

(Added to NAC by Environmental Comm'n, eff. 11-8-93; A 10-3-96)

NAC 444.6415 Permit to operate disposal site: Response to notice of intent to issue or deny application; request for public hearing; notice of public hearing. ([NRS 444.560](#))

1. An applicant for a permit to operate a disposal site and any other interested person may, within 30 days after the notice of intent is issued pursuant to [NAC 444.641](#):

(a) Submit a written request to the solid waste management authority for a public hearing on the proposed issuance or denial of the permit which must state the nature of the issues which the requester intends to raise at the hearing; or

(b) Submit written comments on the proposed issuance or denial of the permit to the solid waste management authority.

2. The solid waste management authority:

- (a) May schedule a public hearing if requested pursuant to this section or on its own initiative; and
- (b) Shall publish a notice of a hearing scheduled pursuant to this section at least 30 days before the date of that hearing.

3. The solid waste management authority may extend the period for public review as it deems necessary.

(Added to NAC by Environmental Comm'n, eff. 11-8-93)

NAC 444.6419 Permit to operate disposal site: Response by solid waste management authority to written comments concerning proposed issuance or denial of permit; publication of written comments. ([NRS 444.560](#))

The solid waste management authority shall issue a statement responding to the written comments on the proposed issuance or denial of a permit to operate a disposal site which are received during the period for public review. A copy of the statement must be sent to the applicant, the person who submitted the written comments, if different from the applicant, and all other persons who specifically request, in writing, a copy of the statement. A copy of the statement must be made available for inspection by the general public at a location specified by the solid waste management authority.

(Added to NAC by Environmental Comm'n, eff. 11-8-93)

NAC 444.6425 Permit to operate disposal site: Duties of solid waste management authority after period for public review; modification or placement of conditions based on public comments. (NRS 444.560)

1. Within 30 days after the end of the period for public review, the solid waste management authority shall:

(a) Issue a permit to operate a disposal site; or

(b) Deny the application and send written notice to the applicant which details the reasons why the application is being denied. The written notice must set forth the time and procedure by which the applicant may appeal the decision of the solid waste management authority.

2. The solid waste management authority may modify or place conditions on a permit issued pursuant to this section based on public comments received concerning the permit.

(Added to NAC by Environmental Comm'n, eff. 11-8-93; A by R105-02, 10-18-2002)

NAC 444.643 Permit to operate disposal site: Issuance; revocation or suspension; requirements for transfer to subsequent owner or operator. (NRS 444.560) A permit to operate a disposal site issued by a solid waste management authority:

1. Must be issued for the life of the design of the disposal site;

2. May be modified by the solid waste management authority if the statutes or regulations upon which the issuance of the permit is based change, or if a modification is otherwise necessary to protect public health and safety and the environment;

3. Must specify the amount and type of solid waste which the disposal site may receive that is consistent with the design and operational plans of the site;

4. Must be issued for the area and volume of waste specified in the application, if the disposal site is a municipal solid waste landfill unit or Class III site;

5. May be revoked or suspended if written notice is given by the solid waste management authority and the disposal site does not remain in compliance with the applicable statutes and regulations; and

6. Must be issued to a specific operator or owner. A permit may be transferred to a subsequent owner or operator only if the solid waste management authority approves the transfer based on documentation of financial responsibility provided by the new owner or operator.

(Added to NAC by Environmental Comm'n, eff. 11-8-93)

NAC 444.6435 Permit to operate disposal site: Request for modification; conditions requiring public notice and review. (NRS 444.560) A permit to operate a disposal site may be modified upon the request of the owner or operator of the disposal site and approval of the solid waste management authority. A proposal to modify a permit may be subject to public notice and 30 days of public review if the proposed modification includes:

1. An increase in the amount or type of solid wastes managed at the site which is inconsistent with the permitted design, operational plans or municipal plans concerning the management of solid waste;

2. A change in the manner of waste management at the site which is inconsistent with the permitted design or operational plans of the site;

3. A substantive change in the:

(a) Permitted design of the site;

(b) Plans for closure and postclosure;

(c) Procedures for monitoring the site and for taking any necessary corrective actions; or

(d) The mechanisms for financial assurance; and

4. Any other change which is deemed by the solid waste management authority to require public notice and a public hearing.

(Added to NAC by Environmental Comm'n, eff. 11-8-93)

NAC 444.644 Systems for solid waste. (NRS 444.560)

1. All solid wastes must be:
 - (a) Stored, collected, utilized, treated, processed and disposed of by means that do not create a health hazard, public nuisance or impairment of the environment.
 - (b) Handled in such a manner which does not contribute to breeding of insects and rodents or to support any disease vector.
2. All solid waste systems must be operated in a manner that will not cause or contribute to pollution of:
 - (a) The atmosphere; or
 - (b) Surface or groundwaters of the State.
3. No system for solid waste handling, processing, salvage or disposal may be placed in operation unless approved by the solid waste management authority.
 [Environmental Comm'n, Solid Waste Mgt Reg. §§ 2.5.1-2.5.5, eff. 9-21-77]—(NAC A 9-2-92)

NAC 444.645 Program for quality assurance and control for construction of required liner system. ([NRS 444.560](#)) The owner or operator of a municipal solid waste landfill unit shall:

1. Develop and carry out a program for quality assurance and quality control for the construction of all liner systems required by [NAC 444.681](#); and
2. Submit a summary of this program to the solid waste management authority before waste may be placed in the municipal solid waste landfill unit.
 (Added to NAC by Environmental Comm'n, eff. 11-8-93)

NAC 444.646 Disposal of special wastes: Sewage sludge, septic tank pumpings and medical wastes; coverage of burial area. ([NRS 444.560](#))

1. Sewage sludges, septic tank pumpings and medical wastes may be deposited at a disposal site only if provisions for such disposal are included in the operational plan and approved by the solid waste management authority.
2. A completed special waste burial area must be covered with a layer of suitable cover material compacted to a minimum uniform depth of 36 inches.
 [Environmental Comm'n, Solid Waste Mgt Reg. §§ 2.6.1.1-2.6.1.3, eff. 9-21-77]—(NAC A 9-2-92; 11-8-93)

NAC 444.648 Disposal of special wastes: Waste tires. ([NRS 444.560](#))

1. Disposal of waste tires by open dumping is prohibited.
2. Disposal of waste tires by open burning is prohibited.
3. Waste tires which are disposed of by landfilling and which are not incorporated with other wastes in a landfill for which a permit has been issued by a solid waste management authority pursuant to [NAC 444.6405](#) must be chipped, split or otherwise handled in a manner approved by the solid waste management authority which:
 - (a) Prevents tires from resurfacing after they have been covered;
 - (b) Reduces the possibility of a fire at the landfill;
 - (c) Controls vectors; and
 - (d) Otherwise protects the environment and public health.
 [Environmental Comm'n, Solid Waste Mgt Reg. §§ 2.6.2.1-2.6.2.4, eff. 9-21-77]—(NAC A 12-15-94)

NAC 444.650 Disposal of special wastes: Waste oils. ([NRS 444.560](#))

1. Large quantities of waste oils, greases, oil sludges or oil soaked wastes must not be placed in any land disposal site unless special provisions for handling and other special precautions are included in the operational plan to prevent fires and pollution of surface or groundwaters.
2. Provisions for handling and disposing of large quantities of waste oils are effective only if approved by the solid waste management authority.
 [Environmental Comm'n, Solid Waste Mgt Reg. §§ 2.6.3.1-2.6.3.2, eff. 9-21-77]

NAC 444.652 Disposal of special wastes: Construction and demolition wastes. ([NRS](#)

444.560 Landfills incorporating large quantities of construction and demolition wastes of combustible nature must be cross-sectioned into cells by compacted cover material to prevent spread of accidental fires.
[Environmental Comm'n, Solid Waste Mgt Reg. § 2.6.4.1, eff. 9-21-77]

NAC 444.654 Disposal of special wastes: Septic tank pumpings and raw sewage. (NRS 444.560)

1. Septic tank pumpings and raw sewage must not be disposed of by land spreading, unless it is specifically determined and approved in writing by the solid waste management authority that such disposal can be conducted with assured, adequate protection of public health and safety and the environment.

2. The disposal of raw sewage and the septic tank pumpings at a municipal solid waste landfill unit or a Class III site are prohibited.

[Environmental Comm'n, Solid Waste Mgt Reg. § 2.6.5.1, eff. 9-21-77]—(NAC A 11-8-93)

NAC 444.656 Disposal of special wastes: Untreated sewage sludge. (NRS 444.560) Untreated sewage sludges must not be:

1. Used as fertilizer on root crops, vegetables, low-growing berries or fruits that may be eaten raw.

2. Applied to land later than 1 year prior to planting, where vegetables are to be grown.

3. Used on grass in public parks or other areas at a time or in such a way that people could unknowingly come in contact with it.

4. Given or sold to the public without their knowledge as to its origin.

[Environmental Comm'n, Solid Waste Mgt Reg. §§ 2.6.5.2.1-2.6.5.2.4, eff. 9-21-77]

NAC 444.658 Plans to manage solid waste. (NRS 444.560)

1. Every municipality or district board of health must develop a plan for the management of solid waste within the area of its jurisdiction, together with a program for carrying out the plan.

2. The area or region to be included in such plan is the area within the boundaries of each county in the State, except in those instances where an incorporated city develops and carries out a separate plan. This section does not prevent several municipalities from developing a single combined plan.

3. Such plans must be comprehensive in scope so as to provide for all parts of a complete solid waste management system.

4. In those areas where plans for a solid waste management system have already been developed and approved, plans must be updated as necessary to conform with NAC 444.570 to 444.7499, inclusive, and submitted to the Division. The updated plan may be in the form of a letter or summary if all necessary items are included.

5. The schedule for carrying out the plan must state the times for putting each part of the plan into effect.

6. All municipalities and district boards of health must submit their respective plans for a solid waste management system on or before October 1, 1994.

7. Every plan must be reviewed and updated as necessary, but not less often than once every 5 years following October 1, 1994.

8. Every plan must be submitted to the Division for its approval. The plan may not be carried out unless it has been approved by the Division.

[Environmental Comm'n, Solid Waste Mgt Reg. §§ 2.7.1-2.7.7, eff. 9-21-77]—(NAC A 9-2-92; 11-8-93; 3-1-94)

NAC 444.660 Standards for storage, collection and transportation set by ordinances. (NRS 444.560)

1. The storage on the premises, the collection and the transportation to the disposal site of solid waste must generally be according to the pertinent ordinances or regulations of the city, town or county wherein those services are performed.

2. The provisions of NAC 444.570 to 444.7499, inclusive, do not abridge the authority of a town, city or county to establish, by ordinance or otherwise, higher standards than those contained in those sections.

3. No system for the storage, collection or transportation of solid waste may be allowed to cause health hazards, public nuisances or otherwise cause or contribute to the impairment of the environment.

[Environmental Comm'n, Solid Waste Mgt Reg. §§ 3.1 & 3.2, eff. 9-21-77]—(NAC A 11-8-93; 3-1-94)

NAC 444.662 Storage of solid wastes before collection. ([NRS 444.560](#))

1. The owner or occupant, or both, of any premises, business establishment or industry are responsible for the safe and sanitary storage of all solid waste accumulated at the premise until it is removed.
2. All garbage and similar putrescible waste:
 - (a) Must be stored in:
 - (1) Durable, nonabsorbent, watertight and easily cleanable containers that are resistant to corrosion and rodents. The covers of such containers must prevent the entry of flies.
 - (2) Other types of containers acceptable to the solid waste management authority which conform to the intent of [NAC 444.660](#) to [444.666](#), inclusive.
 - (b) Except as otherwise provided in subsection 5, must not be stored for more than 1 week before collection.
3. The size and allowable weight of the container must be determined by the collection agency, subject to the approval of the solid waste management authority.
4. If garbage and similar putrescible wastes are stored in combination with nonputrescible wastes, containers for the storage of the mixture must meet the requirements for garbage storage.
5. The solid waste management authority may approve the storage of garbage and similar putrescible wastes for more than 1 week before collection in a remote community if the municipality in whose jurisdiction the storage occurs demonstrates that an alternative minimum collection frequency will not result in increased litter or odors, the harboring of vectors, the storage of excess waste outside of containers, or any other health hazard, public nuisance or impairment to the environment. The solid waste management authority may revoke its approval of an alternative minimum collection frequency.
6. Medical wastes must be stored in watertight, tightly covered and clearly labeled containers that are resistant to corrosion and are in a safe location, inaccessible to the public. In addition, medical wastes must be stored in cleanable containers with liners or in a manner approved by the solid waste management authority. Medical wastes must not be deposited in containers with other solid wastes. Medical wastes must be transported separately from other solid wastes to an approved disposal site and handled in accordance with a method approved by the solid waste management authority.
7. Bulky wastes or other nonputrescible wastes unsuitable for storage containers must be stored in a manner that does not cause a nuisance.

[Environmental Comm'n, Solid Waste Mgt Reg. §§ 3.3.1-3.3.5, eff. 9-21-77]—(NAC A 11-8-93; R105-02, 10-18-2002)

NAC 444.664 Collection and transportation of solid wastes. ([NRS 444.560](#))

1. The owner or occupant, or both, of any premises, business establishment or industry are responsible for the satisfactory and legal arrangement for removal of all solid waste accumulated at the premises.
2. The person collecting or transporting solid waste is responsible for prevention of littering and creation of other nuisances at the loading point and during transport, and for proper unloading at an authorized site or facility for solid waste disposal.
3. Vehicles or containers used for the collection and transportation of garbage and similar putrescible waste or refuse must be tightly covered, leak proof, durable and of easily cleanable construction. The vehicles or containers must be cleaned frequently to prevent nuisances and insect breeding and must be maintained in good repair.
4. Vehicles or containers used for the collection and transportation of any solid waste must be loaded and moved in such a manner that the contents will not fall, leak or spill therefrom and must be covered as necessary to prevent the blowing of material from the vehicle or container. Where spillage does occur, the waste must be picked up immediately by the collector or transporter and returned to the vehicle or container and the area otherwise properly cleaned.

[Environmental Comm'n, Solid Waste Mgt Reg. §§ 3.4.1-3.4.4, eff. 9-21-77]

NAC 444.666 Transfer stations: Design and operating plans. ([NRS 444.560](#))

1. A transfer station must not be established until the site location and the design and operating plans of

the transfer station have been approved by the solid waste management authority.

2. A transfer station must be designed and constructed so as to be esthetically compatible with its environs.

[Environmental Comm'n, Solid Waste Mgt Reg. §§ 3.5.1-3.5.3, eff. 9-21-77]—(NAC A by R034-98, 4-17-98)

NAC 444.6661 Transfer stations: Application to operate or modify. (NRS 444.560)

1. An application to operate a new transfer station or to modify an existing transfer station must be submitted to the solid waste management authority before construction commences.

2. The application must include:

(a) The name, location and mailing address of:

- (1) The transfer station;
- (2) The owner of the transfer station;
- (3) The operator of the transfer station; and
- (4) The authorized agent of the owner;

(b) Evidence of ownership of the land on which the transfer station will be located;

(c) The report concerning the design of the transfer station, as described in [NAC 444.6662](#);

(d) The plan for operating the transfer station, as described in [NAC 444.6663](#);

(e) Evidence of approval to establish a transfer station from the applicable local government; and

(f) Any other information that the solid waste management authority requires.

(Added to NAC by Environmental Comm'n by R034-98, eff. 4-17-98)

NAC 444.6662 Transfer stations: Contents of report concerning design. (NRS 444.560) The report concerning the design of the transfer station required pursuant to [NAC 444.6661](#) must:

1. Be prepared under the direction of a licensed professional engineer.

2. Be signed and stamped by a professional engineer who is licensed in this State.

3. Include, without limitation, a general location map that shows land use and zoning within a 1-mile radius of the transfer station.

4. Include, without limitation, plans and specifications of the transfer station in sufficient detail to demonstrate compliance with the design standards set forth in [NAC 444.6664](#). The plans must:

(a) Be drawn to a scale of not more than 200 feet per inch and must include, without limitation, contour intervals of not more than 5 feet;

(b) Show existing and proposed contours;

(c) Show access roads and traffic routing inside of and around the transfer station;

(d) Include, without limitation, provisions for the control of surface water runoff and runoff and show grades, berms, dikes, swales and other devices used for drainage and control of surface water;

(e) Show fencing, equipment, shelter, employee facilities, waste handling areas and any other appurtenance;

(f) Include, without limitation, provisions for weighing and measuring incoming solid waste;

(g) Include, without limitation, provisions for controlling odors and dust as necessary to prevent a public nuisance;

(h) Define the population and area to be served by the transfer station;

(i) List the anticipated types, quantities and sources of solid waste to be received at the transfer station; and

(j) Provide evidence that the transfer station will be in compliance with the design standards set forth in [NAC 444.6664](#).

(Added to NAC by Environmental Comm'n by R034-98, eff. 4-17-98)

NAC 444.6663 Transfer stations: Requirements for operating plan. (NRS 444.560) The operating plan of the transfer station required pursuant to [NAC 444.6661](#) must include, without limitation:

1. Provisions for the control of access to the transfer station;

2. The number of attendants who will be at the transfer station during operating hours;

3. A list of the equipment and machinery that will be used at the transfer station;

4. Procedures for controlling vehicular traffic;
5. The types of wastes that the transfer station will not receive and a list of the facilities where such waste will be directed;
6. A program for detecting and preventing the disposal of regulated hazardous waste and polychlorinated biphenyl wastes;
7. Procedures for measuring or weighing incoming solid waste;
8. The proposed capacity and expected life of the transfer station;
9. The frequency and method of transfer of solid waste to a disposal site;
10. The maximum time that solid waste will be stored at the transfer station;
11. The location of waste storage areas at the transfer station;
12. The proposed operating hours;
13. A contingency plan that describes procedures for emergencies and alternate solid waste handling systems;
14. A plan approved by the local fire authority for the prevention and control of fires;
15. A plan for the management of special wastes that are proposed for acceptance at the facility; and
16. A description of how the transfer station will comply with the operating standards set forth in [NAC 444.66645](#).

(Added to NAC by Environmental Comm'n by R034-98, eff. 4-17-98)

NAC 444.6664 Transfer stations: Construction. ([NRS 444.560](#))

1. A transfer station must be constructed with:
 - (a) Any barriers and appurtenances necessary to control access to the station;
 - (b) An all-weather access road;
 - (c) Appurtenances to control litter; and
 - (d) Areas for processing, tipping, sorting and storing that:
 - (1) Are located within a covered enclosure with at least three sides; and
 - (2) Have a floor with a hard surface such as concrete or asphalt pavement and a drainage structure for the recovery of liquids.
2. The transfer station must be constructed to comply with the requirements regarding signs set forth in [NAC 444.690](#).

(Added to NAC by Environmental Comm'n by R034-98, eff. 4-17-98)

NAC 444.66645 Transfer stations: Handling and salvage of solid waste; maintenance of records; handling of asbestos; removal of remaining waste at final closure. ([NRS 444.560](#))

1. Any solid waste accepted at a transfer station must be:
 - (a) Transferred to a disposal site that has been issued a permit by the solid waste management authority;
 or
 - (b) Salvaged for reuse or recycling and thereafter promptly removed from the transfer station.
2. A transfer station must be kept in a neat and orderly condition. All residual wastes or other residual material must be promptly removed from the transfer station.
3. Any area that is used for tipping, handling or storing solid waste must be free of standing water. The drainage from the floor of such an area must be discharged into a sewer or its equivalent.
4. A person shall not salvage solid waste from a transfer station unless he or she:
 - (a) Is authorized by the solid waste management authority;
 - (b) Is supervised by the operator of the station;
 - (c) Stores the salvaged material in clearly identified containers or areas; and
 - (d) Maintains the salvaged material in a safe, sanitary and orderly manner.
5. The operator of the transfer station shall maintain accurate records of the operations of the station. The records must be furnished upon request to the solid waste management authority or be made available for inspection by the solid waste management authority at any reasonable time. The records must include, without limitation:
 - (a) A daily log of the quantity of solid waste received and transported;
 - (b) Instances in which the station rejected a waste load; and

(c) Any emergencies or unusual events.

6. Solid waste must be removed from a transfer station not more than 72 hours after acceptance unless the owner or operator is prevented from doing so because of an emergency such as a fire or flood. The owner or operator shall notify the solid waste management authority not more than 24 hours after an emergency that results in the storage of solid waste for more than 72 hours.

7. The acceptance, handling and transportation of asbestos waste must be conducted pursuant to [NAC 444.965](#) to [444.980](#), inclusive.

8. At the final closure of a transfer station, any remaining wastes must be removed to a disposal site that has been issued a permit by the solid waste management authority.

(Added to NAC by Environmental Comm'n by R034-98, eff. 4-17-98)

NAC 444.66647 Public waste storage bin facility: Notification of establishment; general requirements; final closure. ([NRS 444.560](#))

1. The owner of a public waste storage bin facility shall notify the solid waste management authority in writing not more than 30 days after establishing the facility. The notification must include, without limitation:

- (a) The location of the facility;
- (b) The owner of the facility;
- (c) The name and phone number of the authorized agent of the owner;
- (d) The capacity of the facility in cubic yards;
- (e) The types of solid waste the facility receives; and
- (f) The population and area to be served by the facility.

2. Waste storage bins may have a combined capacity of not more than 160 cubic yards and must be constructed of durable, watertight materials with a lid or screen on top that prevents the loss of materials during transport. Storage of solid waste outside of the waste storage bins is prohibited unless approved by the solid waste management authority.

3. Except as otherwise provided in this subsection, if garbage and similar putrescible waste is stored in combination with nonputrescible waste, the wastes must not be stored at the facility for more than 1 week. The solid waste management authority may approve the storage of such waste for more than 1 week before collection in a remote community if the municipality in whose jurisdiction the storage occurs demonstrates that an alternative minimum collection frequency will not result in increased litter or odors, the harboring of vectors, the storage of excess waste outside of containers, or any other health hazard, public nuisance or impairment to the environment. The solid waste management authority may revoke its approval of an alternative minimum collection frequency.

4. The owner of a public waste storage bin facility shall:

- (a) Provide access to the facility by an all-weather road;
- (b) Construct the facility in a manner that allows the public to deposit waste materials conveniently and safely in the public waste storage bin;
- (c) Service the facility as often as is necessary to ensure that there is adequate storage capacity at all times;
- (d) Provide for the inspection of the site at least weekly and collect all scattered papers and other lightweight debris;
- (e) Use fences and other appurtenances to prevent the scattering of papers and other lightweight debris; and
- (f) Comply with the requirements regarding signs set forth in [NAC 444.690](#).

5. At final closure, the owner or operator shall remove any remaining wastes to a proper facility and shall remove all waste storage bins.

(Added to NAC by Environmental Comm'n by R034-98, eff. 4-17-98; A by R105-02, 10-18-2002)

NAC 444.6665 Operating criteria: Program for detecting and preventing disposal of regulated hazardous waste and PCB wastes. ([NRS 444.560](#))

1. The owner or operator shall carry out a program at the municipal solid waste landfill unit for detecting and preventing the disposal of regulated hazardous waste and PCB wastes. The program must include, but is not limited to:

- (a) Random inspections of incoming loads;
- (b) Records of inspections;
- (c) Training persons employed at the unit to recognize regulated hazardous waste and PCB wastes;
- (d) Procedures for handling hazardous waste or PCB wastes found at the site; and
- (e) Notification of the solid waste management authority if hazardous waste or PCB wastes are discovered at the unit.

2. As used in this section:

(a) "Hazardous waste" includes those wastes described by 40 C.F.R. Part 261.3 which are not excluded by 40 C.F.R. Part 261.4(b) or generated by a conditionally exempt small quantity generator in accordance with 40 C.F.R. Part 261.5, as those sections existed on November 8, 1993.

(b) "PCB" has the meaning ascribed to it in 40 C.F.R. Part 761.3, as that section existed on November 8, 1993.

(Added to NAC by Environmental Comm'n, eff. 11-8-93)

NAC 444.667 Operating criteria: Control of explosive gas. ([NRS 444.560](#))

1. An owner or operator shall provide for the control of explosive gas at the municipal solid waste landfill unit in accordance with the provisions of this section.

2. The owner or operator shall ensure that:

(a) The concentration of methane gas generated at the unit does not exceed 25 percent of the lower explosive limit for methane in structures, excluding components for any system to control or recover the gas; and

(b) The concentration of methane gas does not exceed the lower explosive limit for methane at the boundary of the unit.

3. The owner or operator shall carry out a routine program for monitoring methane gas to ensure that the standards set forth in subsection 2 are met. Except as otherwise provided in subsection 4, the level of methane must be monitored at least quarterly each year. The type and frequency of monitoring must be determined based on the:

- (a) Conditions of the soil;
- (b) Hydrogeologic conditions surrounding the unit;
- (c) Hydraulic conditions surrounding the unit; and
- (d) Location of the structures and boundaries of the unit.

4. The solid waste management authority may, after public review and comment, allow the owner or operator of a Class II site to monitor the level of methane gas less frequently than one time each quarter. In deciding whether to allow such a deviation, the solid waste management authority shall consider:

- (a) The unique characteristics of small communities;
- (b) Climatic and hydrogeologic conditions; and
- (c) Whether allowing the deviation would have an adverse effect on human health or the environment.

5. If the owner or operator detects levels of methane gas exceeding the limits specified in paragraph (a) of subsection 2, he or she shall:

(a) Immediately take all necessary actions to ensure protection of public health and safety and notify the solid waste management authority;

(b) Except as otherwise provided in subsection 6, within 7 days after detection, place in the operating records for the unit the levels of methane gas detected and a description of the actions taken to protect public health and safety; and

(c) Except as otherwise provided in subsection 6, within 60 days after detection, carry out a plan for remediation for the releases of methane gas, place a copy of the plan in the operating records and notify the solid waste management authority that the plan has been carried out. The plan must describe the nature and extent of the problem and the proposed remedy.

6. The solid waste management authority may establish alternative schedules for demonstrating compliance with paragraphs (b) and (c) of subsection 5.

7. As used in this section, "lower explosive limit" means the lowest percent by volume of a mixture of explosive gases in air that will propagate a flame at 25°C and at atmospheric pressure.

(Added to NAC by Environmental Comm'n, eff. 11-8-93; A 3-1-94; R034-98, 4-17-98)

NAC 444.6675 Operating criteria: Compliance with state implementation plan; open burning of certain solid wastes prohibited. ([NRS 444.560](#))

1. An owner or operator shall ensure that the municipal solid waste landfill unit does not violate any applicable requirements developed by the state implementation plan, if any, approved or adopted by the Administrator of the Environmental Protection Agency pursuant to section 110 of the federal Clean Air Act, as amended, 42 U.S.C. § 7410, as that section existed on November 8, 1993, and [NRS 445B.100](#) to [445B.640](#), inclusive, and the regulations adopted pursuant thereto.

2. Open burning of solid waste, except for the infrequent burning of agricultural wastes, silvicultural wastes, debris from land clearing, diseased trees or debris from emergency clean-up operations, is prohibited at all municipal solid waste landfill units.

(Added to NAC by Environmental Comm'n, eff. 11-8-93)

NAC 444.6678 Operating criteria: Vector control. ([NRS 444.560](#)) An owner or operator shall prevent or control populations of disease vectors at the municipal solid waste landfill unit using techniques appropriate for the protection of public health and safety and the environment. Other than daily cover, appropriate techniques must be instituted whenever required by the solid waste management authority to minimize the transmission of disease.

(Added to NAC by Environmental Comm'n, eff. 11-8-93)

NAC 444.668 System to process waste: Hazards, nuisances and impairment of environment prohibited. ([NRS 444.560](#)) No solid waste processing system may be allowed to cause health hazards, public nuisances or otherwise cause or contribute to the impairment of the environment.

[Environmental Comm'n, Solid Waste Mgt Reg. § 4.1, eff. 9-21-77]

NAC 444.670 System to process waste: Compost plant. ([NRS 444.560](#))

1. A compost plant must not be established until the site location, design of the plant and proposed method of operation have been approved by the solid waste management authority and a permit to operate the compost plant has been issued in accordance with the requirements of [NAC 444.6405](#) to [444.6435](#), inclusive. An application for such a permit must include:

(a) A description of the materials to be composted, including a characterization of the waste sufficient to evaluate the potential for biological or chemical contaminant migration in the event of a release;

(b) A layout diagram of the plant showing property boundaries, fencing, roads, principal processing equipment, storage areas for stockpiles of incoming materials and intermediate and final products;

(c) A description of the equipment and personnel necessary to operate the plant;

(d) A description of the process, with a schematic diagram, that shows loading and unloading areas and traffic flow routing;

(e) The maximum inventory, by volume, of feed stocks, intermediate materials and products;

(f) Proposed product specifications and a program to verify conformance with the specifications;

(g) A program for monitoring the parameters of the process, including moisture content and temperature;

(h) A description of the final use for the compost or the available markets for the compost;

(i) Provisions for fire prevention and control;

(j) Provisions for odor prevention and control;

(k) Provisions for the control of surface water runoff and runoff;

(l) Provisions for litter prevention and control;

(m) Contingency plans to be followed in the event of emergencies and unforeseen circumstances that may occur at the facility. The plans must provide, at a minimum, for an organized and coordinated course of action to be taken and address the following situations:

(1) A fire at the facility;

(2) A release of hazardous or toxic materials; and

(3) The shutdown of the facility for any reason; and

(n) Provisions for proper disposal of by-products.

2. Any person or municipality which maintains or operates a compost plant shall maintain and operate

the site in conformance with the following standards:

(a) If the compost plant accepts municipal solid waste and is not fully contained within a building, a buffer zone must be maintained of at least 500 feet from the adjoining property and 1,000 feet from any public roads.

(b) Incoming solid waste must be confined to as small an area as practicable. At the conclusion of each day of operation, all windblown material resulting from the operation must be collected and returned to the area.

(c) Materials resulting from composting and offered for sale:

(1) Must meet the requirements relating to the maximum allowable density of fecal coliform or *Salmonella* sp. bacteria for Class A sewage sludge set forth in 40 C.F.R. § 503.32(a);

(2) Must not reheat upon standing;

(3) Must be innocuous; and

(4) Must contain no sharp particles which could cause injury to persons handling the compost.

(d) By-products removed during the processing must be handled in a sanitary and nuisance-free manner and disposed of at a facility approved by the solid waste management authority.

3. A compost plant shall comply with the plans for the design and operation of the facility approved by the solid waste management authority. A compost plant shall not:

(a) Contribute to the pollution of the air or waters of this State;

(b) Cause an impairment of the environment;

(c) Cause a health or safety hazard to employees of the facility or the general public; or

(d) Cause a public nuisance.

4. The solid waste management authority may suspend or revoke a permit to operate a compost plant if the owner or operator of the facility fails to comply with the provisions of [NAC 444.570](#) to [444.7499](#), inclusive.

[Environmental Comm'n, Solid Waste Mgt Reg. §§ 4.2.1-4.2.2.4, eff. 9-21-77]—(NAC A by R105-02, 10-18-2002)

NAC 444.672 System to process waste: Incineration. ([NRS 444.560](#))

1. An incinerator plant must not be established until the site location, facilities and the proposed method of operation have been approved by the solid waste management authority.

2. All incineration equipment and air pollution control appurtenances thereto must comply with the requirements of [NAC 445B.001](#) to [445B.3689](#), inclusive, and any local regulations governing the construction and operation of incinerators.

3. Incinerators used for the burning of pathological waste, garbage or material of high moisture content must be high temperature types with either grate or solid hearth construction, drying shelves for wet wastes and an auxiliary heating unit to ensure temperatures of 1,400 degrees Fahrenheit for not less than 0.3 second.

4. Any person or municipality which maintains or operates an incinerator must maintain and operate the site in conformance with the following standards:

(a) Adequate storage must be provided for incoming solid wastes and for incinerator residue to assure a nuisance-free operation. Storage facilities must conform to the requirements of [NAC 444.660](#) to [444.666](#), inclusive.

(b) Incinerator residue must be disposed of at an approved land disposal site or in accordance with provisions of an operational plan as approved by the solid waste management authority.

(c) Provisions must be made for emergency disposal of all solid wastes handled by the plant in the event of plant breakdown.

(d) Salvaging, if permitted, must be controlled so as not to interfere with optimum operation or create unsightly conditions or vector harborage.

(e) All quench water, washdown water, dust spray or surface water carrying organic matter must be discharged into a sanitary sewer or otherwise disposed of as provided in an operational plan as approved by the solid waste management authority.

[Environmental Comm'n, Solid Waste Mgt Reg. §§ 4.3.1-4.3.4.5, eff. 9-21-77]

NAC 444.674 System to process waste: Salvage yard. ([NRS 444.560](#))

1. A salvage yard must not be established until the location, facilities and proposed method of operation have been approved by the solid waste management authority.
2. Salvage in a salvage yard must be stored in an orderly manner so as to prevent harboring rodents, any public nuisance and accidents.
3. All nonsalvageable material must be stored and disposed of according to [NAC 444.570](#) to [444.7499](#), inclusive. In no case may nonsalvageable items be stored for more than 1 week.
4. No garbage or similar putrescible material may be present at a salvage yard, except in approved containers for such materials.

[Environmental Comm'n, Solid Waste Mgt Reg. §§ 4.4.1-4.4.4, eff. 9-21-77]—(NAC A 9-2-92; 11-8-93; 3-1-94)

NAC 444.676 System to process waste: Other methods. ([NRS 444.560](#)) Before any method of solid waste processing, not otherwise provided for in these regulations, is placed into operation, complete plans, specifications and design data must meet the approval of the solid waste management authority.

[Environmental Comm'n, Solid Waste Mgt Reg. § 4.5, eff. 9-21-77]

NAC 444.6765 Closure of existing municipal solid waste landfill unit for failure to prove compliance with certain provisions. ([NRS 444.560](#))

1. Except as otherwise provided in this section, an existing municipal solid waste landfill unit which does not file the proof required by [NAC 444.6783](#), [444.6785](#) and [444.6795](#) must close by October 9, 1996, in accordance with [NAC 444.6891](#), [444.6892](#) and [444.6893](#), and must conduct postclosure activities in accordance with [NAC 444.6894](#).

2. The deadline for closure required by this section may be extended for not more than 2 years if the owner or operator demonstrates to the solid waste management authority that there is:

- (a) No available alternative for the disposal of waste; and
- (b) No immediate threat to public health and safety and the environment.

(Added to NAC by Environmental Comm'n, eff. 11-8-93)

Class I Sites

NAC 444.6769 Minimum requirements. ([NRS 444.560](#)) A Class I site must comply with the minimum requirements set forth in [NAC 444.6405](#) to [444.6435](#), inclusive, [444.645](#), [444.6665](#) to [444.6678](#), inclusive, [444.6765](#) to [444.7025](#), inclusive, and [444.7481](#) to [444.7499](#), inclusive. A Class I site which fails to comply with these minimum requirements shall be deemed to be an open dump for the purposes of solid waste planning and is prohibited.

(Added to NAC by Environmental Comm'n, eff. 11-8-93)

NAC 444.677 Application for permit to operate Class I site or lateral expansion thereof. ([NRS 444.553](#), [444.556](#), [444.560](#)) An application for a permit to operate a Class I site or a lateral expansion of a Class I site must be submitted to the solid waste management authority and must include:

1. The name, location and mailing address of the:
 - (a) Site;
 - (b) Owner of the site;
 - (c) Operator of the site; and
 - (d) Authorized agent of the owner.
2. Proof of ownership of the land on which the site will be located.
3. The report of the design of the site required by [NAC 444.680](#).
4. The plan for monitoring water required by [NAC 444.683](#).
5. The plan for operating the site required by [NAC 444.684](#).
6. A plan for closure required by [NAC 444.6895](#).
7. A plan for postclosure required by [NAC 444.6896](#).
8. A copy of the financial assurance required by [NAC 444.685](#).
9. Any additional information which the solid waste management authority may require.

(Added to NAC by Environmental Comm'n, eff. 9-2-92; A 11-8-93)

NAC 444.678 Location restrictions: Generally. ([NRS 444.560](#)) The location of a Class I site must:

1. Be easily accessible in all kinds of weather to all vehicles expected to use it.
 2. Prevent pollutants and contaminants from the municipal solid waste landfill units at the site from degrading the waters of the State.
 3. Prevent uncontrolled migration of gas at the site.
 4. Have an adequate quantity of earth cover that is workable and compactible and does not contain organic material of a quantity and distribution conducive to harboring and breeding disease vectors.
 5. Conform with land use planning of the area.
 6. Not be within one-fourth mile of the nearest inhabited dwelling or place of public gathering or be within 1,000 feet of a public highway, unless special provisions for the beautification of the site and the control of litter and vectors are included in the design and approved by the solid waste management authority.
 7. Meet with the approval of the solid waste management authority.
 8. Comply with the requirements set forth in [NAC 444.6765](#) and [444.6783](#) to [444.6795](#), inclusive.
 9. Unless approved by the solid waste management authority, not be within 1,000 feet of any surface water or 100 feet of the uppermost aquifer if the site is approved after September 2, 1992.
- [Environmental Comm'n, Solid Waste Mgt Reg. §§ 5.1-5.1.1.7, eff. 9-21-77]—(NAC A 9-2-92; 11-8-93; 3-1-94)

NAC 444.6783 Location restrictions: Airport safety. ([NRS 444.560](#))

1. A Class I site must meet the following safety requirements relating to airports:
 - (a) An owner or operator of a new or existing municipal solid waste landfill unit or a lateral expansion which is located:
 - (1) Within 10,000 feet of the end of any airport runway used by a turbojet aircraft; or
 - (2) Within 5,000 feet of the end of any airport runway used only by piston-type aircraft,

Ê shall maintain proof that the unit or lateral expansion is designed and operated so that it does not pose a hazard to aircraft.

 - (b) The owner or operator shall place the proof in the operating record of the municipal solid waste landfill unit and notify the solid waste management authority that the proof has been placed in the operating records.
 - (c) The owner or operator who proposes to locate a new municipal solid waste landfill unit or lateral expansion within a 5-mile radius of the end of any airport runway used by a turbojet or piston-type aircraft shall notify the affected airport and the Federal Aviation Administration.
 2. As used in this section:
 - (a) "Airport" means any public airport.
 - (b) "Hazard to aircraft" means an increase in the likelihood of a collision between a bird and an aircraft that may cause damage to the aircraft or injury to its occupants.
- (Added to NAC by Environmental Comm'n, eff. 11-8-93; A 10-3-96)

NAC 444.6785 Location restrictions: Floodplains. ([NRS 444.560](#))

1. The owner or operator of a new or existing municipal solid waste landfill unit or lateral expansion located in a 100-year floodplain shall maintain proof that the unit or lateral expansion will not:
 - (a) Restrict the flow of the floodplain;
 - (b) Reduce the temporary capacity of the floodplain to store water; and
 - (c) Result in the washout of solid waste that poses a hazard to public health and safety and the environment.
 2. The owner or operator shall place the proof in the operating records of the municipal solid waste landfill unit and notify the solid waste management authority that the proof has been placed within the operating records.
 3. As used in this section, "100-year floodplain" means the lowland and the relatively flat lands adjoining the waters that are inundated by a 100-year flood.
- (Added to NAC by Environmental Comm'n, eff. 11-8-93)

NAC 444.679 Location restrictions: Wetlands. ([NRS 444.560](#))

1. A new municipal solid waste landfill unit or a lateral expansion may not be located in wetlands unless the owner or operator satisfactorily demonstrates to the solid waste management authority and the Administrator that:

(a) The presumption, if applicable pursuant to section 404 of the federal Clean Water Act of 1977, 33 U.S.C. § 1344, as that section existed on November 8, 1993, that a practicable alternative to the proposed unit or lateral expansion is available which does not involve wetland is clearly rebutted.

(b) The construction and operation of the municipal solid waste landfill unit or lateral expansion will not:

(1) Cause or contribute to violations of any applicable state water quality standard set forth in [NAC 445A.450](#) to [445A.492](#), inclusive;

(2) Violate any applicable toxic effluent standard or prohibition set forth in section 307 of the federal Clean Water Act of 1977, 33 U.S.C. § 1317, as that section existed on November 8, 1993;

(3) Jeopardize the continued existence of endangered or threatened species, or result in the destruction or adverse modification of a critical habitat, protected by the federal Endangered Species Act of 1973, 16 U.S.C. §§ 1531 et seq., as that act existed on November 8, 1993; and

(4) Violate any requirement set forth in the Marine Protection, Research and Sanctuaries Act of 1972, 33 U.S.C. §§ 1401 et seq., for the protection of a marine sanctuary, as that act existed on November 8, 1993.

(c) The site will not cause or contribute to any significant degradation of the wetlands. The owner or operator shall demonstrate the integrity of the municipal solid waste landfill unit or lateral expansion and its ability to protect ecological resources by showing:

(1) The potential erosion, stability and migration of the soils, muds and deposits of the wetlands that are used to support the site;

(2) The potential erosion, stability and migration of dredged and fill materials used to support the site;

(3) The volume and chemical composition of the waste managed at the site;

(4) The potential impact on fish, wildlife and other aquatic resources and their habitat;

(5) The potential effects of a catastrophic release of waste to the wetlands and the resulting impacts on the environment; and

(6) Any additional factors required by the solid waste management authority to show that the ecological resources in the wetlands are protected.

(d) To the extent required by section 404 of the Clean Water Act, 33 U.S.C. § 1344, as that section existed on November 8, 1993, or any applicable state laws, actions have been taken to attempt to achieve no net loss of wetlands, as defined by acreage and function, by first avoiding impacts to wetlands to the maximum extent practicable as required by paragraph (a), then minimizing the unavoidable impacts to the maximum extent practicable, and then offsetting the remaining unavoidable impacts on the wetlands through all appropriate and practicable mitigation actions such as restoration of existing degraded wetlands or the creation of an artificially created wetland.

(e) Sufficient information is available to make a reasonable determination with respect to these demonstrations.

2. As used in this section, "wetlands" means those areas that are inundated or saturated by surface or groundwater at a frequency and duration sufficient to support, and which under normal circumstances do support, a prevalence of vegetation typically adapted for life in saturated soils, including swamps, marshes, bogs and other similar areas.

(Added to NAC by Environmental Comm'n, eff. 11-8-93)

NAC 444.6791 Location restrictions: Fault areas. ([NRS 444.560](#))

1. A new municipal solid waste landfill unit or lateral expansion must not be located within 200 feet of a fault that has had a displacement in Holocene time unless the owner or operator demonstrates to the solid waste management authority that an alternative setback distance of less than 200 feet will prevent damage to the structural integrity of the unit and will protect public health and safety and the environment.

2. As used in this section:

(a) "Displacement" means the relative movement of any two sides of a fault measured in any direction.

(b) "Fault" means a fracture or a zone of fractures in any material along which strata on one side have been displaced with respect to that on the other side.

(c) "Holocene" means the most recent epoch of the Quaternary period, extending from the end of the Pleistocene Epoch to the present.

(Added to NAC by Environmental Comm'n, eff. 11-8-93)

NAC 444.6793 Location restrictions: Seismic impact zones. ([NRS 444.560](#))

1. A new municipal solid waste landfill unit or lateral expansion may not be located in a seismic impact zone, unless the owner or operator submits proof to the solid waste management authority that all structures for containment, including liners, systems for the collection of leachate and systems for the control of surface water, are designed to resist the maximum horizontal acceleration in lithified earth material for the site. The owner or operator shall place the proof in the operating records for the site and notify the solid waste management authority that the proof has been placed in the operating records.

2. As used in this section:

(a) "Lithified earth material" means all rock, including all naturally occurring and naturally formed aggregates or masses of minerals or small particles of older rock which formed by the crystallization of magma or by the induration of loose sediments. The term does not include artificially created materials, such as fill, concrete and asphalt, or unconsolidated earth materials, soils or regolith lying at or near the surface of the earth.

(b) "Maximum horizontal acceleration" means the maximum expected horizontal acceleration depicted on a seismic hazard map with a 90 percent or greater probability that the acceleration will not be exceeded in 250 years, or the maximum expected horizontal acceleration based on a seismic risk assessment for the specific site.

(c) "Seismic impact zone" means an area with a 10 percent or greater probability that the maximum horizontal acceleration in lithified earth material will exceed 10 percent of the earth's gravitational pull in 250 years, as determined by referencing the United States Geological Survey, Open File Report 82-1033, "Probabilistic Estimates of Maximum Acceleration and Velocity in Rock in the Contiguous United States."

(Added to NAC by Environmental Comm'n, eff. 11-8-93; A 3-1-94)

NAC 444.6795 Location restrictions: Unstable areas. ([NRS 444.560](#))

1. The owner or operator of a new or existing municipal solid waste landfill unit or a lateral expansion located in an unstable area shall maintain proof that engineering measures have been incorporated into the structural design of the unit or lateral expansion to ensure that the integrity of the unit or lateral expansion will not be disrupted. The owner or operator shall place the proof in the design report and the operating records of the unit and notify the solid waste management authority that the proof has been placed in the operating records.

2. To determine if an area is unstable, the owner or operator shall consider:

(a) Conditions of the soil on or near the site which may result in a significant differential settling;

(b) Geologic or geomorphic features on or near the site; and

(c) Artificially created features or events which are on the surface or subsurface.

3. As used in this section:

(a) "Areas susceptible to mass movement" means those areas where the movement of earth material at, beneath or adjacent to the unit, because of natural or artificially created features, results in the downslope movement of soil and rock by means of gravitational influence. The term includes, but is not limited to, areas with landslides, avalanches, debris, slides and flows, block slidings and rock falls.

(b) "Karst terranes" means areas where karst topography, with its characteristic surface and subterranean features, is developed as the result of the dissolution of limestone, dolomite or soluble rock. The term includes, but is not limited to, areas with sinkholes, sinking streams, caves, large springs and blind valleys.

(c) "Poor foundation conditions" means those areas with features which indicate that a natural or human-caused event may result in an inadequate foundation for the structural components of a municipal solid waste landfill unit or lateral expansion.

(d) "Structural components" means liners, systems for leachate collection, final cover, systems for runoff and any other component used in the construction and operation of a municipal solid waste landfill unit which is necessary for the protection of public health and safety and the environment.

(e) "Unstable area" means a location which is susceptible to natural or artificially created features that are

capable of impairing the integrity of some or all of the structural components of a municipal solid waste landfill unit that will prevent the release of the solid waste, or any by-product thereof, from that landfill. The term includes poor foundation conditions, areas susceptible to mass movements and karst terranes.

(Added to NAC by Environmental Comm'n, eff. 11-8-93)

NAC 444.680 Report of design. (NRS 444.560) The report of the design of a Class I site must:

1. Be signed by a professional engineer registered in this State.
2. Include a general location map showing land use and zoning within 1 mile of the disposal site.
3. Include plans and specifications of the facility which are of sufficient detail to show compliance with the applicable design standards and provide a clear understanding of the development of the site. The plan must:
 - (a) Be at a scale of not more than 200 feet to the inch, including contour intervals of not more than 5 feet.
 - (b) Show the topography of the site before the development.
 - (c) Show the proposed limits of excavation and fill areas, including:
 - (1) The final elevations and grades of each municipal solid waste landfill unit on the site;
 - (2) The system for final cover;
 - (3) The location and placement of each system of liners; and
 - (4) Each system for the collection and removal of leachate showing all critical grades and elevations of the inverts and drainage envelopes for the collection pipes, manholes, cleanouts, valves and sumps and showing the thicknesses of the drainage blankets.
 - (d) Show any proposed soil borrow areas.
 - (e) Show the sequence of development for the facility including an outline of fill areas, the sequence of filling operations and the locations of access roads.
 - (f) Show access roads, including dimensions, slopes, profiles and the types of pavement to be used.
 - (g) Show a typical cross section of the landfill.
 - (h) Show grades, berms, dikes, swales and other devices for proper drainage and control of surface water, runoff and runoff for the site.
 - (i) Show the devices for monitoring and controlling the gases at the site.
 - (j) Show fencing, equipment shelter, employee facilities and all other features for the development of the site.
4. Define the population and area to be served by the site.
5. Define the anticipated types, quantities and sources of solid wastes to be disposed of at the site.
6. Define the source, type and quantity of cover material.
7. Include proof of compliance with the requirements relating to the control of surface water set forth in [NAC 444.6885](#) and [444.6887](#).
8. Contain documentation that the disposal site is in compliance with [NAC 444.681](#), including:
 - (a) Appropriate charts and graphs;
 - (b) Soil borings, test pit logs and other relevant geologic information;
 - (c) Engineering calculations; and
 - (d) Other supporting data, including literature citations.

[Environmental Comm'n, Solid Waste Mgt Reg. §§ 5.1.2.1-5.1.2.3.8, eff. 9-21-77]—(NAC A 9-2-92; 11-8-93)

NAC 444.681 Design criteria. (NRS 444.560)

1. A new municipal solid waste landfill unit or lateral expansion must be constructed:
 - (a) In accordance with a design approved by the solid waste management authority that is sufficient to protect the waters of the State from degradation by pollutants or contaminants; or
 - (b) With a composite liner and a system for the collection of leachate which is designed and constructed to maintain less than a 30-centimeter depth of leachate over the liner. The composite liner must have an upper component consisting of a flexible membrane liner of at least 30 mils and a lower component consisting of a layer of compacted soil that is at least 2 feet with a hydraulic conductivity of no more than 10^{-7} centimeters per second. Components of the flexible membrane liner consisting of high density polyethylene must be at least 60 mils. The flexible membrane liner must be installed in direct and uniform contact with the compacted

soil.

2. To approve the design of a new municipal solid waste landfill unit or lateral expansion, the solid waste management authority shall consider:

- (a) The hydrogeologic characteristics of the facility and surrounding land;
- (b) The climate of the area;
- (c) The volume and physical and chemical characteristics of the anticipated leachate; and
- (d) Any other relevant factors.

(Added to NAC by Environmental Comm'n, eff. 11-8-93)

NAC 444.683 Plan for monitoring water; suspension of monitoring requirements. ([NRS 444.560](#))

1. The plan for monitoring water for a Class I site must provide a complete description of a system capable of monitoring the performance of the design of the site, including monitoring of the groundwater to detect the release of pollutants or contaminants from the municipal solid waste landfill unit into the waters of the State.

2. The plan must:

- (a) Identify the location and construction of monitoring points;
- (b) Specify monitoring parameters and the frequency of monitoring those parameters;
- (c) Specify procedures for quality assurance for all field and laboratory work;
- (d) Provide for the semiannual submittal of monitoring data to the solid waste management authority;
- (e) Establish procedures which must be used if monitoring provides evidence of leachate migration; and
- (f) Comply with [NAC 444.7481](#) to [444.7499](#), inclusive.

3. The solid waste management authority may suspend monitoring requirements if the owner or operator of a Class I site demonstrates that there is no potential for migration of pollutants or contaminants from the site to waters of the State during the active life of the site, including the period for closure and postclosure. The demonstration must be:

(a) Certified by a qualified groundwater scientist and approved by the solid waste management authority; and

(b) Based on:

(1) Measurements collected at a specific field site, sampling and an analysis of physical, chemical and biological processes affecting the fate and transportation of pollutants or contaminants; and

(2) Predictions of the fate and transportation of the pollutants or contaminants that consider the maximum rate of the migration of contaminants and the impact of the pollutants or contaminants on public health and safety and the environment.

(Added to NAC by Environmental Comm'n, eff. 9-2-92; A 11-8-93)

NAC 444.6835 Schedule for compliance with monitoring requirements. ([NRS 444.560](#)) Except as otherwise provided in [NAC 444.7482](#), the owner or operator of a municipal solid waste landfill unit in a Class I site shall comply with the requirements for monitoring groundwater according to the following schedule:

1. An existing municipal solid waste landfill unit and lateral expansion that is less than 1 mile from a surface or subsurface intake for drinking water must comply with [NAC 444.7483](#) to [444.7492](#), inclusive, by October 9, 1994.

2. An existing municipal solid waste landfill unit and lateral expansion that is at least 1 mile but less than 2 miles from a surface or subsurface intake for drinking water must comply with [NAC 444.7483](#) to [444.7492](#), inclusive, by October 9, 1995.

3. An existing municipal solid waste landfill unit and lateral expansion that is at least 2 miles from a surface or subsurface intake for drinking water must comply with [NAC 444.7483](#) to [444.7492](#), inclusive, by October 9, 1996.

4. A new municipal solid waste landfill unit must comply with [NAC 444.7483](#) to [444.7492](#), inclusive, before waste may be placed in the unit.

(Added to NAC by Environmental Comm'n, eff. 11-9-95)

NAC 444.684 Plan for operating. ([NRS 444.560](#)) The plan for operating a Class I site must:

1. Include a description of the equipment and persons necessary to operate the site;
2. Provide for:
 - (a) Adequate fire control methods to extinguish and prevent the spread of accidental fires;
 - (b) The prevention of scattering of papers and other lightweight debris by portable litter fences or other suitable devices; and
 - (c) The disposal of any special wastes specifically permitted by the solid waste management authority;
3. Show how the site will comply with the requirements set forth in [NAC 444.6665](#) to [444.6678](#), inclusive, and [444.686](#) to [444.7025](#), inclusive; and
4. Include a plan of action to be taken in the event of an emergency which might occur at the site. The plan must include, without limitation, an organized, coordinated and technically and financially feasible course of action to be taken:
 - (a) If a fire occurs at the site, including identifying the nearest fire department and how and under what circumstances the fire department will be notified.
 - (b) To protect the safety of personnel and users of the site, including training for employees on first aid and the availability of emergency services. The site must have a telephone, radio or other similar communication device to enable the personnel to contact the appropriate providers of emergency services.
 - (c) To shut down the site because of inclement weather or an act of God.
 - (d) If equipment breaks down, including the provision for and a description of backup equipment.
 - (e) If hazardous or toxic materials are released from the site.
 - (f) If the presence of leachate is detected in a structure for the collection of leachate which was previously dry, or if a spill or leak occurs at a tank or surface impoundment for the storage of leachate. [Environmental Comm'n, Solid Waste Mgt Reg. §§ 5.1.2.5-5.1.2.10, eff. 9-21-77]—(NAC A 9-2-92; 11-8-93; 11-9-95)

NAC 444.685 Financial assurance: Compliance mandatory; exemptions; waiver. ([NRS 444.560](#))

1. Except as otherwise provided in this section, the owner or operator of a Class I site or lateral expansion of a Class I site shall comply with the provisions of [NAC 444.6851](#) to [444.6859](#), inclusive.
2. Owners or operators of Class I sites:
 - (a) Who are entities of the State of Nevada or the Federal Government; and
 - (b) Whose debts and liabilities are the debts and liabilities of the State of Nevada or the Federal Government,
 are exempt from the provisions of this section.
3. The solid waste management authority may approve an alternate plan for financial assurance if the alternate plan meets the criteria set forth in [NAC 444.6859](#).
4. The solid waste management authority may waive compliance with the provisions of [NAC 444.6851](#) to [444.6859](#), inclusive, for a period not to extend beyond April 9, 1998, if an owner or operator demonstrates that:
 - (a) The date for compliance set forth in [NAC 444.6851](#) to [444.6859](#), inclusive, does not provide the owner or operator with sufficient time to comply with the provisions of those sections; and
 - (b) A waiver will not adversely affect human health and the environment.
 (Added to NAC by Environmental Comm'n, eff. 11-8-93; A 3-1-94; 10-29-97)

NAC 444.6851 Financial assurance: Estimate for cost of plan for closure; adjustments to estimate. ([NRS 444.560](#))

1. The owner or operator shall obtain a detailed written estimate, in current dollars, of the cost of hiring a third person to close the largest area of all municipal solid waste landfill units within the site requiring a final cover as required by [NAC 444.6891](#) at any time during the active life of the unit, in accordance with the plan for closure. The owner or operator shall notify the solid waste management authority that the estimate has been placed in the operating records of the disposal site.
2. The estimate must equal the cost of closing the largest area of all municipal solid waste landfill units within the site requiring a final cover at any time during the active life of the unit when the extent and manner of its operation would make closure the most expensive, as indicated by the plan for closure.
3. During the active life of the municipal solid waste landfill unit, the owner or operator shall annually

adjust the estimate for inflation.

4. The owner or operator shall increase the estimate and amount of financial assurance if changes to the plan for closure or conditions at the municipal solid waste landfill unit increase the maximum cost of closure at any time during the remaining active life of the unit.

5. The owner or operator may reduce the estimate and amount of financial assurance if the estimate exceeds the maximum cost of closure at any time during the remaining life of the municipal solid waste landfill unit. The owner or operator shall notify the solid waste management authority that the justification for the reduction has been placed in the operating records of the site.

6. The owner or operator of each municipal solid waste landfill unit shall establish financial assurance for closure of the municipal solid waste landfill unit in compliance with [NAC 444.68525](#) to [444.6859](#), inclusive. The owner or operator shall provide continuous coverage for closure until released by the solid waste management authority from the requirements for financial assurance by demonstrating compliance with [NAC 444.6893](#).

(Added to NAC by Environmental Comm'n, 11-8-93, eff. 4-9-95)

NAC 444.68515 Financial assurance: Estimate for cost of program for postclosure; adjustments to estimate. ([NRS 444.560](#))

1. The owner or operator shall obtain a detailed written estimate, in current dollars, of the cost of hiring a third person to conduct a program for postclosure for each of the municipal solid waste landfill units within the site in compliance with the plan for postclosure developed pursuant to [NAC 444.6894](#). The estimate for postclosure used to demonstrate financial assurance pursuant to subsection 6 must account for the total costs of conducting the program for postclosure, including annual and periodic costs as described in the plan for postclosure over the entire period for postclosure. The owner or operator shall notify the solid waste management authority that the estimate has been placed in the operating records of the unit.

2. The estimate for postclosure must be based on the most expensive costs of postclosure during the period for postclosure.

3. During the active life of the municipal solid waste landfill unit and the period for postclosure, the owner or operator shall annually adjust the estimate for postclosure for inflation.

4. The owner or operator shall increase the estimate for postclosure and amount of financial assurance if changes in the plan for postclosure or the conditions of the municipal solid waste landfill unit increase the maximum costs of postclosure.

5. The owner or operator may reduce the estimate for postclosure and amount of financial assurance if the estimate exceeds the maximum costs of postclosure remaining over the period for postclosure. The owner or operator shall notify the solid waste management authority that the justification for the reduction has been placed in the operating records of the unit.

6. The owner or operator of each municipal solid waste landfill unit shall establish, in accordance with [NAC 444.68525](#) to [444.6859](#), inclusive, financial assurance for the costs of postclosure as required by [NAC 444.6894](#). The owner or operator shall provide continuous coverage for postclosure until released by the solid waste management authority from the requirements of financial assurance for postclosure by demonstrating compliance with subsection 3 of [NAC 444.6894](#).

(Added to NAC by Environmental Comm'n, 11-8-93, eff. 4-9-95)

NAC 444.6852 Financial assurance: Estimate for cost of plan for corrective action; adjustments to estimate. ([NRS 444.560](#))

1. An owner or operator of a municipal solid waste landfill unit required to undertake a plan for corrective action pursuant to [NAC 444.7497](#), [444.7498](#) and [444.7499](#), shall obtain a detailed written estimate, in current dollars, of the cost of hiring a third person to perform the corrective action in accordance with that plan. The estimate of the corrective action must account for the total cost of activities for corrective action as described in the plan for corrective action for the period of the plan. The owner or operator shall notify the solid waste management authority that the estimate has been placed in the operating records of the unit.

2. The owner or operator shall annually adjust the estimate for inflation until the plan for corrective action is completed in accordance with [NAC 444.7497](#), [444.7498](#) and [444.7499](#).

3. The owner or operator shall increase the estimate for corrective action and amount of financial

assurance if changes in the plan for corrective action or conditions at the municipal solid waste landfill unit increase the maximum costs of the corrective action.

4. The owner or operator may reduce the amount of the estimate for corrective action and amount of financial assurance if the estimate exceeds the maximum remaining costs of the corrective action. The owner or operator shall notify the solid waste management authority that the justification for the reduction has been placed in the operating records of the unit.

5. The owner or operator of each municipal solid waste landfill unit required to undertake a plan for corrective action pursuant to [NAC 444.7497](#), [444.7498](#) and [444.7499](#), shall establish, in accordance with [NAC 444.68525](#) to [444.6859](#), inclusive, financial assurance for the most recent plan for corrective action. The owner or operator shall provide continuous coverage for corrective action until released by the solid waste management authority from the requirements of financial assurance for corrective action by demonstrating compliance with [NAC 444.7499](#).

(Added to NAC by Environmental Comm'n, 11-8-93, eff. 4-9-95; A 11-9-95)

NAC 444.68525 Financial assurance: Allowable mechanisms. (NRS 444.560) The mechanisms used to demonstrate financial assurance pursuant to [NAC 444.685](#) must ensure that the money necessary to meet the cost of closure, postclosure and corrective action for known releases of contaminants will be available whenever it is needed. The financial assurance may be in the form of:

1. A trust fund as described in [NAC 444.6853](#);
2. A surety bond guaranteeing payment or performance as described in [NAC 444.68535](#);
3. A letter of credit as described in [NAC 444.6854](#);
4. A policy of insurance as described in [NAC 444.6855](#);
5. A mechanism approved by the solid waste management authority pursuant to [NAC 444.6856](#);
6. An assumption of responsibility by the State as described in [NAC 444.6857](#); or
7. Any combination of the options listed in subsections 1 to 6, inclusive.

(Added to NAC by Environmental Comm'n, 11-8-93, eff. 4-9-95)

NAC 444.6853 Financial assurance: Trust fund. (NRS 444.560)

1. An owner or operator may satisfy the requirements of [NAC 444.685](#) by establishing a trust fund which conforms to the requirements of this section. The trustee must be an entity which has the authority to act as a trustee and whose trust operations are regulated and examined by a federal or state agency. A copy of the trust agreement must be placed in the operating records of the disposal site.

2. The owner or operator shall annually make payments into the trust fund over the term of the period for payment into the fund.

3. If a trust fund is used to demonstrate financial assurance for closure and postclosure, the first payment into the fund must be at least equal to the current estimate of the cost for closure or postclosure, except as otherwise provided in [NAC 444.6857](#), divided by the number of years of the period for payment into the fund. The amount of subsequent payments must be determined by the following formula:

$$\text{Next Payment} = \frac{\text{CE}-\text{CV}}{\text{Y}}$$

where:

CE is the current estimate for closure or postclosure, as adjusted for inflation or other changes.

CV is the current value of the trust fund.

Y is the number of years remaining in the period for payment into the fund.

4. If a trust fund is used to demonstrate financial assurance for corrective action, the first payment into the trust fund must be at least equal to one-half of the current estimate of the cost for corrective action, except as otherwise provided in [NAC 444.6857](#), divided by the number of years in the period for payment into the

fund. The amount of subsequent payments must be determined by the following formula:

$$\text{Next Payment} = \frac{\text{RB-CV}}{\text{Y}}$$

where:

RB is the most recent estimate of the required balance in the trust fund needed for corrective action.

CV is the current value of the trust fund.

Y is the number of years remaining in the period for payment into the trust fund.

5. The owner or operator shall:

(a) For a trust fund for closure and postclosure, obtain and make the initial payment into the trust fund before April 9, 1997, or the initial receipt of solid waste, whichever is later.

(b) For a trust fund for corrective action, obtain the trust fund and make the initial payment into the trust fund no later than 120 days after the remedy for corrective action has been selected in accordance with the requirements of [NAC 444.7497](#), [444.7498](#) and [444.7499](#).

(c) Maintain the trust fund until he or she is no longer required to demonstrate financial responsibility pursuant to [NAC 444.6851](#), [444.68515](#) and [444.6852](#).

6. If the owner or operator establishes a trust fund after having used one or more alternate mechanisms specified in [NAC 444.68525](#), the first payment into the trust fund must be at least equal to the amount which the fund would have contained if the trust fund were established initially and annual payments made pursuant to this section.

7. The owner, operator or any other person authorized to conduct activities for closure, postclosure or corrective action may request reimbursement from the trustee for related expenditures. Requests for reimbursement may be granted by the trustee only if sufficient money is remaining in the trust fund to cover the remaining costs of closure, postclosure or corrective action, and if justification and documentation of the cost is placed in the operating records of the disposal site. The owner or operator shall notify the solid waste management authority that the documentation of the justification for reimbursement has been placed in the operating records and that reimbursement has been received.

8. The owner or operator may terminate the trust fund only if he or she substitutes alternate financial assurance as specified in this section or is no longer required to demonstrate financial responsibility in accordance with the requirements of [NAC 444.6851](#), [444.68515](#) or [444.6852](#).

9. As used in this section, "period for payment into the fund" means:

(a) In the case of a trust fund for closure or postclosure, the remaining life of the municipal solid waste landfill unit.

(b) In the case of a trust fund for corrective action, over one-half of the estimated length of the program for corrective action.

(Added to NAC by Environmental Comm'n, 11-8-93, eff. 4-9-95; A 11-9-95)

NAC 444.68535 Financial assurance: Surety bond guaranteeing payment or performance. ([NRS 444.560](#))

1. An owner or operator may demonstrate financial assurance for closure or postclosure by obtaining a surety bond guaranteeing payment or performance which conforms to the requirements of this section. An owner or operator may demonstrate financial assurance for corrective action by obtaining a surety bond guaranteeing performance which conforms to the requirements of this section.

2. A bond must:

(a) If for closure and postclosure, be obtained by the owner or operator and become effective before April 9, 1997, or the initial receipt of waste, whichever is later.

(b) If for corrective action, be obtained by the owner or operator and become effective no later than 120 days after the remedy for corrective action has been selected in accordance with the requirements of [NAC](#)

[444.7497](#), [444.7498](#) and [444.7499](#).

(c) Be maintained until the owner or operator is no longer required to demonstrate financial responsibility pursuant to [NAC 444.6851](#), [444.68515](#) and [444.6852](#).

3. The owner or operator shall notify the solid waste management authority that a copy of the bond has been placed in the operating records of the disposal site.

4. The surety company issuing the bond must be among those listed as an acceptable surety on federal bonds in Circular 570 of the U.S. Department of the Treasury which is published each July in the Federal Register.

5. Except as otherwise provided in [NAC 444.6858](#), the sum of the bond must be in an amount at least equal to the current estimate for closure, postclosure or corrective action, whichever is applicable.

6. The surety must become liable on the bond if the owner or operator fails to make payments or perform as guaranteed by the bond.

7. In addition to obtaining the surety bond, the owner or operator shall establish a trust fund. The trust fund must meet the requirements of [NAC 444.6853](#), except the requirements for initial payment and subsequent annual payments specified in that section.

8. The surety shall deposit payments made under the terms of the bond directly into the trust fund. Payments from the trust fund must be approved by the trustee.

9. The terms of the bond must authorize the surety to cancel the bond by sending notice of cancellation by certified mail to the owner or operator and to the solid waste management authority at least 120 days before cancellation. If the surety cancels the bond, the owner or operator shall obtain alternate financial assurance as specified in [NAC 444.68525](#) to [444.6859](#), inclusive.

10. The owner or operator may cancel the bond only if alternate financial assurance is substituted as specified in [NAC 444.68525](#) to [444.6859](#), inclusive, or the owner or operator is no longer required to demonstrate financial responsibility in accordance with [NAC 444.6851](#), [444.68515](#) or [444.6852](#).

(Added to NAC by Environmental Comm'n, 11-8-93, eff. 4-9-95; A 11-9-95)

NAC 444.6854 Financial assurance: Letter of credit. ([NRS 444.560](#))

1. An owner or operator may satisfy the requirements of [NAC 444.685](#) by obtaining an irrevocable letter of credit which conforms to the requirements of this section.

2. A letter of credit must:

(a) If for closure and postclosure, be obtained by the owner or operator and become effective before April 9, 1997, or the initial receipt of waste, whichever is later.

(b) If for corrective action, be obtained by the owner or operator and become effective no later than 120 days after the remedy for corrective action has been selected in accordance with the requirements of [NAC 444.7497](#), [444.7498](#) and [444.7499](#).

(c) Be maintained until the owner or operator is no longer required to demonstrate financial responsibility pursuant to [NAC 444.6851](#), [444.68515](#) and [444.6852](#).

3. The owner or operator shall notify the solid waste management authority that a copy of the letter of credit has been placed in the operating records of the disposal site.

4. The issuing institution must be an entity which has the authority to issue letters of credit and whose operations are regulated and examined by a federal or state agency.

5. A letter from the owner or operator must be filed with the letter of credit in the operating records that includes:

(a) A reference to the letter of credit by number;

(b) The issuing institution;

(c) The date of issuance;

(d) The name of the owner or operator;

(e) The address of the disposal site; and

(f) The amount of money assured.

6. Except as otherwise provided in this section, the letter of credit must be irrevocable and issued for a period of at least 1 year in an amount at least equal to the current estimate for closure, postclosure or corrective action, whichever is applicable. The letter of credit must provide that the expiration date will be automatically extended for a period of at least 1 year unless the issuing institution has cancelled the letter of

credit.

7. The terms of the letter of credit must authorize the issuing institution to cancel the letter of credit by sending notice of cancellation by certified mail to the owner or operator and to the solid waste management authority at least 120 days before the cancellation. If the letter of credit is cancelled by the issuing institution, the owner or operator shall obtain alternate financial assurance.

8. The owner or operator may cancel the letter of credit only if alternate financial assurance is substituted as specified in [NAC 444.68525](#) to [444.6859](#), inclusive, or the owner or operator is released from the requirements of this section in accordance with [NAC 444.6851](#), [444.68515](#) or [444.6852](#).

(Added to NAC by Environmental Comm'n, 11-8-93, eff. 4-9-95; A 11-9-95)

NAC 444.6855 Financial assurance: Insurance. ([NRS 444.560](#))

1. An owner or operator may demonstrate financial assurance for closure and postclosure by obtaining insurance which conforms to the requirements of this section.

2. The insurance must:

(a) Be obtained by the owner or operator and become effective before April 9, 1997, or the initial receipt of waste, whichever is later; and

(b) Be maintained until the owner or operator is no longer required to demonstrate financial responsibility pursuant to [NAC 444.6851](#), [444.68515](#) and [444.6852](#).

3. The insurer must be licensed to transact the business of insurance, or eligible to provide insurance as an excess or surplus lines insurer, in this State.

4. The owner or operator shall notify the solid waste management authority that a copy of the policy of insurance has been placed in the operating records of the disposal site.

5. The policy of insurance must guarantee that money will be available to close the municipal solid waste landfill unit whenever final closure occurs or to carry out a program for postclosure whenever the period of postclosure begins, whichever is applicable. The policy must also guarantee that once closure or postclosure begins, the insurer is responsible for paying money to the owner, operator or any other person authorized to conduct the closure or postclosure, up to an amount equal to the face amount of the policy.

6. Except as otherwise provided in [NAC 444.6853](#), the policy of insurance must be issued for a face amount at least equal to the current estimate for closure or postclosure, whichever is applicable. Actual payments by the insurer must not change the face amount, although the insurer's future liability may be lowered by the amount of the payments.

7. An owner, operator or any other person authorized to conduct the closure or postclosure may receive reimbursements for related expenditures. Requests for reimbursement may be granted by the insurer only if the remaining value of the policy is sufficient to cover the remaining costs of the closure or postclosure, and if justification and documentation of the cost is placed in the operating records of the disposal site. The owner or operator shall notify the solid waste management authority that documentation of the justification for reimbursement has been placed in the operating records and that reimbursement has been received.

8. Each policy of insurance must contain a provision allowing the assignment of the policy to a successor owner or operator. The assignment may be conditional upon the consent of the insurer, if the consent is not unreasonably refused.

9. The policy of insurance must provide that the insurer may not cancel, terminate or fail to renew the policy except for a failure to pay the premium. An automatic renewal of the policy must, at a minimum, provide the insured with the option of renewal at the face amount of the expiring policy. If there is a failure to pay the premium, the insurer may cancel the policy by sending notice of cancellation by certified mail to the owner, operator and solid waste management authority at least 120 days before the cancellation. If the insurer cancels the policy, the owner or operator shall obtain alternate financial assurance as specified in [NAC 444.68525](#) to [444.6859](#), inclusive.

10. If a policy of insurance provides coverage for postclosure, the insurer shall, commencing on the date that liability to make payments pursuant to the policy accrues, annually increase the face amount of the policy. The increase must be equivalent to the face amount of the policy, less any payments made, multiplied by an amount equal to 85 percent of the most recent rate of interest for or 85 percent of the equivalent yield announced by the United States Treasury for 26-week treasury bills.

11. The owner or operator may cancel the policy of insurance only if he or she substitutes alternate

financial assurance in accordance with [NAC 444.68525](#) to [444.6859](#), inclusive, or he or she is no longer required to demonstrate financial responsibility in accordance with the requirements of [NAC 444.6851](#), [444.68515](#) and [444.6852](#).

12. As used in this section, “face amount” means the total amount the insurer is obligated to pay under the policy.

(Added to NAC by Environmental Comm’n, 11-8-93, eff. 4-9-95; A 11-9-95)

NAC 444.6856 Financial assurance: Alternate mechanisms approved by solid waste management authority. (NRS 444.560)

1. An owner or operator may satisfy the requirements of [NAC 444.685](#) by obtaining any other mechanism which:

- (a) Meets the criteria specified in [NAC 444.6859](#); and
- (b) Is approved by the solid waste management authority.

2. A mechanism obtained pursuant to this section must be obtained by the owner or operator:

- (a) For closure and postclosure, by April 9, 1997, or before the initial receipt of waste, whichever is later.
- (b) For corrective action, no later than 120 days after the remedy for corrective action has been selected in accordance with the requirements of [NAC 444.7497](#), [444.7498](#) and [444.7499](#).

(c) Maintained until the owner or operator is no longer required to demonstrate financial responsibility pursuant to [NAC 444.6851](#), [444.68515](#) and [444.6852](#).

(Added to NAC by Environmental Comm’n, 11-8-93, eff. 4-9-95; A 11-9-95)

NAC 444.6857 Financial assurance: Assumption of responsibility by State. (NRS 444.560) If this State assumes legal responsibility for an owner’s or operator’s compliance with the requirements for closure, postclosure or corrective action set forth in [NAC 444.570](#) to [444.7499](#), inclusive, or assures that money will be available from the State to cover the related expenses, the owner or operator shall be deemed to be in compliance with the requirements of [NAC 444.685](#). Any assumption of responsibility by this State must meet the criteria specified in [NAC 444.6859](#).

(Added to NAC by Environmental Comm’n, 11-8-93, eff. 4-9-95; A 3-1-94)

NAC 444.6858 Financial assurance: Use of multiple mechanisms. (NRS 444.560)

1. Except as otherwise provided in subsection 2, an owner or operator may satisfy the requirements of [NAC 444.685](#) by establishing more than one mechanism for financial assurance per municipal solid waste landfill unit as specified in [NAC 444.6853](#) to [444.6857](#), inclusive. The combination of mechanisms, rather than a single mechanism, must provide financial assurance for an amount at least equal to the current estimate of cost for closure, postclosure or corrective action, whichever is applicable.

2. Any financial assurance provided by:

(a) A corporate parent, if the entity holding the financial mechanism is a subsidiary of the corporate parent or a subsidiary of a subsidiary of the corporate parent; or

(b) Another subsidiary of the corporate parent, if the entity holding the financial mechanism is a subsidiary of the same corporate parent,

È may not be combined if the financial statements of the two entities are consolidated.

(Added to NAC by Environmental Comm’n, 11-8-93; eff. 4-9-95)

NAC 444.6859 Financial assurance: General requirements for all mechanisms. (NRS 444.560)

1. An entity providing the mechanism used to demonstrate financial assurance pursuant to [NAC 444.685](#) shall reimburse or make payments to the owner, operator or any other person designated by the solid waste management authority, from that mechanism, for expenses in such amounts as the solid waste management authority shall direct in writing.

2. Any such mechanism must:

(a) Ensure that the amount of money assured is sufficient to cover the costs of closure, postclosure or corrective action for known releases of contaminants, when needed;

(b) Ensure that money will be available in a timely fashion, when needed; and

(c) Be legally valid, binding and enforceable under applicable state and federal law.

(Added to NAC by Environmental Comm'n, 11-8-93; eff. 4-9-95)

NAC 444.686 Operation and maintenance. ([NRS 444.560](#))

1. The operation and maintenance of a Class I site must be in a manner which will not create odors, unsightliness or other nuisances.
 2. The face of the working fill must be kept as narrow as is consistent with safe and efficient operation of equipment.
 3. Bulky waste material which may provide for the harborage of rodents must not be used for the final surface of side slopes.
 4. The solid wastes must be spread and compacted in thin layers. In the construction of each cell it must be spread into layers that do not exceed 2 feet before compaction. Equipment for compaction must be appropriately sized and must make a minimum of two passes over each layer of waste.
 5. Solid waste must not be placed within 200 feet of the boundary line of a Class I site unless a shorter distance is approved by the solid waste management authority. In approving a setback of less than 200 feet, the solid waste management authority shall consider the uses of the surrounding land, the surrounding topography and the operations conducted at the site.
- [Environmental Comm'n, Solid Waste Mgt Reg. §§ 5.1.3.1-5.1.3.4, eff. 9-21-77]—(NAC A 9-2-92; 11-8-93)

NAC 444.688 Covering of compacted solid waste; continuous operation as alternative. ([NRS 444.560](#))

1. The compacted solid waste of a Class I site must be covered as follows:
 - (a) Except as otherwise provided in this section, solid waste that is disposed of at the Class I site must be covered at the end of each operating day or at more frequent intervals as necessary to control disease vectors, fires, odors, blowing litter and scavenging with at least 6 inches of compacted earthen material.
 - (b) The solid waste management authority may approve alternative materials to be used for compaction and alternative thicknesses of that material if the owner or operator shows that the alternative materials and thicknesses are capable of controlling disease vectors, fires, odors, blowing litter and scavenging without presenting a threat to public health and safety and the environment.
 - (c) The solid waste management authority may grant a temporary waiver from the requirements of paragraphs (a) and (b) if the owner or operator can show that extreme seasonal climatic conditions make the requirements impractical.
 - (d) Unless otherwise approved by the solid waste management authority, at least 12 inches of compacted earthen material must be placed as an intermediate cover on a fill surface if that surface is not to receive waste for more than 90 days. This paragraph does not apply to final fill surfaces.
 - (e) The integrity of daily and intermediate cover must be maintained until further filling or the addition of final cover is made. All cracks, depressions and erosion of the cover for surface and side slopes of fills must be promptly repaired.
 - (f) Daily and temporary cover must be graded to drain runoff of surface water. The top slope must have a grade of not less than 3 percent.
2. The solid waste management authority may approve the continuous operation of a Class I site as an alternative to the requirements of subsection 1 if the owner or operator shows that its plan for the continuous operation of the site is sufficient to control disease vectors, fires, odors, blowing litter and scavenging without presenting a threat to public health and safety and the environment.
3. As used in this section:
 - (a) "Continuous operation" means that at all times throughout each 24-hour period:
 - (1) Waste is being received, placed, spread or compacted on the working surface of the site; and
 - (2) At least one piece of heavy equipment is operating on the working surface of the site to spread or compact the waste.
 - (b) "Operating day" means the portion of a day during which a site is accepting or managing solid waste.

[Environmental Comm'n, Solid Waste Mgt Reg. §§ 5.1.3.5.1-5.1.3.5.5, eff. 9-21-77]—(NAC A 9-2-92; 11-8-93; R034-98, 4-17-98; R179-05, 1-30-2008, eff. 4-1-2008)

NAC 444.6885 System to control runoff and runoff. ([NRS 444.560](#))

1. The owner or operator of a Class I site shall provide a system to control runoff and runoff.
 2. The owner or operator of a Class I site shall design, construct and maintain:
 - (a) A system to control runoff to prevent flow onto the active portion of the landfill during the peak discharge from a 25-year storm; and
 - (b) A system to control runoff from the active portion of the landfill to collect and control at least the volume of water resulting from a 24-hour, 25-year storm, as those durations and frequencies for storms are defined in the "Precipitation Frequency Atlas of the Western United States," vol. VII-Nevada, prepared by the National Weather Service and National Oceanic and Atmospheric Administration, United States Department of Commerce. The publication may be obtained from the Hydrometeorological Design Studies Center, Office of Hydrology, National Weather Service, 1325 East-West Highway, Silver Spring, Maryland 20910, at a cost of \$9.
 3. Runoff from the active portion of the landfill must be handled in accordance with [NAC 444.6887](#).
 4. As used in this section, "active portion" means that part of a municipal solid waste landfill unit which has received or is receiving wastes and which has not been closed in accordance with [NAC 444.6891](#), [444.6892](#) and [444.6893](#).
- (Added to NAC by Environmental Comm'n, eff. 11-8-93; A by R202-97, 3-5-98)

NAC 444.6887 Discharge of pollutants or contaminants into surface waters prohibited. ([NRS 444.560](#)) The owner or operator of a Class I site shall not:

1. Cause a discharge of pollutants or contaminants from a municipal solid waste landfill unit into the waters of the State or waters of the United States, including wetlands, which violates any requirements of the federal Clean Water Act of 1977, including, but not limited to, the National Pollutant Discharge Elimination System, 33 U.S.C. § 1342, as that section existed on November 8, 1993, or [NRS 445A.300](#) to [445A.730](#), inclusive, and the regulations adopted pursuant thereto; or
 2. Cause the discharge of a nonpoint source of pollution into the waters of the State or waters of the United States, including wetlands, which violates any requirement of a plan for the management of the quality of water that is applicable in the area or throughout the State and which has been approved pursuant to sections 208 or 319 of the Clean Water Act of 1977, 33 U.S.C. §§ 1288 or 1329, as those sections existed on November 8, 1993, or [NRS 445A.300](#) to [445A.730](#), inclusive, and the regulations adopted pursuant thereto.
- (Added to NAC by Environmental Comm'n, eff. 11-8-93)

NAC 444.6891 Requirements for design and construction of system for final cover. ([NRS 444.560](#))

1. The owner or operator of a Class I site shall install a system for a final cover which is designed to minimize infiltration and erosion. Except as otherwise provided in subsection 2, the system must be designed and constructed to:
 - (a) Have a permeability that is less than or equal to the permeability of any system for a bottom liner or natural subsoils present, or have a permeability no greater than 1×10^{-5} centimeters per second, whichever is less;
 - (b) Minimize infiltration through the closed municipal solid waste landfill unit by the use of an infiltration layer which contains at least 18 inches of earthen material; and
 - (c) Minimize erosion of the final cover by the use of an erosion layer which contains at least 6 inches of earthen material which is capable of sustaining the growth of native plants.
2. The solid waste management authority may approve an alternative design for a final cover which includes:
 - (a) An infiltration layer which achieves an equivalent reduction in infiltration as the infiltration layer specified in paragraphs (a) and (b) of subsection 1; and
 - (b) An erosion layer which provides equivalent protection from wind and water erosion as the erosion layer specified in paragraph (c) of subsection 1.
3. The final cover must be graded to drain surface water from the cover. The top slope must have a grade of not less than 3 percent. The design of the final cover must be sufficient to control erosion and maintain the

stability of the slope.

(Added to NAC by Environmental Comm'n, eff. 11-8-93)

NAC 444.6892 Notice of intent to close; general requirements concerning closure. ([NRS 444.560](#))

1. At least 15 days before beginning the closure of a municipal solid waste landfill unit at a Class I site pursuant to subsection 2, an owner or operator shall provide notice to the solid waste management authority of the intent to close the unit.

2. The owner or operator shall begin activities for the closure of the municipal solid waste landfill unit no later than 30 days after the date on which the unit receives the final receipt of wastes or, if the unit has remaining capacity and there is a reasonable likelihood that the unit will receive additional wastes, no later than 1 year after the most recent receipt of wastes. Extensions beyond the 1-year deadline may be granted by the solid waste management authority if the owner or operator demonstrates that the unit has the capacity to receive additional wastes and the owner or operator has taken and will continue to take all actions necessary to prevent threats to public health and safety and the environment from the open unit.

3. Except as otherwise provided in subsections 4 and 5, the owner or operator of a Class I site shall complete activities for the closure of each municipal solid waste landfill unit at the site in accordance with the plan for closure within 180 days after the beginning the closure. Extensions of the period for closure may be granted by the solid waste management authority if the owner or operator demonstrates that closure will, of necessity, take longer than 180 days and that the owner or operator has taken and will continue to take all actions to prevent threats to public health and safety and the environment from the open unit.

4. The owner or operator of a Class I site which stopped receiving waste before November 8, 1993, shall:

(a) Comply with the requirements for a final cover set forth in [NAC 444.6891](#); and

(b) Complete activities for the closure of each municipal solid waste landfill unit at the site by May 8, 1994.

5. The owner or operator of an existing municipal solid waste landfill unit or lateral expansion at a Class I site which accepts less than 100 tons of solid waste per day shall, if the site stops receiving waste before April 9, 1994:

(a) Comply with the requirements for a final cover set forth in [NAC 444.6891](#); and

(b) Complete activities for the closure of each municipal solid waste landfill unit at the site within 180 days after the last receipt of waste.

6. After the closure of each municipal solid waste landfill unit, the owner or operator of the site shall notify the solid waste management authority that a certification, signed by an independent licensed professional engineer and approved by the solid waste management authority verifying that closure has been completed in accordance with the plan for closure, has been placed in the operating record of the site.

(Added to NAC by Environmental Comm'n, eff. 11-8-93; A 3-1-94)

NAC 444.6893 Requirements after closure of all municipal solid waste landfill units within Class I site. ([NRS 444.560](#))

1. After the closure of all municipal solid waste landfill units within a Class I site, the owner or operator of the site shall:

(a) Record a notation that complies with the requirements of subsection 2 on the deed to the property on which the site is located or on any other instrument which is normally examined during a title search; and

(b) Notify the solid waste management authority that the notation has been recorded and a copy of the notation has been placed in the operating records of the site.

2. The notation on the deed or other instrument must in perpetuity notify any potential purchaser of the property that:

(a) The land has been used as a landfill; and

(b) Its use is restricted in accordance with [NAC 444.6896](#).

3. The owner or operator may request permission from the solid waste management authority to remove the notation from the deed or other instrument if all wastes are removed from the site.

(Added to NAC by Environmental Comm'n, eff. 11-8-93)

NAC 444.6894 Program for postclosure for each municipal solid waste landfill unit within Class I site. ([NRS 444.560](#))

1. After the closure of each municipal solid waste landfill unit of a Class I site, the owner or operator of the site shall conduct a program for postclosure for that unit. Except as otherwise provided in subsection 2, the program must be conducted for 30 years and consist of at least the following:

(a) The integrity and effectiveness of any final cover must be maintained, including making repairs to the cover as necessary to correct the effects of settlement, subsidence, erosion or other events, and preventing runoff and runoff from eroding or otherwise damaging the final cover.

(b) The system to collect leachate must be maintained and operated in accordance with the requirements in [NAC 444.681](#), if applicable. The solid waste management authority may allow the owner or operator to stop managing leachate if the owner or operator demonstrates that leachate no longer poses a threat to public health and safety and the environment.

(c) The groundwater must be monitored in accordance with [NAC 444.7481](#) to [444.7499](#), inclusive, and the system for monitoring the groundwater must be maintained, if applicable.

(d) The system for monitoring gas must be maintained and operated in accordance with [NAC 444.667](#).

2. The length of the program for postclosure may be:

(a) Decreased by the solid waste management authority if the owner or operator demonstrates that the reduced period is sufficient to protect public health and safety and the environment and this demonstration is approved by the solid waste management authority; or

(b) Increased by the solid waste management authority if it determines that the lengthened period is necessary to protect public health and safety and the environment.

3. After the completion of the program for postclosure for each municipal solid waste landfill unit at a Class I site, the owner or operator shall notify the solid waste management authority that a certification, signed by an independent licensed professional engineer and approved by the solid waste management authority verifying that the program has been completed in accordance with the plan for postclosure, has been placed in the operating record.

(Added to NAC by Environmental Comm'n, eff. 11-8-93)

NAC 444.6895 Plan for final cover or closure of Class I site. ([NRS 444.560](#)) A plan for closing a Class I site must include:

1. A description of the actions necessary to close all municipal solid waste landfill units within the site at any time during their active life;

2. A description of the final cover required by [NAC 444.6891](#), [444.6892](#) and [444.6893](#);

3. An estimate of the largest area of the municipal solid waste landfill unit which would require final cover at any time during the active life of the unit if the site is closed;

4. An estimate of the total maximum inventory of wastes to be placed on the disposal site during the entire estimated life of the site;

5. The equipment and structures for the removal of wastes, decommissioning and decontamination;

6. The placement and installation of devices to monitor or control water, vadose zone and landfill gases, if necessary; and

7. A schedule for completing all construction and related activities needed to close the disposal site in accordance with [NAC 444.6891](#), [444.6892](#) and [444.6893](#).

(Added to NAC by Environmental Comm'n, eff. 11-8-93)

NAC 444.6896 Plan for postclosure; use of property during or after period of postclosure. ([NRS 444.560](#))

1. A plan for postclosure which specifies how and at what frequency a municipal solid waste landfill unit will be maintained and monitored during the period of postclosure must include:

(a) A program for monitoring water which complies with the requirements of [NAC 444.7481](#) to [444.7499](#), inclusive;

(b) A program for the inspection and maintenance of:

(1) The final cover;

(2) Structures for drainage and protection from floods; and

- (3) Systems for monitoring and controlling landfill gases;
- (c) The name, address and telephone number of the person or office to contact about the unit during the period of postclosure;
- (d) A description of the planned uses of the property during the period of postclosure; and
- (e) Any other information which the solid waste management authority may require.
2. Any use of the property during or after the period of postclosure must not disturb the integrity of the final cover, liners, any other components of the system for containment or the function of the monitoring system unless necessary to comply with the requirements of [NAC 444.570](#) to [444.7499](#), inclusive.
(Added to NAC by Environmental Comm'n, eff. 11-8-93; A 3-1-94)

NAC 444.6897 Maintenance of plans for closure and postclosure in operating records of site. ([NRS 444.553](#), [444.560](#)) The owner or operator of a Class I site shall maintain a copy of the plans for closure and postclosure in the operating records of the site. To receive a permit to operate the disposal site, the plans for closure and postclosure must be placed in the operating records of the disposal site by November 8, 1993, or by the initial receipt of waste, whichever is later. The owner or operator shall notify the solid waste management authority immediately upon placing the plans in its operating records. The owner or operator shall include the plans for closure and postclosure in his or her application for a permit to operate the site.
(Added to NAC by Environmental Comm'n, eff. 11-8-93)

NAC 444.690 Signs. ([NRS 444.560](#)) Signs must be posted that clearly indicate:

1. The owner and operator of the site.
2. The hours of operation.
3. Materials accepted or excluded.
4. Fees charged.

[Environmental Comm'n, Solid Waste Mgt Reg. §§ 5.1.3.18.1-5.1.3.18.4, eff. 9-21-77]

NAC 444.692 Disposal of liquids. ([NRS 444.560](#))

1. An owner or operator of a Class I site shall restrict the types and amounts of liquids disposed of in a Class I site except as permitted by the solid waste management authority in accordance with subsections 2 and 3.

2. Liquids which are in bulk or not in containers may not be placed in a municipal solid waste landfill unit unless:

(a) The waste is household waste other than septic waste; or

(b) The waste is leachate or gas condensate from the municipal solid waste landfill unit and the new or existing unit or lateral expansion is designed with a composite liner and system for the collection of leachate as described in [NAC 444.681](#).

3. Containers holding liquid waste may not be placed in a municipal solid waste landfill unit unless:

(a) The container is a small container similar in size to a container which would normally be found in household waste;

(b) The container is designed to hold liquids for use other than storage; and

(c) The liquid waste is household waste.

4. As used in this section, "liquid waste" means any waste material which is determined to contain free liquids as a result of a paint filter liquids test, Method 9095, described in *Test Methods for Evaluating Solid Waste, Physical/Chemical Methods*, Environmental Protection Agency, Publication No. SW-846, as adopted by reference in [NAC 444.636](#).

[Environmental Comm'n, Solid Waste Mgt Reg. § 5.1.3.12, eff. 9-21-77]—(NAC A 9-2-92; 11-8-93; 11-9-95; R202-97, 3-5-98)

NAC 444.694 Putrescible wastes; vector control. ([NRS 444.560](#))

1. Any dead animals, carrion, slaughterhouse wastes and other highly putrescible wastes accepted at the land disposal site must be placed in a separate trench or area and covered immediately.

2. Vector control must be instituted, whenever necessary in the judgment of the solid waste management

authority, to minimize transmission of disease.

[Environmental Comm'n, Solid Waste Mgt Reg. §§ 5.1.3.13 & 5.1.3.14, eff. 9-21-77]

NAC 444.696 Control of erosion and dust. ([NRS 444.560](#))

1. Suitable grasses must be planted, as required, in completed areas of the landfill to prevent erosion, surface deterioration and fugitive dust.

2. Adequate water must be available at all times for dust control and for compaction of cover material.

[Environmental Comm'n, Solid Waste Mgt Reg. §§ 5.1.3.5.6 & 5.1.3.6, eff. 9-21-77]

NAC 444.698 Access; roads. ([NRS 444.560](#))

1. Access to a municipal solid waste landfill unit must be controlled as to time of use and as to those authorized to use the site in order to prevent unauthorized vehicular traffic and illegal dumping. Access must be controlled by using artificial or natural barriers, or both, as appropriate, to protect public health and safety and the environment. An attendant must be on duty to control access during hours of operation.

2. Permanent roads may be provided from the public road system to the site. Temporary roads may be provided as necessary to the working face. All roads must be passable during inclement weather.

[Environmental Comm'n, Solid Waste Mgt Reg. §§ 5.1.3.11 & 5.1.3.16, eff. 9-21-77]—(NAC A 11-8-93)

NAC 444.700 Facilities for personnel. ([NRS 444.560](#)) Suitable shelter and sanitary facilities must be provided for operating personnel and waste transport personnel.

[Environmental Comm'n, Solid Waste Mgt Reg. § 5.1.3.10, eff. 9-21-77]

NAC 444.702 Miscellaneous requirements for operation; quarterly reports; topographic or other volumetric surveys and reports. ([NRS 444.560](#))

1. Scavenging at a Class I site is prohibited.

2. Salvaging is prohibited at the working face of a Class I site.

3. A Class I site must be inspected daily and all scattered paper and other lightweight debris returned to the fill area and covered.

4. The operator of a Class I site shall establish provisions concerning weighing or otherwise adequately measuring and recording all solid waste delivered to the site.

5. The operation of a Class I site must be approved by the solid waste management authority.

6. The operator of a Class I site shall submit quarterly to the Division a report of the solid waste received at the site. The report must be submitted on a form prescribed by the Division.

7. The operator of a Class I site shall, on or before January 1, 2004, and at least once every 5 years thereafter until the site is closed in accordance with [NAC 444.6891](#), [444.6892](#) and [444.6893](#), conduct a topographic survey, or other volumetric survey approved by the solid waste management authority, of the site and submit a report to the solid waste management authority. Except as otherwise provided in this subsection, each such report must be submitted not later than 5 years after the date on which the immediately preceding report was submitted. Each report must:

(a) Be signed by a professional engineer registered in this State;

(b) Be at a scale of not more than 200 feet to the inch, including contour intervals of not more than 5 feet;

(c) Show the current topography of the site;

(d) Indicate the remaining volume and disposal capacity of the site;

(e) Indicate the volume used and waste disposed of since the original report of design; and

(f) Calculate the remaining life of the site, in years.

[Environmental Comm'n, Solid Waste Mgt Reg. §§ 5.1.3.7-5.1.3.9, 5.1.3.15 & 5.1.3.17, eff. 9-21-77]—(NAC A 9-2-92; R105-02, 10-18-2002)

NAC 444.7025 Operating records required to be kept; notice to solid waste management authority. ([NRS 444.560](#))

1. The owner or operator of a Class I site shall record and retain at the site in the operating records or at a location approved by the solid waste management authority, the following information as it becomes

available:

- (a) Any demonstration of restrictions on location required by [NAC 444.678](#) to [444.6795](#), inclusive;
- (b) Records of inspection, training procedures and procedures for notification required by [NAC 444.6665](#);
- (c) Results from the monitoring of gas and any remediation plans required by [NAC 444.667](#);
- (d) Any documentation relating to the design of the municipal solid waste landfill unit for the placement of leachate or gas condensate in the unit as required by paragraph (b) of subsection 2 of [NAC 444.692](#);
- (e) Any demonstration, certification, finding, monitoring, testing or analytical data from the program for monitoring groundwater required by [NAC 444.7481](#) to [444.7499](#), inclusive;
- (f) Plans for closure and postclosure and any monitoring, testing or analytical data required by [NAC 444.6891](#) to [444.6896](#), inclusive; and
- (g) Any documentation of cost estimates and financial assurance required by [NAC 444.685](#).

2. The owner or operator shall notify the solid waste management authority when the documentation has been placed in or added to the operating records. All information contained in the operating records must be furnished upon request to the solid waste management authority or be made available at all reasonable times for inspection by the solid waste management authority.

3. The solid waste management authority may establish alternative schedules for recordkeeping and notification required by [NAC 444.570](#) to [444.7499](#), inclusive, except for the notification required by paragraph (c) of subsection 1 of [NAC 444.6783](#) and by subsection 3 of [NAC 444.7491](#).

(Added to NAC by Environmental Comm'n, eff. 11-8-93; A 3-1-94)

Class II Sites

NAC 444.704 Minimum requirements; operating records; contamination of groundwater. ([NRS 444.560](#))

1. All Class II sites must comply with the minimum requirements set forth in this section and [NAC 444.706](#) to [444.728](#), inclusive. A Class II site which fails to satisfy the minimum requirements shall be deemed to be an open dump for the purpose of the disposal of solid waste and is prohibited.

2. The owner or operator of a new or existing municipal solid waste landfill unit or a lateral expansion which meets the criteria for a Class II site pursuant to [NAC 444.571](#) shall place in the operating records of the unit such information as necessary to demonstrate how the unit or lateral expansion meets the criteria.

3. An owner or operator of a new or existing municipal solid waste landfill unit or a lateral expansion which meets the criteria for a Class II site who has knowledge that the unit or lateral expansion has contaminated the groundwater shall:

(a) Notify the solid waste management authority of the contamination; and

(b) Comply with the requirements for a Class I site set forth in [NAC 444.645](#), [444.6665](#) to [444.6678](#), inclusive, [444.6765](#) to [444.7025](#), inclusive, and [444.7481](#) to [444.7499](#), inclusive.

[Environmental Comm'n, Solid Waste Mgt Reg. § 5.2, eff. 9-21-77]—(NAC A 9-2-92; 11-8-93)

NAC 444.7045 Provisions for employees; compliance with certain provisions; deviations. ([NRS 444.560](#))

1. The owner or operator of a Class II site shall provide suitable shelter, drinking water and sanitary facilities for the employees who work at the Class II site.

2. Except as otherwise provided in subsection 3, the owner or operator of a Class II site shall comply with:

(a) [NAC 444.6895](#), for the closure of the municipal solid waste landfill units;

(b) [NAC 444.6894](#) and [444.6896](#), for the postclosure maintenance of municipal solid waste landfill units;

(c) [NAC 444.685](#) to [444.6859](#), inclusive;

(d) [NAC 444.6665](#) to [444.6678](#), inclusive, [444.6885](#), [444.6887](#), [444.692](#), [444.698](#) and [444.7025](#), if the Class II site contains at least one municipal solid waste landfill unit;

(e) [NAC 444.6765](#) and [444.678](#) to [444.6795](#), inclusive; and

(f) [NAC 444.6891](#), [444.6892](#) and [444.6893](#).

3. The solid waste management authority may, after public review and comment, allow the owner or operator to deviate from the provisions concerning the infiltration barrier set forth in [NAC 444.6891](#). In

deciding whether to allow the deviation, the solid waste management authority shall consider:

- (a) The unique characteristics of small communities;
- (b) Climatic and hydrogeologic conditions; and
- (c) Whether allowing the deviation would have an adverse effect on human health or the environment.

(Added to NAC by Environmental Comm'n, 11-8-93, eff. 10-9-95; A 3-1-94; 11-9-95, eff. 10-9-97; R034-98, 4-17-98)

NAC 444.705 Application for permit to operate Class II site or lateral expansion thereof. ([NRS 444.553](#), [444.556](#), [444.560](#)) An application for a permit to operate a Class II site or a lateral expansion of a Class II site must be submitted to the solid waste management authority and must include:

1. The name, location and mailing address of the:
 - (a) Site;
 - (b) Owner of the site;
 - (c) Operator of the site; and
 - (d) Authorized agent of the owner.
2. Proof of ownership of the land on which the site will be located.
3. The report for the design of the site required by [NAC 444.708](#).
4. The plan for operating the site required by [NAC 444.712](#).
5. The plan for closing the site, the plan for postclosure and the documentation of the financial assurance required by [NAC 444.704](#).

(Added to NAC by Environmental Comm'n, eff. 9-2-92; A 11-8-93; 10-3-96)

NAC 444.706 Location. ([NRS 444.560](#)) The location of a Class II site must:

1. Not be within one-half mile of the nearest inhabited dwelling or place of public gathering or within 1,000 feet of a public highway, unless special provisions for the beautification of the site and the control of litter and vectors are included in the design and approved by the solid waste management authority.

2. Meet with the approval of the solid waste management authority.
[Environmental Comm'n, Solid Waste Mgt Reg. §§ 5.2.1.1-5.2.1.7, eff. 9-21-77]—(NAC A 9-2-92; 11-8-93)

NAC 444.708 Report for design. ([NRS 444.560](#)) The report for the design of a Class II site must include a design that:

1. Is intended to protect the waters of the State from degradation by pollutants or contaminants; and
2. Complies with the requirements set forth in subsections 1 to 7, inclusive, of [NAC 444.680](#).

[Environmental Comm'n, Solid Waste Mgt Reg. §§ 5.2.2.2-5.2.2.3.8, eff. 9-21-77]—(NAC A 9-2-92; 11-8-93)

NAC 444.711 Required installation of certain systems. ([NRS 444.560](#)) The solid waste management authority may require the owner or operator of a Class II site to install:

1. A system for monitoring groundwater which complies with the provisions of [NAC 444.7483](#); or
2. A system for monitoring moisture in the unsaturated zone,

if the solid waste management authority determines that the system is necessary to protect the waters of the State from degradation by pollutants or contaminants.

(Added to NAC by Environmental Comm'n, eff. 11-8-93; A 3-1-94; 11-9-95; 10-3-96)

NAC 444.712 Plan for operating. ([NRS 444.560](#)) The plan for operating a Class II site must:

1. Comply with subsections 1, 2 and 4 of [NAC 444.684](#); and
2. Demonstrate how the site will comply with [NAC 444.6665](#) to [444.6678](#), inclusive, and [444.714](#) to [444.728](#), inclusive.

[Environmental Comm'n, Solid Waste Mgt Reg. §§ 5.2.2.6-5.2.2.9, eff. 9-21-77]—(NAC A 9-2-92; 11-8-93)

NAC 444.714 Operation and maintenance. ([NRS 444.560](#)) The operation and maintenance of a Class II site must be in accordance with [NAC 444.686](#).
[Environmental Comm'n, Solid Waste Mgt Reg. §§ 5.2.3.1-5.2.3.4, eff. 9-21-77]—(NAC A 9-2-92; 11-8-93)

NAC 444.716 Cover of solid wastes. ([NRS 444.560](#))

1. Except as otherwise provided in subsection 2, solid wastes at a Class II site must be covered in accordance with [NAC 444.688](#).

2. The solid waste management authority may, after public review and comment, allow the owner or operator of a Class II site to cover solid waste less frequently than set forth in [NAC 444.688](#). In deciding whether to allow the deviation, the solid waste management authority shall consider:

- (a) The unique characteristics of small communities;
- (b) Climatic and hydrogeologic conditions; and
- (c) Whether allowing the deviation would have an adverse effect on human health or the environment.

[Environmental Comm'n, Solid Waste Mgt Reg. §§ 5.2.3.5.1-5.2.3.5.4, eff. 9-21-77]—(NAC A 9-2-92; 11-8-93, eff. 10-9-95; 11-9-95, eff. 10-9-97; R034-98, 4-17-98)

NAC 444.7175 Final cover and closure for certain sites; deviations. ([NRS 444.560](#))

1. The owner or operator of a Class II site that stops receiving waste before October 9, 1997, shall:

(a) Except as otherwise provided in subsection 2, comply with the requirements for a final cover set forth in [NAC 444.6891](#); and

(b) Complete activities for the closure of each municipal solid waste landfill unit at the site within 180 days after the last receipt of waste.

2. The solid waste management authority may, after public review and comment, allow the owner or operator to deviate from the provisions concerning the infiltration barrier set forth in [NAC 444.6891](#). In deciding whether to allow the deviation, the solid waste management authority shall consider:

- (a) The unique characteristics of small communities;
- (b) Climatic and hydrogeologic conditions; and
- (c) Whether allowing the deviation would have an adverse effect on human health or the environment.

(Added to NAC by Environmental Comm'n, eff. 11-8-93; A 3-1-94; 11-9-95; R034-98, 4-17-98)

NAC 444.718 Signs. ([NRS 444.560](#)) Signs must be posted that clearly indicate:

1. The owner and operator of the site.
2. The hours of operation.
3. Materials accepted or excluded.
4. Fees charged.

[Environmental Comm'n, Solid Waste Mgt Reg. §§ 5.2.3.14-5.2.3.14.4, eff. 9-21-77]

NAC 444.720 Disposal of special wastes. ([NRS 444.560](#)) Sewage solids or liquids and other special wastes must not be disposed of in a Class II site except when special permission has been given by the solid waste management authority.

[Environmental Comm'n, Solid Waste Mgt Reg. § 5.2.3.8, eff. 9-21-77]—(NAC A 9-2-92)

NAC 444.722 Putrescible wastes; vector control. ([NRS 444.560](#))

1. Any dead animals, carrion, slaughterhouse wastes or other highly putrescible wastes accepted at the land disposal site must be placed in a separate trench or area and covered immediately.

2. Vector control must be instituted, whenever necessary in the judgment of the solid waste management authority, to minimize transmission of disease.

[Environmental Comm'n, Solid Waste Mgt Reg. §§ 5.2.3.9 & 5.2.3.10, eff. 9-21-77]

NAC 444.724 Control of erosion and dust. ([NRS 444.560](#)) Suitable grasses must be planted, as required, in completed areas of the landfill to prevent erosion, surface deterioration and fugitive dust.

[Environmental Comm'n, Solid Waste Mgt Reg. § 5.2.3.5.5, eff. 9-21-77]

NAC 444.726 Roads. ([NRS 444.560](#))

1. Permanent roads should be provided from the public road system to the site.
2. Temporary roads may be provided as necessary to the working face.
3. All roads must be passable during normal inclement weather.

[Environmental Comm'n, Solid Waste Mgt Reg. § 5.2.3.12, eff. 9-21-77]

NAC 444.728 Miscellaneous requirements for operation; semiannual reports; topographic or other volumetric surveys and reports. ([NRS 444.560](#))

1. Salvaging is prohibited at the working face of a Class II site. Scavenging is prohibited at a Class II site.

2. A Class II site must be inspected semiweekly and all scattered papers and other lightweight debris returned to the fill area and covered.

3. The operator of a Class II site shall establish provisions concerning weighing or otherwise adequately measuring and recording all solid waste delivered to the site.

4. The operation of a Class II site must be approved by the solid waste management authority.

5. The operator of a Class II site shall:

(a) Comply with the requirements relating to the maintenance and operation of the site set forth in 40 C.F.R. Parts 258.20 to 258.29, inclusive, effective October 9, 1997.

(b) Submit semiannually to the Division a report of the solid waste received at the site. The report must be submitted on a form prescribed by the Division.

(c) On or before January 1, 2004, and at least once every 5 years thereafter until the site is closed in accordance with [NAC 444.6891](#), [444.6892](#) and [444.6893](#), conduct a topographic survey, or other volumetric survey approved by the solid waste management authority, of the site and submit a report to the solid waste management authority. Except as otherwise provided in this paragraph, each such report must be submitted no later than 5 years after the date on which the immediately preceding report was submitted. Each report must:

(1) Be signed by a professional engineer registered in this State;

(2) Be at a scale of not more than 200 feet to the inch, including contour intervals of not more than 5 feet;

(3) Show the current topography of the site;

(4) Indicate the remaining volume and disposal capacity of the site;

(5) Indicate the volume used and waste disposed of since the original report of design; and

(6) Calculate the remaining life of the site, in years.

[Environmental Comm'n, Solid Waste Mgt Reg. §§ 5.2.3.6, 5.2.3.7, 5.2.3.11 & 5.2.3.13, eff. 9-21-77]—
(NAC A 9-2-92; 11-9-95; R105-02, 10-18-2002)

Class III Sites

NAC 444.731 Minimum standards; reduction or waiver of requirements. ([NRS 444.560](#))

1. Except as otherwise provided in subsections 2 and 3, each Class III site must comply with the standards for location, design, construction, operation and maintenance set forth in [NAC 444.733](#) to [444.747](#), inclusive.

2. A solid waste management authority may adopt less restrictive standards for a Class III site which receives waste material which is inert or unlikely to create an environmental hazard or threaten the health of the general public.

3. A solid waste management authority may waive the requirements for a Class III site if the owner or operator of that site demonstrates that:

(a) All waste which is placed in the landfill is incidental to his or her industrial operation;

(b) The landfill is located on property controlled by the operator of the industrial operation; and

(c) The landfill will not receive any hazardous materials and is unlikely to produce pollutants or contaminants that may degrade waters of the State.

4. An owner or operator who applies for a waiver must submit a plan to the solid waste management authority for approval. The plan must include:

- (a) A description of the type and estimated amount of material which will be placed in the landfill; and
- (b) A program for the maintenance of the site.

5. As used in this section, "hazardous material" has the meaning ascribed to it in [NRS 459.7024](#).

(Added to NAC by Environmental Comm'n, eff. 9-2-92; A 11-9-95)

NAC 444.733 Application for permit to operate Class III site or lateral expansion thereof. ([NRS 444.553](#), [444.560](#)) An application for a permit to operate a Class III site or a lateral expansion of a Class III site must be submitted to the solid waste management authority. Unless otherwise determined by the solid waste management authority, the application must include:

1. The name, location and mailing address of the:
 - (a) Site;
 - (b) Owner of the site;
 - (c) Operator of the site; and
 - (d) Authorized agent of the owner.
2. Proof of ownership of the land on which the site will be located.
3. The plan to characterize solid waste required by [NAC 444.737](#).
4. The report required by [NAC 444.739](#).
5. The plan for monitoring water required by [NAC 444.741](#).
6. The plan for operating the site required by [NAC 444.684](#).
7. The plan for closing the site which complies with [NAC 444.6895](#).
8. The plan for postclosure of the site which complies with [NAC 444.6896](#).
9. Documentation of financial assurance which complies with [NAC 444.685](#).

(Added to NAC by Environmental Comm'n, eff. 9-2-92; A 11-8-93)

NAC 444.735 Location. ([NRS 444.560](#)) The location of a Class III site must:

1. Be easily accessible in all kinds of weather to all vehicles expected to use it.
2. Safeguard against water pollution originating from the decomposed solid waste at the site.
3. Safeguard against uncontrolled movement or collection of gas originating from the decomposed waste at the site.

4. Have an adequate quantity of cover material that is workable, compactible and does not contain organic material of a quantity and distribution conducive to the harboring and breeding of disease vectors.

5. Conform to the land use planning of the area.

6. Not be within one-fourth mile of the nearest inhabited domestic dwelling or place of public gathering or be within 1,000 feet of a public highway, unless special provisions for the beautification of the site and the control of litter vectors are included in the design and approved by the solid waste management authority.

7. Not be within 1,000 feet of any surface water or be within 100 feet of the uppermost aquifer if the site is approved after September 2, 1992, unless approved by the solid waste management authority.

8. Be approved by the solid waste management authority.

9. If the site accepts hazardous waste from conditionally exempt small quantity generators as defined in 40 C.F.R. § 261.5, comply with the provisions of [NAC 444.6785](#) and [444.679](#).

(Added to NAC by Environmental Comm'n, eff. 9-2-92; A by R034-98, 4-17-98)

NAC 444.737 Plan to characterize solid waste. ([NRS 444.560](#)) A plan to characterize solid waste for a Class III site must be sufficient to:

1. Determine that the waste is not a hazardous waste;
2. Identify physical and chemical characteristics of the waste which may create an environmental hazard or threaten the health of the general public; and
3. Provide for the periodic characterization of the waste stream as needed.

(Added to NAC by Environmental Comm'n, eff. 9-2-92)

NAC 444.739 Report for design. ([NRS 444.560](#)) A report for the design of a Class III site must:

1. Be signed by a professional engineer registered in this State.
2. Include a general location map showing land use and zoning within 1 mile of the disposal site.
3. Include a topographic map of the area which must:
 - (a) Be at a scale of not more than 200 feet to the inch, including contour intervals of not more than 5 feet.
 - (b) Indicate the proposed fill areas.
 - (c) Indicate any proposed borrow areas.
 - (d) Indicate access roads.
 - (e) Indicate a typical cross section of a lift.
 - (f) Indicate grades for proper drainage of each lift.
 - (g) Indicate the placement of special devices for drainage and controlling gas, if required.
 - (h) Indicate fencing, equipment for shelter, facilities for employees and all other relevant data to indicate clearly that the landfill will be developed, operated and completed in an orderly manner.
4. Define anticipated types, quantities and sources of solid wastes to be disposed of at the site.
5. Demonstrate the design is sufficient to protect the waters of the State from degradation by pollutants or contaminants. The demonstration must consider, without limitation:
 - (a) The hydrogeologic characteristics of the site and surrounding area;
 - (b) The climatic factors of the area; and
 - (c) The volume and physical and chemical characteristics of predicted leachate generation.
6. Provide proof of compliance with the provisions relating to the runoff and control of surface water set forth in [NAC 444.6885](#) and [444.6887](#).
7. Define the source, type and quantity of cover material for the site.
(Added to NAC by Environmental Comm'n, eff. 9-2-92; A 11-8-93)

NAC 444.741 Plan for monitoring water; suspension of monitoring requirements. ([NRS 444.560](#))

1. A plan for monitoring water for a Class III site must provide for a system capable of monitoring the performance of the design of the site, including the monitoring of the unsaturated zone or groundwater depending on local conditions.
2. The plan must:
 - (a) Identify the location and construction of monitoring points to be used to detect the migration of pollutants or contaminants from the site to the waters of the State;
 - (b) Specify monitoring parameters and the frequency of monitoring those parameters;
 - (c) Specify procedures to ensure quality for all field and laboratory work;
 - (d) Provide for the semiannual submittal of monitoring data to the solid waste management authority;
 - (e) Define procedures which will be followed if monitoring provides evidence of potential design failure; and
 - (f) Comply with the provisions of [NAC 444.7481](#) to [444.7499](#), inclusive, if the plan includes the monitoring of groundwater.
3. The solid waste management authority may suspend monitoring requirements if the owner or operator of a Class III site demonstrates that there is no reasonable potential for migration of pollutants or contaminants from the site to waters of the State.
(Added to NAC by Environmental Comm'n, eff. 9-2-92; A 11-8-93)

NAC 444.743 Final cover or closure; postclosure. ([NRS 444.560](#)) A Class III site must comply with requirements set forth in [NAC 444.6891](#) to [444.6894](#), inclusive, concerning closure and postclosure.
(Added to NAC by Environmental Comm'n, eff. 9-2-92; A 11-8-93)

NAC 444.745 Control of erosion and dust. ([NRS 444.560](#))

1. Suitable grasses must be planted at a Class III site, if required, in completed areas of the landfill to prevent erosion, surface deterioration and fugitive dust.
2. The operator of the site shall ensure that an adequate amount of water is available at all times for the control of dust and the compaction of cover material.
(Added to NAC by Environmental Comm'n, eff. 9-2-92)

NAC 444.747 Miscellaneous requirements; reports; records; notification. ([NRS 444.560](#))

1. Scavenging at a Class III site is prohibited.
 2. The area of a Class III site must be inspected daily and all scattered paper and other lightweight debris returned to the fill area and covered.
 3. The operator of a Class III site shall:
 - (a) Establish provisions concerning weighing or otherwise adequately measuring and recording all solid waste received at the site; and
 - (b) Submit annually to the Division a report of the solid waste received at the site. The report must be submitted on a form provided by the Division within 30 days following the end of each calendar year.
 4. The operation of a Class III site must be approved by the solid waste management authority.
 5. The owner or operator of a Class III site shall record and retain in its operating records at its site or at another location approved by the solid waste management authority:
 - (a) Any documentation of cost estimates and financial assurance required pursuant to [NAC 444.685](#);
 - (b) Plans for closure and postclosure care and any monitoring, testing or analytical data required pursuant to [NAC 444.6891](#) to [444.6896](#), inclusive;
 - (c) How the site conforms to the restrictions on location set forth in [NAC 444.735](#);
 - (d) Any plan to characterize solid waste required pursuant to [NAC 444.737](#); and
 - (e) Any demonstration, certification, finding, monitoring, testing or analytical data from the program for monitoring groundwater required pursuant to [NAC 444.7481](#) to [444.7499](#), inclusive.
 6. The owner or operator shall promptly notify the solid waste management authority after the owner or operator has placed the information in the operating record of its facility pursuant to subsection 5. The information must be furnished upon request to the solid waste management authority or be made available for inspection by the solid waste management authority at any reasonable time.
 7. Notwithstanding any other provision of this chapter, the solid waste management authority may establish alternative schedules for Class III sites for any recordkeeping and notification required pursuant to [NAC 444.570](#) to [444.7499](#), inclusive, except that the authority will not establish an alternative schedule for the notification required pursuant to subsection 3 of [NAC 444.7491](#).
- (Added to NAC by Environmental Comm'n, eff. 9-2-92; A by R034-98, 4-17-98)

Materials Recovery Facilities

NAC 444.7474 "Materials recovery facility" defined. ([NRS 444.560](#)) As used in [NAC 444.7474](#) to [444.74779](#), inclusive, unless the context otherwise requires, "materials recovery facility" means a solid waste management facility that provides for the extraction from solid waste of recyclable materials, materials suitable for use as a fuel or soil amendment, or any combination of those materials. The term does not include:

1. A facility that receives only recyclable materials that have been separated at the source of waste generation if further processing of the materials generates less than 10 percent waste residue by weight on an annual average;
2. A salvage yard for the recovery of used motor vehicle parts;
3. A facility that receives, processes or stores only concrete, masonry waste, asphalt pavement, brick, uncontaminated soil or stone for the recovery of recyclable materials; and
4. A facility that recovers less than 10 percent by weight of the recyclable material from the solid waste received on an annual average.

(Added to NAC by Environmental Comm'n by R173-99, eff. 2-9-2000)

NAC 444.74743 Approval needed for operation; submission of application before construction begins. ([NRS 444.560](#))

1. A person shall not operate a materials recovery facility unless the location, design and operating plans of the facility have been approved by the solid waste management authority.
2. An application to operate a materials recovery facility must be submitted to the solid waste management authority before construction of the facility begins.

(Added to NAC by Environmental Comm'n by R173-99, eff. 2-9-2000)

NAC 444.74747 Application to operate; application to modify. ([NRS 444.560](#))

1. An application to operate a materials recovery facility must include:

- (a) The name, location and mailing address of:
 - (1) The materials recovery facility;
 - (2) The owner of the materials recovery facility;
 - (3) The operator of the materials recovery facility; and
 - (4) The authorized agent of the owner.
- (b) Proof of ownership of the land on which the materials recovery facility will be located.
- (c) A report of the design of the materials recovery facility that complies with the provisions of [NAC 444.74751](#).
- (d) A plan for operating the materials recovery facility that complies with the provisions of [NAC 444.74755](#).
- (e) A plan for the closure of the materials recovery facility that identifies the procedures required to close the facility and describes the manner in which the facility will comply with the provisions for closure set forth in [NAC 444.74771](#). The plan must include a detailed written estimate, in current dollars, of the cost to hire a person to close the materials recovery facility in accordance with the plan.
- (f) Proof of financial assurance that complies with the provisions of [NAC 444.74775](#).
- (g) A list of the recyclable materials that will be recovered at the materials recovery facility.
- (h) A description of the final use, or the available markets, for the materials identified for recovery.
- (i) Any other information that the solid waste management authority requires to evaluate the proposed operation of the facility.

2. A materials recovery facility that has been approved by the solid waste management authority may not modify:

- (a) The storage or processing capacity of the facility;
- (b) The types of waste that a facility may accept; or
- (c) The design or method of operation of the facility,

unless the facility obtains the prior approval of the solid waste management authority for those modifications. An application to modify a materials recovery facility must be submitted on a form prescribed by the solid waste management authority.

(Added to NAC by Environmental Comm'n by R173-99, eff. 2-9-2000)

NAC 444.74751 Report of design. ([NRS 444.560](#)) The report of the design of the materials recovery facility required by [NAC 444.74747](#) must:

1. Include a detailed description of the site of the facility, a diagram indicating the manner in which the materials are processed at the facility and the design capacity and environmental controls for the facility.
2. Be prepared under the direction of and signed and stamped by a professional engineer who is licensed in this State.
3. Include a general location map that indicates land use and zoning within 1 mile of the materials recovery facility.
4. Include plans and specifications of the materials recovery facility in sufficient detail to demonstrate compliance with the standards for the design of the facility set forth in [NAC 444.74759](#). The plans must:
 - (a) Be drawn to a scale of not more than 200 feet per inch;
 - (b) Indicate existing and proposed contours;
 - (c) Indicate access roads and traffic routes around and within the materials recovery facility;
 - (d) Include provisions for the control of surface water to minimize the contact of storm water with waste materials and to prevent pollutants or other contaminants from entering the waters of the State;
 - (e) Indicate fencing, areas for storing equipment, facilities for employees, areas for receiving and handling waste, maintenance areas and any other appurtenances;
 - (f) Include the maximum processing rate of the facility and the maximum storage capacity, in cubic yards, for processed and unprocessed waste and recovered materials;
 - (g) Include provisions for controlling odors and dust to prevent a public nuisance;
 - (h) Define the population and area that will be served by the materials recovery facility; and
 - (i) List the anticipated types, quantities and sources of solid waste that will be received at the materials

recovery facility.

(Added to NAC by Environmental Comm'n by R173-99, eff. 2-9-2000)

NAC 444.74755 Plan for operating. (NRS 444.560) The plan for operating the materials recovery facility required by [NAC 444.74747](#) must provide a detailed description of the proposed operating procedures and include, without limitation:

1. The provisions for controlling access to the materials recovery facility;
2. The number of persons who will be employed at the materials recovery facility during operating hours;
3. A list of the equipment and machinery that will be required to operate the materials recovery facility;
4. The procedures to control vehicular traffic within the materials recovery facility;
5. The types of wastes that the materials recovery facility will not accept and a list of the facilities where such waste will be directed;
6. A program to detect and reject regulated hazardous waste, polychlorinated biphenyl wastes or any other unacceptable wastes identified in the application;
7. The procedures for measuring or weighing solid waste that is accepted by the materials recovery facility;
8. The frequency and method for transferring solid waste to a disposal site;
9. The location of storage areas for processed and unprocessed solid wastes and recovered materials at the materials recovery facility;
10. A plan for the disposal of processed and unprocessed solid wastes and recovered materials;
11. The proposed operating hours of the materials recovery facility;
12. A contingency plan that describes the procedures for emergencies and identifies alternate solid waste management systems;
13. A description of the manner in which the materials recovery facility will comply with the provisions set forth in [NAC 444.74763](#); and
14. The safety procedures and protective equipment required for persons who handle solid waste at the materials recovery facility.

(Added to NAC by Environmental Comm'n by R173-99, eff. 2-9-2000)

NAC 444.74759 Standards for design. (NRS 444.560)

1. A materials recovery facility must be constructed with:
 - (a) Barriers and appurtenances necessary to control access to the facility;
 - (b) A road that provides access to the facility in all kinds of weather;
 - (c) Appurtenances to control litter;
 - (d) Provisions that screen the facility from the view of members of the general public;
 - (e) In areas where putrescible wastes will be received, processed or stored, a covered enclosure with at least three sides, and a floor with a durable surface that contains drainage controls to control runoff and prevent runoff or the accumulation of standing water; and
 - (f) In areas where solid wastes from the construction, refurbishment or demolition of buildings or other structures will be received, processed or stored, a floor with a durable surface that contains drainage controls to control runoff and prevent runoff or the accumulation of standing water.

2. A materials recovery facility that is open to the public must comply with the provisions relating to signs set forth in [NAC 444.690](#).

3. The design and location of a materials recovery facility must comply with applicable local ordinances.

(Added to NAC by Environmental Comm'n by R173-99, eff. 2-9-2000)

NAC 444.74763 Transfer, removal, recovery and storage of solid waste. (NRS 444.560)

1. Solid waste that is accepted by a materials recovery facility must be:
 - (a) Transferred to a disposal site that has been issued a permit by the solid waste management authority;
 or
 - (b) Recovered for reuse or recycling.
2. Unless the owner or operator is unable to do so because of an emergency, putrescible solid waste or

solid waste that is mixed with putrescible solid waste must be removed from a materials recovery facility not more than 72 hours after acceptance by the facility.

3. Nonputrescible solid waste may not be stored at the materials recovery facility for more than 1 week. Not more than 3,000 cubic yards of solid waste may be stored at the facility at one time, unless otherwise approved by the solid waste management authority.

4. Recovered materials may not be stored at the facility for more than 1 year. At least 75 percent of the materials recovered at the facility must be sold and removed from the facility in a 12-month period. Any recovered materials stored for more than 1 year must be considered waste and properly disposed of at a disposal site that has been issued a permit by the solid waste management authority or a facility approved by the solid waste management authority.

5. Solid waste or recovered materials may not be stored in piles which are more than 15 feet in height or have an area at the base which is more than 5,000 square feet. A distance of at least 12 feet must be maintained between adjacent piles of material and at least 10 feet between any pile of materials and the boundary of the facility.

6. The acceptance, handling and transportation of asbestos must be conducted in the manner prescribed by [NAC 444.965](#) to [444.976](#), inclusive.

7. The owner or operator of a materials recovery facility shall:

(a) Inspect the area of the facility daily and collect, and properly dispose of, all scattered paper and lightweight debris; and

(b) Comply, in accordance with the provisions of [NAC 444.660](#), with any local ordinances concerning the storage, collection or transportation of solid waste.

(Added to NAC by Environmental Comm'n by R173-99, eff. 2-9-2000)

NAC 444.74767 Maintenance, availability and content of records; classification of certain information as trade secret; reporting of recycled materials. ([NRS 444.560](#))

1. The operator of a materials recovery facility shall maintain accurate operating records at the facility. The records must be furnished upon request to the solid waste management authority or made available for inspection by the solid waste management authority during the regular business hours of the facility. The records must include:

(a) A daily record of:

(1) The quantity of solid waste received at the facility.

(2) The quantity of solid waste transported to disposal sites and the name and location of each such disposal site.

(3) The quantity of recovered materials removed from the facility and the name and location of each facility that receives the recovered materials.

(b) The receipt or rejection of prohibited wastes.

(c) Any emergencies or unusual events.

2. The operator of the facility may request that certain information included in the records be classified as a trade secret. If the solid waste management authority determines that such information is a trade secret, it shall not disclose that information unless ordered to do so pursuant to a court order.

3. The owner or operator of a materials recovery facility shall comply with the requirements of [NAC 444A.135](#) concerning the reporting of recycled material.

(Added to NAC by Environmental Comm'n by R173-99, eff. 2-9-2000)

NAC 444.74771 Closure of facility. ([NRS 444.560](#))

1. The owner or operator of a materials recovery facility shall notify the solid waste management authority in writing at least 90 days before the date the facility is expected to close. The facility may not accept any solid waste after the expected closing date.

2. The owner or operator shall, within 30 days after receiving the final shipment of solid waste, remove all remaining solid waste, litter, recovered materials and inoperable equipment in accordance with the plan for closure of the facility required by [NAC 444.74747](#), except that all putrescible waste must be removed within 72 hours after receipt.

(Added to NAC by Environmental Comm'n by R173-99, eff. 2-9-2000)

NAC 444.74775 Surety bond or other financial assurance required to cover cost of closure. ([NRS 444.560](#))

1. The owner or operator of a materials recovery facility shall obtain a surety bond, or any other mechanism of financial assurance approved by the solid waste management authority, to cover the cost to close the facility, including the removal and proper disposal of the maximum inventory of waste and recovered materials for which the facility is designed. The owner or operator shall provide financial assurance for the closure of the facility until the facility is closed and the closure has been approved by the solid waste management authority.

2. The surety bond must be issued by a corporation licensed to do business in this State and include an indemnity agreement that guarantees payment to a trust fund or to the solid waste management authority.

3. If payment is guaranteed to a trust fund, the trustee of the trust fund must be an entity which is authorized to act as a trustee and whose trust operations are regulated and examined by a federal or state agency.

4. The owner or operator of the materials recovery facility or any other person who is authorized to conduct activities for the closure of the facility may request reimbursement from the trustee for any cost incurred to close the facility. The trustee may provide reimbursement for that cost only if there is sufficient money in the trust fund to pay the remaining costs to close the facility, and proof and justification of the cost is placed in the operating records of the facility. The owner or operator shall notify the solid waste management authority that the proof and justification for the reimbursement of the cost was placed in the operating records of the facility and that he or she has received the reimbursement.

5. The owner or operator of the facility shall review annually the estimate of the cost to close the facility upon which the bond or other mechanism of financial assurance is based and submit the estimate to the solid waste management authority for its review and approval.

(Added to NAC by Environmental Comm'n by R173-99, eff. 2-9-2000)

NAC 444.74779 Compliance with plans for design and operation; suspension or revocation of approval to operate. ([NRS 444.560](#))

1. A materials recovery facility must comply with the plans for the design and operation of the facility approved by the solid waste management authority. A materials recovery facility must not:

- (a) Contribute to the pollution of the air or waters of the State;
- (b) Cause an impairment of the environment;
- (c) Cause a health or safety hazard to employees of the facility or the general public; or
- (d) Cause a public nuisance.

2. The solid waste management authority may suspend or revoke its approval to operate a materials recovery facility if the owner or operator of the facility fails to comply with the provisions of [NAC 444.7474](#) to [444.74779](#), inclusive.

(Added to NAC by Environmental Comm'n by R173-99, eff. 2-9-2000)

Appeals and Requests for Variance

NAC 444.748 Petition for variance; appeals. ([NRS 444.560](#))

1. Any person who believes that an alternative to any standard specified in [NAC 444.570](#) to [444.7499](#), inclusive, will comply with the intent of the specified standard and will protect public health and the environment, may petition the State Environmental Commission for a variance in accordance with its procedural rules. A variance may not be granted if it is inconsistent with the federal criteria for landfills set forth in 40 C.F.R. Part 258, as that part existed on November 8, 1993.

2. Any person who wishes to appeal from a decision or action of the solid waste management authority may do so. Such an appeal must be made in writing in accordance with the State Environmental Commission's procedural rules.

[Environmental Comm'n, Solid Waste Mgt Reg. §§ 6.1 & 6.2, eff. 9-21-77]—(NAC A 11-8-93; 3-1-94)

Groundwater Monitoring and Corrective Action

NAC 444.7481 Suspension and continuation of monitoring requirements. ([NRS 444.560](#))

1. The requirements for monitoring groundwater set forth in [NAC 444.7483](#) to [444.7492](#), inclusive, may be suspended by a solid waste management authority for a municipal solid waste landfill unit if the owner or operator can demonstrate that there is no potential for migration of hazardous constituents from that unit to the uppermost aquifer during the active life of the unit, including the period of closure and postclosure. The demonstration must be certified by a qualified groundwater scientist and approved by the solid waste management authority. The demonstration must be based upon:

(a) Measurements collected at specific field sites and the sampling and analysis of physical, chemical and biological processes affecting the fate and transportation of contaminants; and

(b) Predictions of the fate and transportation of contaminants which are based on the maximum possible rate of the migration of the contaminants and a consideration of the impacts on public health and safety and the environment.

2. Once monitoring of groundwater begins at a municipal solid waste landfill unit, the owner or operator of the unit shall continue to monitor the groundwater throughout the active life of the unit, including the period of closure and postclosure, as specified in [NAC 444.6894](#).

(Added to NAC by Environmental Comm'n, eff. 11-8-93; A 3-1-94; 11-9-95; 11-9-95)

NAC 444.7482 Alternative schedule for complying with monitoring requirements. ([NRS 444.560](#))

1. A solid waste management authority may establish an alternative schedule for the owners or operators of existing municipal solid waste landfill units or lateral expansions within the area of its jurisdiction to comply with [NAC 444.7483](#) to [444.7499](#), inclusive. The schedule must ensure that at least 50 percent of all existing municipal solid waste landfill units within the area of its jurisdiction are in compliance by October 9, 1994, and all existing municipal solid waste landfill units within the area of its jurisdiction are in compliance by October 9, 1996. In establishing the schedule for compliance, the solid waste management authority shall consider potential risks posed by the units or lateral expansions to public health and safety and the environment, including the:

(a) Proximity of persons and environmental conditions that may be affected by those risks;

(b) Design of the municipal solid waste landfill unit;

(c) Age of the municipal solid waste landfill unit;

(d) Size of the municipal solid waste landfill unit;

(e) Types and quantities of wastes disposed of at the unit, including sewage sludge; and

(f) Resource value of the underlying aquifer, including:

(1) Its current and future uses;

(2) Its proximity and rate of withdrawal of users; and

(3) The quality and quantity of groundwater.

2. The solid waste management authority may establish alternative schedules for demonstrating compliance with:

(a) The provisions of [NAC 444.7483](#) that require notification of the placement of the certification in the operating plan;

(b) The provisions of [NAC 444.7489](#) relating to:

(1) Notification and the placement of the notice in the operating record of any statistically significant increase in levels of constituents listed in Appendix I; and

(2) The program for assessment monitoring;

(c) The provisions of [NAC 444.749](#) relating to:

(1) The sampling and analyzing of constituents listed in Appendix II;

(2) Placement in the operating record of the notice that constituents listed in Appendix II have been detected and notification of that notice; and

(3) Sampling for constituents listed in Appendix I or II;

(d) The provisions of [NAC 444.7491](#) relating to notification and the placement of the notice in the operating record of any statistically significant increase above the standard for the protection of groundwater;

(e) The provisions of [NAC 444.7491](#) and [444.7493](#) relating to the assessment of corrective measures;

(f) The provisions of [NAC 444.7494](#) relating to the selection of a remedy and notification of the placement of documents relating to the selection in the operating record; and

(g) The provisions of [NAC 444.7498](#) and [444.7499](#) relating to the notification of the placement in the operating record of:

- (1) Alternative measures of corrective action; and
 - (2) Certification of the completion of the remedy.
- (Added to NAC by Environmental Comm'n, eff. 11-8-93)

NAC 444.7483 Requirements concerning system for monitoring groundwater. ([NRS 444.560](#))

1. The owner or operator of a municipal solid waste landfill unit shall install a system for monitoring groundwater which consists of a sufficient number of wells, installed at appropriate locations and depths, to yield samples of groundwater from the uppermost aquifer which:

(a) Represent the quality of background groundwater which has not been affected by leakage from the unit. A determination of background quality may include the sampling of wells that are not hydraulically upgradient of the waste management area if:

- (1) Hydrogeologic conditions do not allow the owner or operator to determine which wells are hydraulically upgradient; or
- (2) Sampling at other wells will provide an indication of the quality of the background groundwater which is as representative or more representative than that provided by the upgradient wells.

(b) Represent the quality of groundwater at the boundary of the waste management unit.

Ê The monitoring system must be installed to ensure detection of contaminants in the groundwater in the uppermost aquifer. When physical obstacles preclude installation of wells to monitor groundwater at the boundary of the waste management unit, a downgradient monitoring system may be installed at the closest practicable distance hydraulically downgradient from the boundary which ensures detection of contamination of groundwater in the uppermost aquifer.

2. If a disposal site has more than one municipal solid waste management landfill unit, the solid waste management authority may approve a system for monitoring groundwater with multiple units instead of separate systems for each municipal solid waste landfill unit, if the system complies with the requirements of subsection 1 and is as protective of public health and safety and the environment as the separate systems. To approve a system with multiple units, the solid waste management authority shall consider the:

- (a) Number, spacing and orientation of the municipal solid waste landfill units;
- (b) Hydrogeologic setting;
- (c) History of the disposal site;
- (d) Engineering design of the municipal solid waste landfill units; and
- (e) Type of waste accepted at the municipal solid waste landfill units.

3. Monitoring wells must be cased in a manner which maintains the integrity of the bore hole of the monitoring well. The casing must be screened or perforated and packed with gravel or sand, if necessary, to enable the collection of samples of groundwater. The annular space above the sampling depth must be sealed to prevent contamination of samples and the groundwater.

4. The owner or operator shall notify the solid waste management authority that documentation concerning the design, installation, development and decommission of any monitoring wells, piezometers and other measurement, sampling and analytical devices has been placed in the records of the site. The monitoring wells, piezometers and other measurement, sampling and analytical devices must be operated and maintained so that they perform to design specifications throughout the life of the monitoring program.

5. The number, spacing and depths of the monitoring systems must be:

(a) Determined based upon technical information for each specific site, including a thorough characterization of the:

(1) Thickness of the aquifer and the rate and direction of the flow of groundwater, including seasonal and temporal fluctuations; and

(2) Saturated and unsaturated geologic units and fill materials overlying the uppermost aquifer, materials comprising the uppermost aquifer and materials comprising the confining unit defining the lower boundary of the uppermost aquifer, including, without limitation, the thicknesses, stratigraphy, lithology, hydraulic conductivities, porosities and effective porosities of these materials; and

(b) Certified by a qualified groundwater scientist and approved by the solid waste management authority. Within 14 days after receiving certification and approval, the owner or operator shall place the certification in

the records for the site.

6. As used in this section:

(a) "Annular space" means the space between the bore hole and well casing.

(b) "Boundary of the waste management unit" means a vertical surface located at the hydraulically downgradient limit of the unit that extends down in the uppermost aquifer.

(Added to NAC by Environmental Comm'n, eff. 11-8-93)

NAC 444.7484 Program for sampling and analysis. (NRS 444.560)

1. The owner or operator shall notify the solid waste management authority that the documentation of the program for sampling and analysis has been placed in the records of the disposal site.

2. A system for monitoring groundwater must include:

(a) Consistent sampling and analytical procedures designed to ensure monitoring results which provide an accurate representation of the quality of the background and downgradient groundwater at the monitoring wells installed in compliance with [NAC 444.7483](#).

(b) Procedures and techniques for:

(1) The collection, preservation and shipment of samples;

(2) Analyzing samples;

(3) The control of the chain of custody; and

(4) Quality assurance and quality control.

(c) Methods for sampling and analysis which are appropriate for sampling groundwater and which accurately measure hazardous constituents and other monitoring parameters in samples of groundwater. Samples of groundwater must not be filtered in the field before they are analyzed in the laboratory.

3. The sampling procedures and frequency must be protective of public health and safety and the environment.

4. Each time groundwater is sampled, the elevations of groundwater must be measured in each well immediately before purging and the owner or operator shall determine the rate and direction of the flow of groundwater. The elevations of groundwater in wells which monitor the same disposal site must be measured within a period that is short enough to avoid temporal variations in the flow of groundwater which could preclude an accurate determination of the rate of flow and direction of groundwater.

5. The owner or operator shall determine the quality of the background groundwater in a hydraulically upgradient or background well for each of the monitoring parameters or constituents required by the system for monitoring groundwater which applies to the municipal solid waste landfill unit, as determined pursuant to [NAC 444.7487](#) or [444.749](#). The quality of the background groundwater may be determined at wells that are not located hydraulically upgradient from the municipal solid waste landfill unit if the monitoring system meets the requirements of [NAC 444.7483](#).

6. The number of samples collected to establish data concerning the quality of groundwater must be consistent with the appropriate statistical procedures set forth in [NAC 444.7485](#). The sampling procedures used must be those specified by [NAC 444.7488](#) for detection monitoring, [NAC 444.749](#) for assessment monitoring and [NAC 444.7493](#) for corrective action.

(Added to NAC by Environmental Comm'n, eff. 11-8-93)

NAC 444.7485 Statistical methods for evaluating data; performance standards. (NRS 444.560)

1. An owner or operator shall specify in the records for the disposal site one of the following statistical methods to be used in evaluating data from monitoring groundwater for each hazardous constituent:

(a) A parametric analysis of variance followed by procedures for multiple comparisons to identify statistically significant evidence of contamination. This method must include an estimation and testing of the contrasts between the mean for each compliance well and the background mean levels for each constituent.

(b) An analysis of variance based on ranks followed by procedures for multiple comparisons to identify statistically significant evidence of contamination. This method must include an estimation and testing of the contrasts between the median for each compliance well and the background median levels for each constituent.

(c) A procedure using tolerance or predictional intervals whereby an interval for each constituent is established from the distribution of the background data and the level of each constituent in each compliance

well is compared to the upper tolerance or prediction limit.

(d) A procedure using a control chart which gives limits of control for each constituent.

(e) Any other statistical method which meets the performance standards set forth in subsection 3. The owner or operator shall place a written justification for using the statistical method in the operating records for the disposal site and notify the solid waste management authority of the use of this alternative method. The justification must demonstrate that the alternative method meets the performance standards set forth in subsection 3.

2. The statistical method chosen pursuant to this section must be conducted separately for each hazardous constituent in each well.

3. Any statistical method chosen pursuant to this section must comply with the following performance standards, as appropriate:

(a) The statistical method used to evaluate data from monitoring groundwater must be appropriate for the distribution of chemical parameters or hazardous constituents. If the distribution of the chemical parameters or hazardous constituents is shown by the owner or operator to be inappropriate for a normal theory test, then the data must be transformed or a theory test that does not use data from the distribution of chemical parameters or hazardous constituents must be used. If the distributions for the constituents differ, more than one statistical method may be used, if needed.

(b) If a procedure which compares individual wells is used to compare the concentration of constituents for an individual compliance well with background concentrations of constituents or a standard for the protection of groundwater, the test must be done at a Type I error level that is no less than 0.01 for each testing period. If a procedure using multiple comparisons is used, the Type I error level for each testing period must be no less than 0.05, and the Type I error level of no less than 0.01 for comparisons of individual wells must be maintained. This performance standard does not apply to tolerance intervals, prediction intervals or control charts.

(c) If a control chart is used to evaluate data, the control chart and its associated values for its parameters must be protective of public health and safety and the environment. The parameters must be determined after considering the number of samples in the background database, the distribution of data and the range of the concentration values for each constituent.

(d) If a tolerance interval or a prediction interval is used to evaluate data from monitoring groundwater, the levels of confidence and, for tolerance intervals, the percentage of the population of samples which the interval must contain, must be protective of public health and safety and the environment. These parameters must be determined after considering the number of samples in the background database, the data distribution and the range of the concentration values for each constituent of concern.

(e) The statistical method must account for data below the limit of detection with one or more statistical procedures which are protective of public health and safety and the environment. Any practical quantitation limit which is used in the statistical method must be the lowest concentration level which can be reliably achieved within specified limits of precision and accuracy during routine conditions for the operation of a laboratory which are available to the disposal site.

(f) If necessary, the statistical method must include procedures to control or correct for seasonal and spatial variability and temporal correlation in the data.

4. As used in this section, "Type I error" means an error which occurs when a true null hypothesis is rejected erroneously and, as a result, a test for the monitoring of groundwater incorrectly indicates contamination or an increase in contamination at a regulated unit.

(Added to NAC by Environmental Comm'n, eff. 11-8-93)

NAC 444.7486 Determination of statistically significant increase over background values. ([NRS 444.560](#))

1. Within 14 days after completing sampling and analysis, the owner or operator shall determine whether there is a statistically significant increase over background values for each parameter or constituent at each monitoring well required in the system for monitoring groundwater which applies to the municipal solid waste landfill unit, as determined pursuant to [NAC 444.7487](#) or [444.749](#).

2. In determining whether a statistically significant increase has occurred, the owner or operator shall compare the quality of the groundwater of each parameter or constituent at each monitoring well designated

pursuant to [NAC 444.7483](#) to the background value of that constituent, according to the statistical procedures and performance standards set forth in [NAC 444.7485](#).

(Added to NAC by Environmental Comm'n, eff. 11-8-93)

NAC 444.7487 Constituents required to be monitored; establishment of list of alternative parameters for inorganic materials. ([NRS 444.560](#))

1. An owner or operator shall monitor constituents at all wells monitoring groundwater pursuant to [NAC 444.7483](#). At a minimum, the constituents listed in Appendix I must be monitored.

2. The solid waste management authority may delete any of the parameters for monitoring constituents listed in Appendix I for a municipal solid waste landfill unit if it is shown that the deleted constituents are not reasonably expected to be contained in or derived from the waste contained in the unit.

3. The solid waste management authority may establish a list of alternative parameters for inorganic materials for a municipal solid waste landfill unit, in lieu of any of the following:

- (a) Antimony;
- (b) Arsenic;
- (c) Barium;
- (d) Beryllium;
- (e) Cadmium;
- (f) Chromium;
- (g) Cobalt;
- (h) Copper;
- (i) Lead;
- (j) Nickel;
- (k) Selenium;
- (l) Silver;
- (m) Thallium;
- (n) Vanadium; and
- (o) Zinc,

Ê if the alternative parameters provide a reliable indication of releases of inorganic materials from the municipal solid waste landfill unit into the groundwater.

4. In establishing alternative parameters, the solid waste management authority shall consider:

(a) The types, quantities and concentrations of constituents in waste managed at the municipal solid waste landfill unit;

(b) The mobility, stability and persistence of constituents or their reaction products in the unsaturated zone beneath the municipal solid waste landfill unit;

(c) The detectability of indicator parameters, constituents and reaction products in the groundwater; and

(d) The concentration or values and coefficients of variation of monitoring parameters or constituents in the groundwater background.

(Added to NAC by Environmental Comm'n, eff. 11-8-93)

NAC 444.7488 Program for detection monitoring. ([NRS 444.560](#))

1. Except as otherwise provided in subsection 2, all constituents listed in Appendix I or in the list of alternative parameters established pursuant to [NAC 444.7487](#) must be monitored at least semiannually during the active life of a municipal solid waste landfill unit, including the period of closure and postclosure. At least four independent samples from each background and downgradient well must be collected and analyzed for the constituents during the first semiannual sampling. At least one sample from each background and downgradient well must be collected and analyzed during subsequent semiannual sampling.

2. The solid waste management authority may specify an appropriate alternative schedule for monitoring constituents listed in Appendix I or the list of alternative parameters. The alternative schedule may require monitoring not less than annually. The alternative schedule must be based on the:

- (a) Lithology of the aquifer and unsaturated zone;
- (b) Hydraulic conductivity of the aquifer and unsaturated zone;

- (c) Rate of flow of groundwater;
 - (d) Minimum distance between the upgradient edge of the municipal solid waste landfill unit and downgradient monitoring well screen; and
 - (e) Resource value of the aquifer.
- (Added to NAC by Environmental Comm'n, eff. 11-8-93)

NAC 444.7489 Procedures upon determination of statistically significant increase of Appendix I constituents or alternative parameters. (NRS 444.560)

1. If an owner or operator determines, pursuant to [NAC 444.7485](#), that there is a statistically significant increase over background for one or more of the constituents listed in Appendix I or the list of alternative parameters established pursuant to [NAC 444.7487](#), at any monitoring well at the boundary specified by [NAC 444.7483](#), the owner or operator shall:

(a) Within 14 days after making this determination, place a notice in the records of the disposal site indicating which constituents have shown statistically significant increases and notify the solid waste management authority that this notice was placed in the operating records; and

(b) Except as otherwise provided in subsection 2, establish a program for assessment monitoring pursuant to [NAC 444.749](#) and [444.7491](#) within 90 days after making the determination.

2. The owner or operator may demonstrate that a source other than a municipal solid waste landfill unit caused the contamination or that the statistically significant increase resulted from an error in sampling, analysis or statistical evaluation or from a natural variation in the quality of groundwater. A report documenting this demonstration must be certified by a qualified groundwater scientist, approved by the solid waste management authority and placed in the operating records of the disposal site. If a successful demonstration is made and approved, the owner or operator may continue monitoring constituents as specified in this section and [NAC 444.7487](#) and [444.7488](#). If, after 90 days, a successful demonstration is not made, the owner or operator shall initiate a program for assessment monitoring pursuant to [NAC 444.749](#) and [444.7491](#).

(Added to NAC by Environmental Comm'n, eff. 11-8-93)

NAC 444.749 Program for assessment monitoring. (NRS 444.560)

1. If a statistically significant increase over background has been detected for one or more of the constituents listed in Appendix I or the list of alternative parameters established pursuant to [NAC 444.7487](#), an owner or operator shall establish a program for assessment monitoring.

2. Except as otherwise provided in subsection 3, within 90 days after initiating a program for assessment monitoring, and annually thereafter, the owner or operator shall sample and analyze the groundwater for all constituents identified in Appendix II. At least one sample from each downgradient well must be collected and analyzed during each sampling. For any constituent detected in the downgradient wells as a result of this analysis, at least four independent samples from each background and downgradient well must be collected and analyzed to establish background for the constituents. The solid waste management authority may specify an appropriate subset of wells to be sampled and analyzed for constituents listed in Appendix II during assessment monitoring. The solid waste management authority may delete any of the parameters for monitoring constituents listed in Appendix II for a municipal solid waste landfill unit if it is shown that the deleted constituents are not reasonably expected to be in or derived from the waste contained in the unit.

3. The solid waste management authority may specify an appropriate alternative schedule for monitoring all constituents listed in Appendix II. The alternative schedule must be based on the:

- (a) Lithology of the aquifer and unsaturated zone;
- (b) Hydraulic conductivity of the aquifer and unsaturated zone;
- (c) Rate of flow of groundwater;
- (d) Minimum distance between the upgradient edge of the municipal solid waste landfill unit and downgradient monitoring well screen;
- (e) Resource value of the aquifer; and
- (f) Nature, fate and transportation of any constituents detected in accordance with this section.

4. After obtaining the results from the initial or subsequent samplings pursuant to subsection 2 or 3, the owner or operator shall:

(a) Within 14 days, place a notice in the operating records of the disposal site identifying the constituents listed in Appendix II which have been detected and submit the sampling results to the solid waste management authority.

(b) Within 90 days, and on at least a semiannual basis thereafter:

(1) Resample all wells specified by [NAC 444.7483](#);

(2) Conduct analyses for all constituents listed in Appendix I or the list of alternative parameters established pursuant to [NAC 444.7487](#), and for those constituents in Appendix II which are detected as a result of sampling pursuant to subsection 2 or 3; and

(3) Record their concentrations in the operating records for the disposal site.

Ê At least one sample from each background and downgradient well must be collected and analyzed during the samplings. The solid waste management authority may specify an alternative schedule for monitoring the constituents referred to in this section. The alternative schedule for constituents listed in Appendix I or the list of alternative parameters established pursuant to [NAC 444.7487](#) may not require monitoring not less than annually. The alternative schedule must be based on the factors specified in subsection 3.

(c) Establish background concentrations for any constituents detected pursuant to paragraph (b) or subsection 2 or 3.

(Added to NAC by Environmental Comm'n, eff. 11-8-93)

NAC 444.7491 Procedures upon determination of concentrations of Appendix II constituents.
([NRS 444.560](#))

1. If the concentrations of all constituents listed in Appendix II are shown to be at or below background values, using the statistical procedures set forth in [NAC 444.7485](#), for two consecutive samplings, the owner or operator shall notify the solid waste management authority of this finding and may return to the monitoring procedures set forth in [NAC 444.7488](#).

2. If the concentrations of any constituents listed in Appendix II are above background values, but all concentrations are below the standard for the protection of groundwater established pursuant to [NAC 444.7492](#), using the statistical procedures in [NAC 444.7485](#), the owner or operator shall continue monitoring in accordance with this section.

3. Except as otherwise provided in subsection 4, if one or more constituents listed in Appendix II are detected at statistically significant levels above the standard for the protection of groundwater in any sampling, the owner or operator shall:

(a) Within 14 days of this finding, place a notice in the operating records for the disposal site identifying the constituents which have exceeded the standard and notify the solid waste management authority and all appropriate local government officials that the notice has been placed in the operating records;

(b) Characterize the nature and extent of the release by installing additional monitoring wells as necessary;

(c) Install at least one additional monitoring well at the boundary of the municipal solid waste landfill unit in the direction of the migration of the contaminant and sample this well in accordance with [NAC 444.749](#);

(d) Notify all persons who own or reside on the land which directly overlies any part of the plume of contamination if contaminants have migrated off the site as indicated by the sampling of wells in accordance with this section; and

(e) Initiate an assessment of corrective measures pursuant to [NAC 444.7493](#).

4. In lieu of complying with the provisions of subsection 3, the owner or operator may demonstrate that a source other than a municipal solid waste landfill unit caused the contamination or that the statistically significant increase resulted from error in sampling, analysis or statistical evaluation or from a natural variation in the quality of the groundwater. A report documenting this demonstration must be certified by a qualified groundwater scientist, approved by the solid waste management authority and placed in the operating records of the unit. If a successful demonstration is made, the owner or operator shall continue monitoring in accordance with the program for assessment pursuant to this section, and may return to detection monitoring if the constituents are at or below background in accordance with subsection 1. Until a successful demonstration is made, the owner or operator shall comply with the provisions of subsection 3.

(Added to NAC by Environmental Comm'n, eff. 11-8-93)

NAC 444.7492 Establishment of standard for protection of groundwater. ([NRS 444.560](#))

1. The Administrator shall establish a standard for the protection of groundwater for each constituent listed in Appendix II detected in the groundwater as follows:

(a) For a constituent for which a maximum contaminant level has been set forth pursuant to the Safe Drinking Water Act, 42 U.S.C. §§ 300f et seq., and 40 C.F.R. Part 141, as those sections existed on November 8, 1993, the maximum contaminant level for that constituent.

(b) For a constituent for which a maximum contaminant level has not been adopted, a level equal to:

(1) The background concentration of the constituent; or

(2) An appropriate level that is based on the protection of public health and safety and complies with the following requirements:

(I) The level must be established in compliance with state and federal guidelines for assessing the health risks of environmental pollutants;

(II) The level must be based on scientific studies conducted in accordance with the Toxic Substances Control Act Good Laboratory Practice Standards, 40 C.F.R. Part 792, as those standards exist on March 1, 1994, or equivalent studies;

(III) For carcinogens, the level must represent a concentration of the constituent that is associated with an excess risk of cancer caused by a continuous lifetime exposure which is within a range of 1×10^{-4} to 1×10^{-6} , inclusive; and

(IV) For systemic toxicants, the level must represent a concentration to which a human being could be exposed on a daily basis without an appreciable risk of deleterious effects during the course of his or her lifetime. As used in this sub-subparagraph, "systemic toxicant" includes toxic chemicals that cause deleterious effects other than cancer or a mutation.

(c) For a constituent for which the background level is higher than the maximum contaminant level set forth in paragraph (a), the background concentration of the constituent.

2. In establishing standards pursuant to paragraph (b) of subsection 1, the Administrator may consider:

(a) Multiple contaminants in the groundwater;

(b) Potential threats to sensitive areas of the environment; and

(c) Other threats specific to that site or potential threats to groundwater.

(Added to NAC by Environmental Comm'n, eff. 11-8-93; A 3-1-94)

NAC 444.7493 Assessment of corrective measures upon determination that level of any Appendix II constituent exceeds standard for protection of groundwater; public notice and comment. ([NRS 444.560](#))

1. Within 90 days after finding that any of the constituents listed in Appendix II have been detected at a statistically significant level exceeding the standards for the protection of groundwater established pursuant to [NAC 444.7492](#), the owner or operator shall initiate an assessment of corrective measures. Such an assessment must be completed within a reasonable period specified by the solid waste management authority and submitted for review and approval by the solid waste management authority.

2. The owner or operator shall continue monitoring in accordance with [NAC 444.749](#) and [444.7491](#) until the solid waste management authority approves the assessment of corrective measures.

3. The assessment must include an analysis of the effectiveness of potential corrective measures in meeting all of the requirements and objectives of the remedy in accordance with [NAC 444.7494](#), [444.7495](#) and [444.7496](#), including, but not limited to:

(a) The performance, reliability, ease of implementation and potential impacts of appropriate potential remedies, including safety impacts, cross-media impacts and the control of exposure to any residual contamination;

(b) The time required to begin and complete the remedy;

(c) The costs of carrying out the remedy; and

(d) Any state or local statutory or regulatory requirements or other environmental or public health and safety requirements which may substantially affect the implementation of the remedy.

4. The solid waste management authority shall issue a public notice and accept public comment for 30 days before the selection of a remedy. If requested during the period of public comment, a public hearing

must be held to discuss the assessment of corrective measures.

(Added to NAC by Environmental Comm'n, eff. 11-8-93)

NAC 444.7494 Selection and approval of remedy by solid waste management authority. (NRS 444.560)

1. Based on the results of the assessment of corrective measures conducted pursuant to [NAC 444.7493](#) and the public comments received, if any, the solid waste management authority may approve a remedy which:

- (a) Is protective of public health and safety and the environment;
- (b) Complies with the standard for the protection of groundwater established pursuant to [NAC 444.7492](#);
- (c) Controls the sources of releases so as to reduce or eliminate, to the maximum extent practicable, further releases of constituents listed in Appendix II which may pose a threat to the public health and safety or the environment; and
- (d) Complies with standards for the management of wastes as specified in subsection 3 of [NAC 444.7498](#).

2. In selecting a remedy, the solid waste management authority shall consider:

(a) The long-term and short-term effectiveness and protectiveness of a potential remedy, and the degree of certainty that the remedy will prove successful, based on the:

- (1) Magnitude of reducing existing risks;
- (2) Magnitude of residual risks and the likelihood of further releases caused by waste remaining after the implementation of a potential remedy;
- (3) Type and degree of long-term management required, including monitoring, operation and maintenance;

(4) Short-term risks which might be posed to the community, workers or the environment during implementation of a potential remedy, including potential threats to public health and safety and the environment associated with the excavation, transportation, and redisposal or containment of the constituent;

(5) Time until full protection is achieved;

(6) Potential for exposure of persons and environmental conditions to remaining wastes, considering the potential threat to public health and safety and the environment associated with the excavation, transportation, redisposal or containment;

(7) Long-term reliability of the engineering and institutional controls; and

(8) Potential need for the replacement of the remedy.

(b) The effectiveness of the remedy in controlling the source to reduce further releases based on the extent to which:

(1) Practices for containment will reduce further releases; and

(2) Technologies for treatment may be used.

(c) The ease or difficulty of carrying out a potential remedy based on the consideration of the following factors:

(1) The degree of difficulty associated with constructing the technology;

(2) The expected operational reliability of the technologies;

(3) The need to coordinate with and obtain necessary approvals and permits from other agencies;

(4) The availability of necessary equipment and specialists; and

(5) The available capacity and location of needed treatment, storage and disposal services.

(d) The practicable capability of the owner or operator to carry out the remedy, including a consideration of his or her technical and economic capability.

(e) The degree to which concerns of the community are addressed by the potential remedy.

(Added to NAC by Environmental Comm'n, eff. 11-8-93)

NAC 444.7495 Schedule for initiation and completion of remedial activities. (NRS 444.560) An owner or operator shall submit to the solid waste management authority a schedule for initiating and completing remedial activities. The schedule must require the initiation of remedial activities within a reasonable period and must be approved by the solid waste management authority. In proposing the schedule, the owner or operator shall consider:

1. The extent and nature of contamination;

2. The practical capabilities of remedial technologies in achieving compliance with standards for the protection of groundwater established pursuant to [NAC 444.7492](#) and other objectives of the remedy;
 3. The availability of systems for the treatment or disposal of wastes managed during the implementation of the remedy;
 4. The desirability of utilizing technologies which are experimental or not widely available, but which may offer significant advantages over readily available technologies in terms of effectiveness, reliability, safety or ability to achieve remedial objectives;
 5. The potential risks to public health and safety and the environment from exposure to contamination before the completion of the remedy;
 6. The resource value of the aquifer, including:
 - (a) The current and future uses;
 - (b) The proximity and rate of withdrawal of users;
 - (c) The quantity and quality of groundwater;
 - (d) The potential damage to wildlife, crops, vegetation and physical structures caused by exposure to a constituent;
 - (e) The hydrogeologic characteristics of the disposal site and surrounding land;
 - (f) The cost of removing and treating groundwater; and
 - (g) The cost and availability of alternative water supplies;
 7. The practicable capability of the owner or operator to carry out the remedial activities; and
 8. Any other relevant factors.
- (Added to NAC by Environmental Comm'n, eff. 11-8-93)

NAC 444.7496 Exemptions from requirement of remediation. ([NRS 444.560](#))

1. The solid waste management authority and the Administrator may jointly determine that remediation of a release of a constituent listed in Appendix II from a municipal solid waste landfill unit is not necessary if the owner or operator demonstrates to the solid waste management authority and the Administrator that:
 - (a) The groundwater is additionally contaminated by substances that have originated from a source other than a municipal solid waste landfill unit and those substances are present in such concentrations that the clean up of the release from the municipal solid waste landfill unit would provide no significant reduction in risk to persons or environmental conditions that are or may be affected by the release;
 - (b) The constituents are present in groundwater which:
 - (1) Is not currently or reasonably expected to be a source of drinking water; and
 - (2) Is not hydraulically connected with waters to which the constituents are migrating or are likely to migrate in concentrations which would exceed the standards for the protection of groundwater established pursuant to [NAC 444.7492](#);
 - (c) Remediation of the releases is technically impracticable; or
 - (d) Remediation would result in unacceptable cross-media impacts.
2. The provisions of subsection 1 do not affect the authority of the Administrator or solid waste management authority to require the owner or operator to undertake measures to control the source of the constituent or any other measures which may be necessary to:
 - (a) Eliminate or minimize further releases to the groundwater;
 - (b) Prevent exposure of the groundwater to constituents; or
 - (c) Remediate the groundwater to concentrations which are technically practicable and significantly reduce threats to public health and safety and the environment.

(Added to NAC by Environmental Comm'n, eff. 11-8-93)

NAC 444.7497 Program for monitoring corrective action; performance of remedial activities; interim measures to protect public. ([NRS 444.560](#)) Based on the schedule established pursuant to [NAC 444.7495](#) for the initiation and completion of remedial activities, the owner or operator shall:

1. Establish and carry out a program for monitoring the corrective action for the groundwater which:
 - (a) At a minimum, meets the requirements for monitoring set forth in [NAC 444.749](#) and [444.7491](#);
 - (b) Indicates the effectiveness of the remedy; and
 - (c) Demonstrates compliance with the standard for the protection of groundwater in accordance with

paragraph (b) of subsection 1 of [NAC 444.7499](#);

2. Carry out the remedy selected pursuant to [NAC 444.7494](#), [444.7495](#) and [444.7496](#); and

3. Take any interim measures necessary to ensure the protection of public health and safety and the environment. Interim measures must, to the greatest extent practicable, be consistent with the objectives, and contribute to the performance, of any remedy which may be required pursuant to [NAC 444.7494](#), [444.7495](#) and [444.7496](#). In determining whether interim measures are necessary, the owner or operator shall consider:

(a) The time required to develop and carry out a final remedy;

(b) The actual or potential exposure of nearby populations or environmental conditions to hazardous constituents;

(c) The actual or potential contamination of supplies for drinking water or sensitive ecosystems;

(d) The further degradation of the groundwater which may occur if remedial action is not initiated expeditiously;

(e) Weather conditions which may cause hazardous constituents to migrate or be released;

(f) The risk of fire or explosion, or the potential for exposure to hazardous constituents as a result of an accident or failure of a container or handling system; and

(g) Any other situations which may pose threats to public health and safety and the environment.

(Added to NAC by Environmental Comm'n, eff. 11-8-93)

NAC 444.7498 Ineffectiveness of selected remedy; impracticability of currently available methods of remediation. (NRS 444.560)

1. The solid waste management authority may determine, based on information developed after the initiation of a remedy or any other information, that compliance with the requirements of [NAC 444.7494](#) is not being achieved by the remedy selected. If the solid waste management authority makes such a determination, the owner or operator shall carry out any other method or technique which could practicably comply with the requirements, unless the solid waste management authority determines pursuant to subsection 2 that compliance cannot be practicably achieved.

2. If the solid waste management authority and the Administrator determine that compliance with the requirements of [NAC 444.7494](#) cannot be practically achieved with any currently available methods, the owner or operator shall:

(a) Obtain certification from a qualified groundwater scientist and the approval of the solid waste management authority and Administrator that compliance with [NAC 444.7494](#) cannot be practically achieved with any currently available methods;

(b) Carry out alternative measures to control exposure of persons or the environment to residual contamination, as necessary to protect public health and safety and the environment;

(c) Carry out alternate measures for the control of the sources of contamination, or for the removal or decontamination of equipment, units, devices or structures which are:

(1) Technically practicable; and

(2) Consistent with the overall objective of the remedy; and

(d) Obtain the approval of the solid waste management authority and the Administrator for the alternative measures before carrying out those measures.

3. All solid wastes managed pursuant to a remedy required by [NAC 444.7494](#), [444.7495](#) and [444.7496](#) or an interim measure required by [NAC 444.7497](#) must be managed in a manner which:

(a) Is protective of public health and safety and the environment; and

(b) Complies with all applicable requirements set forth in the Resource Conservation and Recovery Act of 1976, 42 U.S.C. §§ 6901 et seq., as that act existed on November 8, 1993.

(Added to NAC by Environmental Comm'n, eff. 11-8-93)

NAC 444.7499 Remedy deemed complete; certification of completion. (NRS 444.560)

1. A remedy selected pursuant to [NAC 444.7494](#), [444.7495](#) and [444.7496](#) shall be deemed to be complete when each of the following occurs:

(a) The owner or operator complies with the standards for the protection of groundwater established pursuant to [NAC 444.7492](#) at all points within the plume of contamination which lie beyond the system of wells for monitoring the groundwater established pursuant to [NAC 444.7483](#).

(b) The owner or operator demonstrates that concentrations of constituents listed in Appendix II have not exceeded the standards for the protection of groundwater for a period of 3 consecutive years using the statistical procedures and performance standards set forth in [NAC 444.7485](#). The solid waste management authority and Administrator may specify an alternative length of time during which the owner or operator may demonstrate that concentrations of constituents listed in Appendix II have not exceeded the standards for the protection of groundwater, taking into consideration the:

- (1) Extent and concentration of the release;
- (2) Behavioral characteristics of the constituents in the groundwater;
- (3) Accuracy of monitoring or modeling techniques, including any seasonal, meteorological or other environmental variables which may affect the accuracy of those techniques; and
- (4) Characteristics of the groundwater.

(c) All actions required to complete the remedy have been taken.

2. Within 14 days after the completion of the remedy, the owner or operator shall notify the solid waste management authority that a certification that the remedy has been completed in compliance with the requirements of subsection 1 has been placed in the operating records of the disposal site. The certification must be signed by the owner or operator and a qualified groundwater scientist and approved by the solid waste management authority.

3. When, upon completion of the certification, the solid waste management authority determines that the remedy for corrective action has been completed in accordance with the requirements of subsection 1, the owner or operator is no longer required to comply with the requirements for financial assurance for corrective action pursuant to [NAC 444.6852](#).

(Added to NAC by Environmental Comm'n, eff. 11-8-93)

SEWAGE DISPOSAL

General Provisions

NAC 444.750 Definitions. ([NRS 439.200](#), [444.650](#)) As used in [NAC 444.750](#) to [444.8396](#), inclusive, unless the context otherwise requires, the words and terms defined in [NAC 444.7502](#) to [444.7772](#), inclusive, have the meanings ascribed to them in those sections.

(Supplied in codification; A by Bd. of Health by R129-98, eff. 3-25-99; R100-07, 10-31-2007)

NAC 444.7502 "Absorption trench" defined. ([NRS 439.200](#), [444.650](#)) "Absorption trench" means a trench that is excavated into and uses the native soil for the subsequent absorption and treatment of effluent from a primary treatment unit.

(Added to NAC by Bd. of Health by R129-98, eff. 3-25-99)

NAC 444.7503 "Accessory structure" defined. ([NRS 439.200](#), [444.650](#)) "Accessory structure" means a building or structure, including, without limitation, a workshop, a home office, guest quarters, a pool house and a garage, that:

1. Is separate from a single-family dwelling; and
2. Does not include both a bathroom unit and a kitchen unit.

(Added to NAC by Bd. of Health by R100-07, eff. 10-31-2007)

NAC 444.7504 "Administrative authority" defined. ([NRS 439.200](#), [444.650](#)) "Administrative authority" means the official who, or the board, department or agency which, is established and authorized by this State, or by a county, city or other political subdivision of this State, to administer and enforce regulations governing individual sewage disposal systems.

(Added to NAC by Bd. of Health by R129-98, eff. 3-25-99)

NAC 444.7506 "Aerobic wastewater treatment unit" defined. ([NRS 439.200](#), [444.650](#)) "Aerobic wastewater treatment unit" means a chamber that receives sewage and, through oxidation, decomposes the sewage by the introduction of air into the wastewater to reduce both the level of total suspended solids and

the level of biological oxygen demand to 30 milligrams or less per liter.

(Added to NAC by Bd. of Health by R129-98, eff. 3-25-99)

NAC 444.7508 “Aggregate” defined. ([NRS 439.200](#), [444.650](#)) “Aggregate” means gravel, rock, drain rock or any similar medium used for absorption.

(Added to NAC by Bd. of Health by R129-98, eff. 3-25-99)

NAC 444.751 “Alternative absorption system” defined. ([NRS 439.200](#), [444.650](#)) “Alternative absorption system” means a system, other than an absorption trench, that uses the native soil for the subsequent absorption and treatment of effluent from a primary treatment unit. The term includes, without limitation, a capping fill trench, stepped network of trenches utilizing relief lines, leaching bed, sand filter and elevated mound system.

(Added to NAC by Bd. of Health by R129-98, eff. 3-25-99)

NAC 444.7512 “Alternative treatment system” defined. ([NRS 439.200](#), [444.650](#)) “Alternative treatment system” means a system, or a receptacle other than a septic tank, that is designed and constructed to:

1. Receive the discharge of sewage from a building sewer;
2. Partially or completely treat such sewage; and
3. Discharge effluent for final disposal.

(Added to NAC by Bd. of Health by R129-98, eff. 3-25-99)

NAC 444.7514 “Approved method of sewage disposal” defined. ([NRS 439.200](#), [444.650](#)) “Approved method of sewage disposal” means a method of sewage treatment and disposal that has been approved by the administrative authority.

(Added to NAC by Bd. of Health by R129-98, eff. 3-25-99)

NAC 444.7516 “Approved service provider” defined. ([NRS 439.200](#), [444.650](#)) “Approved service provider” means a person approved by the administrative authority to provide maintenance on an alternative treatment system.

(Added to NAC by Bd. of Health by R100-07, eff. 10-31-2007)

NAC 444.7522 “Backflow” defined. ([NRS 439.200](#), [444.650](#)) “Backflow” means the flow of liquid mixtures or substances into the distributing pipe of potable water from any source other than the intended source of the potable water.

(Added to NAC by Bd. of Health by R129-98, eff. 3-25-99)

NAC 444.7524 “Basal area” defined. ([NRS 439.200](#), [444.650](#)) “Basal area” means the area of natural ground that is covered by the fill material of a mound system.

(Added to NAC by Bd. of Health by R129-98, eff. 3-25-99)

NAC 444.7525 “Bathroom unit” defined. ([NRS 439.200](#), [444.650](#)) “Bathroom unit” means an area of a single-family dwelling or accessory structure which includes a toilet, a sink, and a bathtub or shower.

(Added to NAC by Bd. of Health by R100-07, eff. 10-31-2007)

NAC 444.7528 “Building drain” defined. ([NRS 439.200](#), [444.650](#)) “Building drain” means the piping that conveys sewage within a building or structure.

(Added to NAC by Bd. of Health by R129-98, eff. 3-25-99)

NAC 444.753 “Building sewer” defined. ([NRS 439.200](#), [444.650](#)) “Building sewer” means the piping that extends from the end of the building drain and conveys sewage to a public sewer, private sewer, individual sewage disposal system or other point of disposal.

(Added to NAC by Bd. of Health by R129-98, eff. 3-25-99)

NAC 444.7536 “Capping fill trench” defined. ([NRS 439.200](#), [444.650](#)) “Capping fill trench” means a standard drain field trench, where the invert of the disposal drain pipe is at or slightly below the natural grade of the existing soil, which is covered by a soil cap composed of selected fill material and used to reduce the total trench depth.

(Added to NAC by Bd. of Health by R129-98, eff. 3-25-99)

NAC 444.754 “Cesspool” defined. ([NRS 439.200](#), [444.650](#)) “Cesspool” means a covered excavation in the ground which receives the discharge of domestic sewage or other organic wastes from a drainage system which is designed to retain the organic matter and solids while permitting the liquids to seep through the bottom and sides.

[Bd. of Health, Individ. Sewage Disposal Systems Reg. § 1.2, eff. 11-23-72]—(NAC A by R129-98, 3-25-99)

NAC 444.755 “Commercial system” defined. ([NRS 439.200](#), [444.650](#)) “Commercial system” means an individual sewage disposal system that serves one or more buildings which are not used as single-family dwellings. The term includes, without limitation, an individual sewage disposal system serving offices, watchmen’s quarters, bunkhouses, labor camps, parking facilities for recreational vehicles, factories, multiple-dwelling structures, hotels and shopping centers.

(Added to NAC by Bd. of Health by R129-98, eff. 3-25-99)

NAC 444.758 “Distribution box” defined. ([NRS 439.200](#), [444.650](#)) “Distribution box” means a watertight structure which receives sewage from a septic tank and distributes such sewage in equal portions to two or more pipelines leading to the disposal area.

[Bd. of Health, Individ. Sewage Disposal Systems Reg. § 1.3, eff. 11-23-72]

NAC 444.759 “Domestic sewage” defined. ([NRS 439.200](#), [444.650](#)) “Domestic sewage” means liquid and water-borne waste that is derived from the ordinary living process and is of such character as to permit its satisfactory disposal into a public sewer without special treatment or into a private sewage disposal system. The term does not include industrial waste.

(Added to NAC by Bd. of Health by R129-98, eff. 3-25-99)

NAC 444.760 “Dosing tank” defined. ([NRS 439.200](#), [444.650](#)) “Dosing tank” means a watertight receptacle located between a septic tank and a disposal area equipped with an automatic siphon device or pumps designed to discharge sewage intermittently in the distribution lines in amounts proportioned to the capacity of such lines and to provide adequate rest periods between such discharges.

[Bd. of Health, Individ. Sewage Disposal Systems Reg. § 1.4, eff. 11-23-72]

NAC 444.7603 “Drainage channel” defined. ([NRS 439.200](#), [444.650](#)) “Drainage channel” means a natural or artificially created ditch that experiences intermittent water flow from storms or runoff from melting snow.

(Added to NAC by Bd. of Health by R100-07, eff. 10-31-2007)

NAC 444.7606 “Effluent” defined. ([NRS 439.200](#), [444.650](#)) “Effluent” means partially or completely treated sewage that flows out of a septic tank or an alternative treatment system.

(Added to NAC by Bd. of Health by R129-98, eff. 3-25-99)

NAC 444.7608 “Elevated mound system” defined. ([NRS 439.200](#), [444.650](#)) “Elevated mound system” means a soil absorption system that is elevated above the natural soil surface with a suitable fill material.

(Added to NAC by Bd. of Health by R129-98, eff. 3-25-99)

NAC 444.761 “Engineer” defined. ([NRS 439.200](#), [444.650](#)) “Engineer” means a person who is licensed by the State Board of Professional Engineers and Land Surveyors to practice professional engineering.

(Added to NAC by Bd. of Health by R129-98, eff. 3-25-99)

NAC 444.7616 “Graywater” defined. ([NRS 439.200](#), [444.650](#)) “Graywater” means untreated household wastewater that has not come into contact with toilet waste. The term includes, without limitation, used water from bathtubs, showers and bathroom washbasins, and water from machines for washing clothes and laundry tubs, but does not include wastewater from kitchen sinks or dishwashers.

(Added to NAC by Bd. of Health by R129-98, eff. 3-25-99)

NAC 444.762 “Health authority” defined. ([NRS 439.200](#), [444.650](#)) “Health authority” means the officers and agents of the Health Division, or of the local boards of health.

[Bd. of Health, Indiv. Sewage Disposal Systems Reg. § 1.5, eff. 11-23-72]

NAC 444.7624 “Holding tank” defined. ([NRS 439.200](#), [444.650](#)) “Holding tank” means a watertight, covered receptacle that is designed and constructed to:

1. Receive the discharge of sewage from a building sewer; and
2. Store that sewage until the sewage is removed by a septic tank pumping contractor.

(Added to NAC by Bd. of Health by R129-98, eff. 3-25-99)

NAC 444.763 “Impervious soil” defined. ([NRS 439.200](#), [444.650](#)) “Impervious soil” means a layer of earth that demonstrates a percolation rate which is greater than 120 minutes per inch.

(Added to NAC by Bd. of Health by R129-98, eff. 3-25-99)

NAC 444.764 “Individual sewage disposal system” defined. ([NRS 439.200](#), [444.650](#)) “Individual sewage disposal system” means a single system of sewage treatment tanks and effluent disposal facilities serving:

1. A single-family dwelling; or
2. In the case of a commercial system, one or more buildings that are not used as single-family dwellings.

[Bd. of Health, Indiv. Sewage Disposal Systems Reg. § 1.6, eff. 11-23-72]—(NAC A by R129-98, 3-25-99)

NAC 444.7642 “Irrigation ditch” defined. ([NRS 439.200](#), [444.650](#)) “Irrigation ditch” means a channel that is used to supply water to land used for ranching or farming. The term does not include a channel that contributes to a watercourse.

(Added to NAC by Bd. of Health by R129-98, eff. 3-25-99)

NAC 444.7644 “Kitchen unit” defined. ([NRS 439.200](#), [444.650](#)) “Kitchen unit” means an area of a structure which includes a cooking stove, a refrigerator and a sink.

(Added to NAC by Bd. of Health by R100-07, eff. 10-31-2007)

NAC 444.7646 “Lot” defined. ([NRS 439.200](#), [444.650](#)) “Lot” means a single or individual parcel of land that is legally recorded and upon which a disposal system or other project subject to the provisions of [NAC 444.750](#) to [444.8396](#), inclusive, is located.

(Added to NAC by Bd. of Health by R129-98, eff. 3-25-99)

NAC 444.765 “Multiple-dwelling structure” defined. ([NRS 439.200](#), [444.650](#)) “Multiple-dwelling structure” means one or more structures located on one lot which have separate units that are used as living quarters. The term includes, without limitation, a duplex, a triplex, a condominium and an apartment building.

(Added to NAC by Bd. of Health by R129-98, eff. 3-25-99)

NAC 444.7652 “Nitrogen removal wastewater treatment unit” defined. ([NRS 439.200, 444.650](#)) “Nitrogen removal wastewater treatment unit” means a system that receives sewage and, through biological denitrification, chemical reduction or ion exchange, reduces the nitrogen level of the effluent.

(Added to NAC by Bd. of Health by R129-98, eff. 3-25-99; A by R100-07, 10-31-2007)

NAC 444.7654 “Nonsewered toilet” defined. ([NRS 439.200, 444.650](#)) “Nonsewered toilet” means a toilet that is not connected to a sewage disposal system. The term includes, without limitation, a free standing portable toilet and a recreational vehicle and trailer equipped with holding tanks.

(Added to NAC by Bd. of Health by R129-98, eff. 3-25-99)

NAC 444.7656 “Percolation rate” defined. ([NRS 439.200, 444.650](#)) “Percolation rate” means the relatively constant rate, calculated in minutes per inch, at which clear water maintained at a constant depth will seep out of a standard-size test hole that has been previously saturated.

(Added to NAC by Bd. of Health by R129-98, eff. 3-25-99)

NAC 444.7658 “Percolation test” defined. ([NRS 439.200, 444.650](#)) “Percolation test” means a procedure to measure the percolation rate.

(Added to NAC by Bd. of Health by R129-98, eff. 3-25-99)

NAC 444.766 “Person” defined. ([NRS 439.200, 444.650](#)) “Person” includes governmental agencies. [Bd. of Health, Individ. Sewage Disposal Systems Reg. § 1.7, eff. 11-23-72]

NAC 444.7664 “Potable water” defined. ([NRS 439.200, 444.650](#)) “Potable water” means water that is satisfactory for drinking, culinary and other domestic purposes and which meets the applicable requirements of the health authority relating to potable water.

(Added to NAC by Bd. of Health by R129-98, eff. 3-25-99)

NAC 444.7666 “Pressure distribution system” defined. ([NRS 439.200, 444.650](#)) “Pressure distribution system” means a system of pipes that uses a pump, or a siphon if sufficient elevation head is available, to distribute effluent equally to a disposal field where the volume of effluent to be delivered to the disposal field is greater than the volume of the distribution piping.

(Added to NAC by Bd. of Health by R129-98, eff. 3-25-99)

NAC 444.7668 “Primary treatment unit” defined. ([NRS 439.200, 444.650](#))

1. “Primary treatment unit” means a system or receptacle that is designed and constructed to:

- (a) Receive the discharge of sewage from a building sewer;
- (b) Partially or completely treat the sewage; and
- (c) Discharge effluent for final disposal.

2. The term includes, without limitation, a septic tank, an aerobic wastewater treatment unit, a nitrogen removal wastewater treatment unit and any other alternative treatment system.

(Added to NAC by Bd. of Health by R129-98, eff. 3-25-99; A by R100-07, 10-31-2007)

NAC 444.767 “Residential system” defined. ([NRS 439.200, 444.650](#)) “Residential system” means an individual sewage disposal system that serves a single-family dwelling.

(Added to NAC by Bd. of Health by R129-98, eff. 3-25-99)

NAC 444.768 “Septic tank” defined. ([NRS 439.200, 444.650](#)) “Septic tank” means a watertight, covered receptacle designed and constructed to receive the discharge of sewage from a building sewer, to separate solids from the liquid, to digest organic matter and to store digested solids through a period of detention and to allow the clarified liquids to discharge for final disposal.

[Bd. of Health, Individ. Sewage Disposal Systems Reg. § 1.8, eff. 11-23-72]

NAC 444.770 “Septic tank pumping contractor” defined. ([NRS 439.200](#), [444.650](#)) “Septic tank pumping contractor” means any person engaged in the operation of removing and disposing of the solid and liquid contents of septic tanks, holding tanks, grease traps, grease interceptors, nonsewered toilets, or other sewage treatment or disposal facilities.

[Bd. of Health, Individ. Sewage Disposal Systems Reg. § 1.9, eff. 11-23-72]—(NAC A by R129-98, 3-25-99)

NAC 444.772 “Sewage” defined. ([NRS 439.200](#), [444.650](#)) “Sewage” means a combination of the liquid or water-carried wastes carried by pipes from:

1. Residences, including human excreta and liquid waste from kitchens and water closets;
2. Business buildings;
3. Institutions; and
4. Industrial establishments.

[Bd. of Health, Individ. Sewage Disposal Systems Reg. § 1.10, eff. 11-23-72]—(NAC A by R129-98, 3-25-99)

NAC 444.775 “Single-family dwelling” defined. ([NRS 439.200](#), [444.650](#))

1. “Single-family dwelling” means one or more buildings that:
 - (a) Are designed and used as a home by the occupants of the buildings;
 - (b) Include a bathroom unit and a kitchen unit; and
 - (c) Are served by an individual sewage disposal system.
 2. The term does not include an accessory structure or a multiple-dwelling structure.
- (Added to NAC by Bd. of Health by R129-98, eff. 3-25-99; A by R100-07, 10-31-2007)

NAC 444.776 “Soil absorption system” defined. ([NRS 439.200](#), [444.650](#)) “Soil absorption system” means any system that utilizes the soil for subsequent absorption and treatment of the septic tank effluent.

[Bd. of Health, Individ. Sewage Disposal Systems Reg. § 1.11 eff. 11-23-72]

NAC 444.7764 “Special event” defined. ([NRS 439.200](#), [444.650](#)) “Special event” means a public gathering that is temporary and held for a specific purpose, and which:

1. Includes, as part of the event, the preparation and serving of food by a food establishment or a temporary food establishment, as those terms are defined in [NRS 446.020](#) and [446.067](#), respectively; or
 2. Due to the nature of the event, requires that restroom facilities be provided.
- (Added to NAC by Bd. of Health by R129-98, eff. 3-25-99)

NAC 444.777 “Watercourse” defined. ([NRS 439.200](#), [444.650](#)) “Watercourse” means the bed or channel of a waterway. The term includes, without limitation, a river, creek, stream, pond or lake, but does not include an irrigation ditch or drainage channel.

(Added to NAC by Bd. of Health by R129-98, eff. 3-25-99; A by R100-07, 10-31-2007)

NAC 444.7772 “Water table” defined. ([NRS 439.200](#), [444.650](#)) “Water table” means the level in saturated soil at which the hydraulic pressure is zero.

(Added to NAC by Bd. of Health by R129-98, eff. 3-25-99)

NAC 444.778 Purpose. ([NRS 439.200](#), [444.650](#))

1. The purpose of [NAC 444.750](#) to [444.8396](#), inclusive, is to protect the health of the individual family and the community and to prevent the occurrence of nuisances by safely disposing of all human and domestic wastes.
2. To accomplish satisfactory results, these wastes must be disposed of so that they will not:
 - (a) Contaminate any drinking water supply.

- (b) Create a public health hazard by being accessible to insects, rodents or other possible carriers which may come in contact with food or drinking water.
 - (c) Create a nuisance due to odor or unsightly appearance.
 - (d) Contaminate any body of water.
 - (e) Violate laws or regulations governing sewage disposal.
- [Bd. of Health, Indiv. Sewage Disposal Systems Reg. Purpose, eff. 1962; A 11-23-72]—(NAC A by R129-98, 3-25-99)

NAC 444.780 Interpretation. ([NRS 439.200](#), [444.650](#)) If more than one interpretation exists for a provision of [NAC 444.750](#) to [444.8396](#), inclusive, the more restrictive interpretation must be followed.

[Bd. of Health, Indiv. Sewage Disposal Systems Reg. § 2.2, eff. 11-23-72]—(NAC A by R129-98, 3-25-99)

NAC 444.782 Severability. ([NRS 439.200](#), [444.650](#)) If any of the provisions of [NAC 444.750](#) to [444.8396](#), inclusive, or any application thereof to any person, thing or circumstance is held invalid, it is intended that such invalidity not affect the remaining provisions, or their application, that can be given effect without the invalid provision or application.

[Bd. of Health, Indiv. Sewage Disposal Systems Reg. § 3.1, eff. 11-23-72]—(NAC A by R129-98, 3-25-99)

NAC 444.7825 Adoption by reference of certain publications; revision of certain publications after adoption. ([NRS 439.200](#), [444.650](#))

1. The following provisions and publications are hereby adopted by reference:

(a) Standards 40, 41 and 46 of NSF International, in the form most recently published by NSF International. These standards are available from NSF International by telephone at (800) 699-9277, for the price of \$95 each.

(b) *Standard Specifications for Public Works Construction*, in the form most recently published by the Regional Transportation Commission of Washoe County, Washoe County, the City of Sparks, the City of Reno, Carson City and the City of Yerington. This publication is available free of charge at the Internet address <http://www.rtcwashoe.com/streets/orangebook/>.

(c) *The Uniform Plumbing Code*, in the form most recently published by the International Association of Plumbing and Mechanical Officials. This publication is available from the International Association of Plumbing and Mechanical Officials by telephone at (800) 854-2766, for the price of \$93.

(d) *The Design Manual for On-Site Wastewater Treatment and Disposal Systems*, which is published by the Environmental Protection Agency (reference document number PB83-219907). This document is available by mail from the National Technical Information Service, 5285 Port Royal Road, Springfield, Virginia 22161, or by telephone at (800) 553-6847, for the price of \$97.50, plus \$5 for shipping and handling.

2. The State Board of Health will review each revision of the publications adopted by reference pursuant to paragraphs (a), (b) and (c) of subsection 1 to ensure its suitability for this State. If the Board determines that a revision is not suitable for this State, the Board will hold a public hearing to review its determination within 6 months after the date of the publication of the revision and give notice of that hearing. If, after the hearing, the Board does not revise its determination, the Board will give notice within 30 days after the hearing that the revision is not suitable for this State. If the Board does not give such notice, the revision becomes part of the publication adopted by reference.

(Added to NAC by Bd. of Health by R129-98, eff. 3-25-99; A by R100-07, 10-31-2007)

NAC 444.783 Approval of alternate methods of compliance. ([NRS 439.200](#), [444.650](#)) The health authority may grant an owner of an individual sewage disposal system approval for an alternate method of compliance with any provision of this chapter if the alternate method of compliance:

- 1. Will not be detrimental to the public health;
- 2. Is justified by an engineer if, because of site conditions or proposed alternative treatments, the health authority requires the alternate method of compliance to be justified by an engineer;
- 3. Involves an advance in technology, improvement in materials, or alternative method of construction

or operation; and

4. Does not conflict with the provisions of subsection 1 of [NAC 444.778](#) and paragraphs (a) to (d), inclusive, of subsection 2 of [NAC 444.778](#).

(Added to NAC by Bd. of Health by R129-98, eff. 3-25-99; A by R100-07, 10-31-2007)

Individual Sewage Disposal Systems

NAC 444.784 Permits: Approval for new construction required; request for approval; nature and duration. ([NRS 439.200](#), [444.650](#))

1. Approval must be obtained from the administrative authority to construct, alter or extend an individual sewage disposal system. This approval for new construction is required before any building permit may be issued for any structure which requires an individual sewage disposal system.

2. The request for approval must include:

(a) The name, address and current phone number of the applicant.

(b) The legal description of the property, including the lot and block number, township, range, section and assessor's parcel number, on which construction, alteration or extension is proposed.

(c) A plot plan.

3. The plot plan must include:

(a) The title and date of the plan and the signature of the owner or his or her representative.

(b) A map of the area in which the individual sewage disposal system will be located that shows the location of the roads and streets.

(c) The location and distance to well and sewage systems on surrounding lots. If the lots are vacant, the plot plan must so indicate.

(d) The direction of north clearly indicated.

(e) The distance within 500 feet to any watercourse indicated, including, without limitation, any pond, lagoon or stream. If there are no watercourses, the plot plan must so indicate.

(f) The location of each percolation test hole and boring test hole.

(g) The location and depth of each proposed or actual well, including the depth of casing or surface grout seal.

(h) Each component of the individual sewage disposal system, which must be properly marked and located at specified distances.

(i) The distance to city sewers. If there are none, the plot plan must so indicate.

(j) The distance of each well and soil absorption system to the property line.

(k) The scale to which the plan is drawn, such as 1 inch = 30 feet, 40 feet, 50 feet, 60 feet, etc.

(l) The number of bedrooms in the single-family dwelling.

(m) The capacity of the septic tank.

(n) The maximum slope across the absorption system area.

(o) The dimensions of the lot.

(p) The depth, length, width and spacing of any absorption trenches.

(q) The location of the water supply lines, building sewer lines and other underground utilities.

(r) The location of the structures, paved areas, driveways, trees and patios.

(s) The location of the source of water to be used by the individual sewage disposal system, including, without limitation, a well or other source approved by the administrative authority.

(t) The location of the reserve absorption area, which must be of a size not less than the size of the primary absorption area.

4. Soil characteristics, depth to water table and bedrock, percolation test results and design specifications must accompany the plot plan.

5. A permit issued under [NAC 444.750](#) to [444.8396](#), inclusive, is deemed to be a temporary permit to operate an individual sewage disposal system. The operating permit is valid until:

(a) The individual sewage disposal system fails; or

(b) A community sewerage system:

(1) Is installed and available to service the area; and

(2) Passes through or is in physical contact with the property line or is located adjacent to the property

in a street or right-of-way that abuts the property line.

6. For the purposes of this section, an individual sewage disposal system shall be deemed to have failed if:

(a) A condition or malfunction occurs in the individual sewage disposal system, or in the operation of the system, that threatens the public health by inadequately treating sewage or by creating a potential for direct or indirect contact between sewage and the public, including, without limitation:

- (1) Sewage on the ground;
- (2) A backup of sewage into a structure that is caused by the slow soil absorption of effluent;
- (3) Sewage leaking from a septic tank, dosing tank, holding tank or collection system; and
- (4) Effluent contaminating the groundwater or surface water; or

(b) The operator of the system fails to comply with the requirements of the permit issued to operate the system.

[Bd. of Health, Indiv. Sewage Disposal Systems Reg. §§ 4.1-4.2 + Figures 7-9, eff. 11-23-72]—(NAC A by R129-98, 3-25-99; R100-07, 10-31-2007)

NAC 444.786 Permits: Denials; procedure for review of actions taken by health authority; appeals; validity and extension. ([NRS 439.200](#), [444.650](#))

1. Except as otherwise provided in this subsection, an application for a permit for an individual sewage disposal system submitted to the health authority must be denied in writing and the reasons specified therefor if:

(a) The health authority determines that the proposed installation will not comply with [NAC 444.750](#) to [444.8396](#), inclusive;

(b) A community sewerage system is available and passes through or is in physical contact with the property line or is located adjacent to the property in a street or right-of-way that abuts the property line; or

(c) The proposed individual sewage disposal system is within the service area of a sewer company which provides sewage services that are subject to the jurisdiction of the Public Utilities Commission of Nevada or any local governmental entity, including, without limitation, a general improvement district, that has jurisdiction over the sewer services in that geographical area. A permit may be granted by the health authority if the sewer company approves in writing the construction of the individual sewage disposal system within its service area or jurisdiction.

2. A person who has reason to believe that an action taken by the health authority pursuant to [NAC 444.750](#) to [444.8396](#), inclusive, is incorrect or based on inadequate knowledge may, within 10 business days after receiving notice of the action, request an informal discussion with the employee responsible for the action and the immediate supervisor of the employee.

3. If the informal discussion does not resolve the problem, the aggrieved person may, within 10 business days after the date scheduled for the informal discussion, submit a written request to the Bureau for an informal conference. The informal conference must be scheduled for a date, place and time mutually agreed upon by the aggrieved person and the Bureau, except that the informal conference must be held no later than 60 days after the date on which the Bureau received the written request.

4. Except as otherwise provided in subsection 5, the determination of the Bureau resulting from the informal conference cannot be appealed and is the final remedy available to the aggrieved person.

5. An applicant for or holder of a permit issued pursuant to [NAC 444.750](#) to [444.8396](#), inclusive, who is aggrieved by an action of the health authority relating to the denial of an application for, or the suspension or revocation of, such a permit may appeal that action in accordance with [NAC 439.300](#) to [439.395](#), inclusive, after exhausting the informal procedures set forth in this section, except that the Bureau may waive the informal procedures, or any portion thereof, by giving written notice to the aggrieved person.

6. A permit is void 12 months after the date of issuance if the proposed construction, alteration or extension of the individual sewage disposal system is not completed within that period. Upon the request of the holder of the permit, an extension of the permit may be granted in increments of 1 year if the appropriate fees are paid and the proposed plans meet the requirements of [NAC 444.750](#) to [444.8396](#), inclusive.

7. As used in this section, "Bureau" means the Bureau of Health Protection Services of the Health Division or its successor.

[Bd. of Health, Indiv. Sewage Disposal Systems Reg. §§ 4.3-4.5, eff. 11-23-72]—(NAC A 10-30-97;

R129-98, 3-25-99; R100-07, 10-31-2007)

NAC 444.788 Inspections. (NRS 439.200, 444.650)

1. Inspections may be required of the system materials and the trench before the trench is filled with aggregate or rock. Inspections by the administrative authority may be required before the sewer line, septic tank and soil absorption system may be covered. Inspections of alternative systems are required at intervals specified in [NAC 444.750](#) to [444.8396](#), inclusive. If an engineer verifies that an individual sewage disposal system was constructed according to the plans approved by the administrative authority, the administrative authority may waive its inspection of the system.

2. Until the individual sewage disposal system has passed inspection by the administrative authority and a permit or other type of approval authorizing use of the system has been issued, there must be no use of the system, no occupancy of the building and no permanent electrical power connection to the property.

3. In an area in which there is a local administrative authority, review of designs and inspections for residential systems may be performed by city, district or county building inspectors.

[Bd. of Health, Indiv. Sewage Disposal Systems Reg. Notice, eff. 1962; A and numbered as §§ 6.1-6.3, 11-23-72]—(NAC A by R129-98, 3-25-99; R100-07, 10-31-2007)

NAC 444.790 Lot size. (NRS 439.200, 444.650)

1. A minimum area of 1 acre (43,560 square feet), including public streets and alleys or other public rights-of-way, lands or any portion thereof abutting on, running through or within a building site, is required for the installation of an individual sewage disposal system on a lot served by a well.

2. For a lot that is a part of a tentative map that is approved before January 1, 2000, a minimum area of 1/4 acre (10,890 square feet), including public streets or alleys or other public rights-of-way, lands or any portions thereof abutting on, running through or within a building site, is required for the installation of an individual sewage disposal system on a lot served by a community water supply.

3. For a lot that is part of a tentative map that is approved on or after January 1, 2000, a minimum area of 1/2 acre (21,780 square feet), including public streets or alleys or other public rights-of-way, lands or any portions thereof abutting on, running through or within a building site, is required for the installation of an individual sewage disposal system on a lot served by a community water supply.

[Bd. of Health, Indiv. Sewage Disposal Systems Reg. Note, eff. 1962; A and numbered as §§ 7.1-7.3, 11-23-72]—(NAC A 10-22-93; R129-98, 3-25-99; R100-07, 10-31-2007)

NAC 444.792 Location. (NRS 439.200, 444.650)

1. Except as otherwise provided in this section, an individual sewage disposal system must be located on the same lot as the building or structure that the system serves. The administrative authority may approve the use of a part of an abutting lot to provide additional space for an individual sewage disposal system or any part thereof, if the owner of the individual sewage disposal system can show:

(a) Proper cause, including, without limitation, a legal right of the owner to use the abutting land as a result of a transfer of ownership of the abutting lot or an easement to use the abutting lot; and

(b) Use of the abutting lot for the individual sewage disposal system does not violate any other requirement of [NAC 444.750](#) to [444.8396](#), inclusive.

2. The minimum horizontal separations that must be maintained between the perimeter of the components of an individual sewage disposal system and the following features are:

Minimum horizontal distance, in clear, required from:	Septic tank	Disposal field (shallow)
Building or structure	8¢	8¢
Property lines	10¢	10¢

Water supply wells (sealed to 50 feet)	100¢	100¢
Water supply wells (not sealed to 50 feet)	100¢	150¢
Public water supply wells	150¢	150¢
Streams or watercourses	100¢	100¢
Drainage channels	25¢	25¢
Large trees or shrubs	10¢	10¢
Disposal fields	5¢	—
Community water main line	10¢	25¢
Individual water service line	10¢	25¢

[Bd. of Health, Indiv. Sewage Disposal Systems Reg. §§ 8.1-8.2.4 & Table 4, eff. 11-23-72 + Lot plan, eff. 1962; A and renumbered as Figure 1, 11-23-72]—(NAC A by R129-98, 3-25-99; R100-07, 10-31-2007)

NAC 444.794 Slope requirements. ([NRS 439.200](#), [444.650](#))

1. For lots with slopes in excess of 20 percent, soil absorption trenches must, at the level of the distribution pipe, be a minimum of 20 feet horizontally from the face of the slope or ground surface as shown in subsection 4.
2. Additional restrictions may be imposed where conditions relating to percolation and slope so indicate.
3. A stepped network of trenches utilizing relief lines which follows the contours of the slope may be used upon the approval of the health authority.
4. Diagram of a slope:

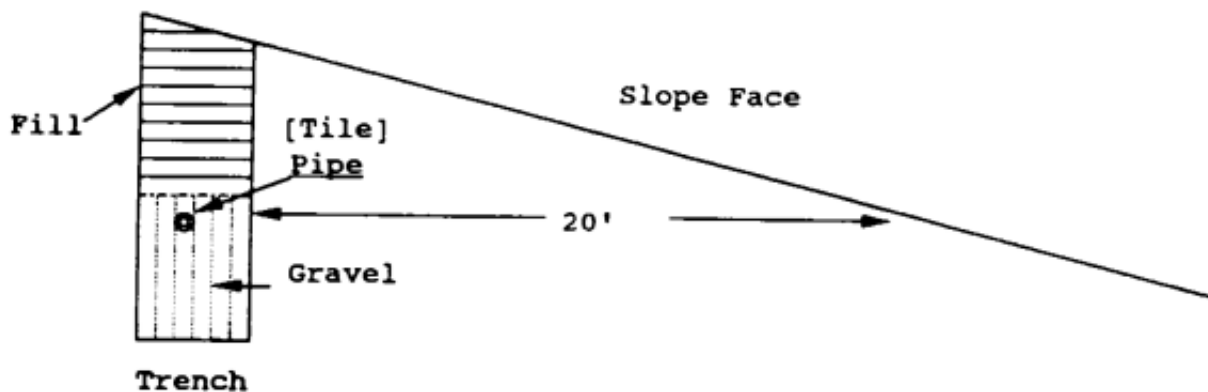

[Bd. of Health, Indiv. Sewage Disposal Systems Reg. §§ 9.1-9.3 + Figure 10, eff. 11-23-72]—(NAC A by R129-98, 3-25-99)

NAC 444.796 Performance of percolation test by property owner; verification of certain data by engineer. ([NRS 439.200](#), [444.650](#))

1. Data from percolation tests from a minimum of two test holes in the area of the proposed soil

absorption system is required. The property owner shall perform a percolation test in accordance with [NAC 444.796](#) to [444.7968](#), inclusive.

2. The hole must be dug or bored to the proposed depth of the absorption trench. The hole must have vertical sides and have a horizontal dimension of 4 to 12 inches. The bottom and sides of the hole must be carefully scratched with a sharp-pointed instrument to expose the natural soil interface. All loose material must be removed from the bottom of the hole which must then be covered with 2 inches of coarse sand or gravel when necessary to prevent scouring. Any soil which has sloughed into the hole before or during the percolation test must be removed.

3. The health authority may require an engineer to verify data relating to the depth of the high groundwater and bedrock, or areas subject or susceptible to flooding, the ground slope, and the results of percolation tests. Verification of maximum high groundwater includes, without limitation, a morphological study of soil conditions with particular reference to soil color and sequence of horizons.

4. If the natural soil condition has been altered by filling or other attempts to improve wet areas, the health authority may require the verification by the engineer to include observation of high groundwater levels under saturated soil conditions.

5. If the natural soil condition has been altered by filling or other attempts to improve the percolation rate of the soil, the health authority may require the verification by the engineer to include a determination of whether the fill material is suitable for an individual sewage disposal system.

[Bd. of Health, Indiv. Sewage Disposal Systems Reg. §§ 1-4, eff. 1962; A and renumbered as §§ 10.1-10.2.2, 11-23-72]—(NAC A by R129-98, 3-25-99)

NAC 444.7962 Determination of appropriate percolation test procedure. ([NRS 439.200](#), [444.650](#)) In conducting a percolation test, the following flow chart must be used to determine which test procedure to follow:

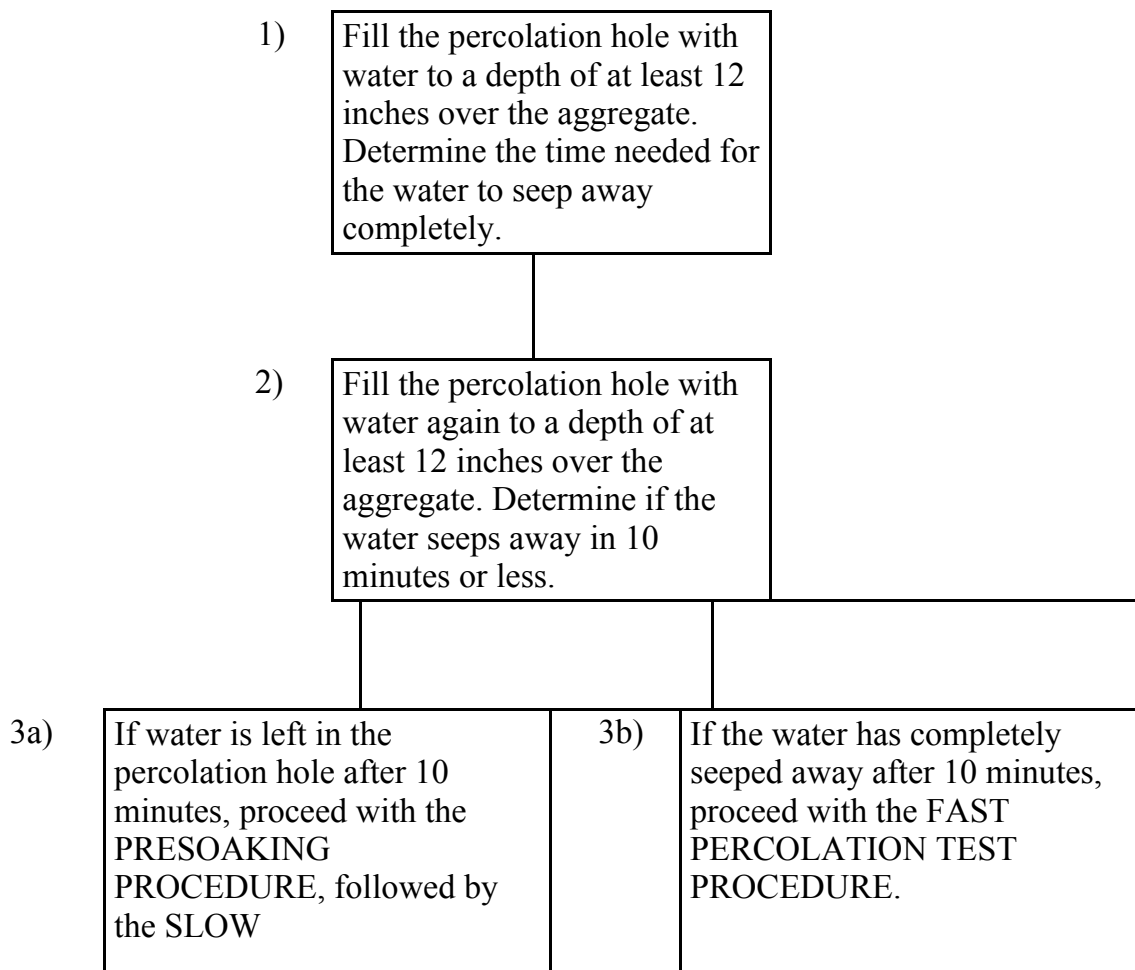

PERCOLATION TEST
PROCEDURE.

(Added to NAC by Bd. of Health by R129-98, eff. 3-25-99)

NAC 444.7964 Fast percolation test procedure. ([NRS 439.200](#), [444.650](#)) The following flow chart illustrates the fast percolation test procedure:

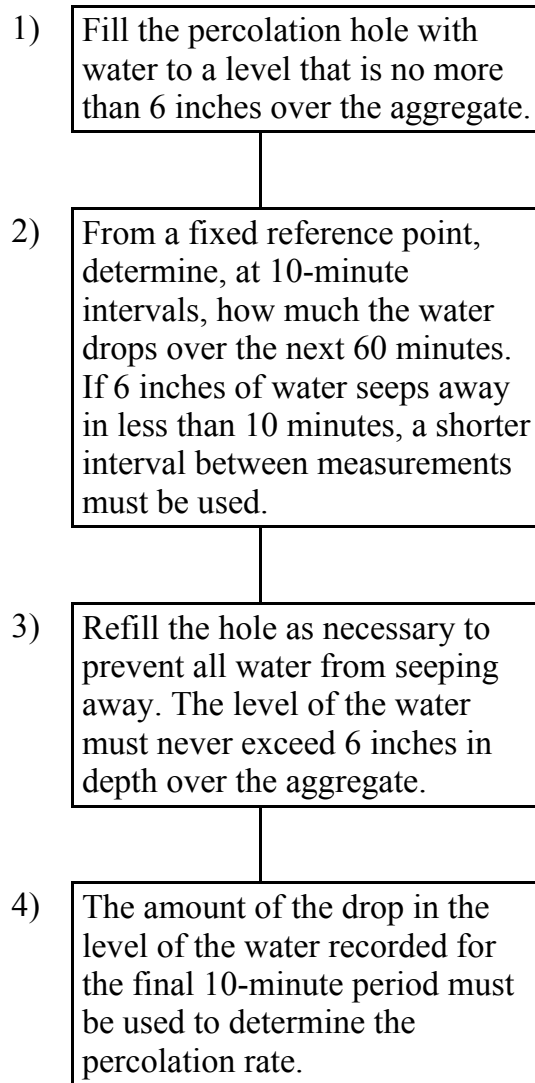

NOTE: The minimum time in which a fast percolation test may be completed is 1 hour. The level of the water must never exceed 6 inches over the aggregate during a fast percolation test.

(Added to NAC by Bd. of Health by R129-98, eff. 3-25-99)

NAC 444.7966 Presoaking procedure for slow percolation test. ([NRS 439.200](#), [444.650](#)) The following flow chart illustrates the presoaking procedure for a slow percolation test:

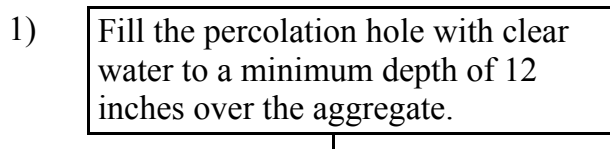

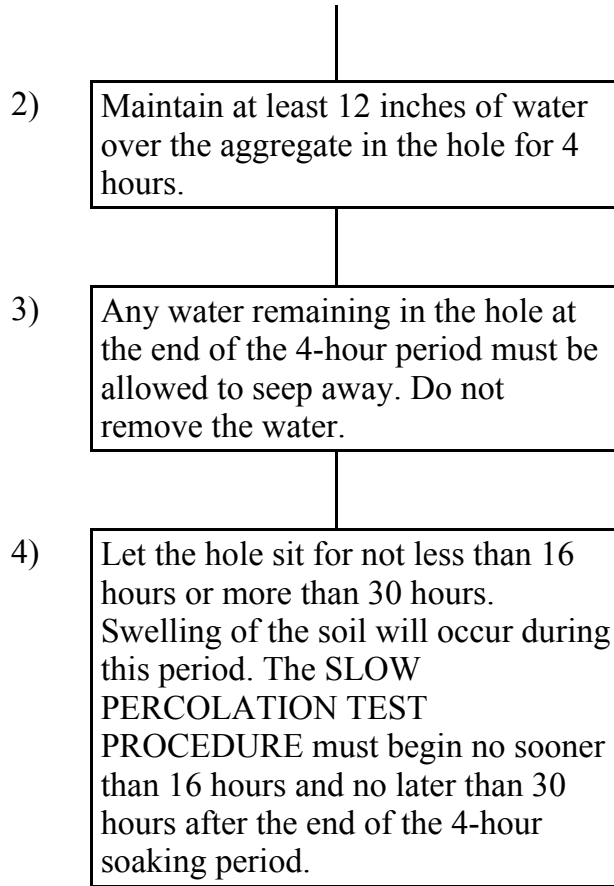

(Added to NAC by Bd. of Health by R129-98, eff. 3-25-99)

NAC 444.7968 Slow percolation test procedure. ([NRS 439.200](#), [444.650](#)) The following flow chart illustrates the slow percolation test procedure:

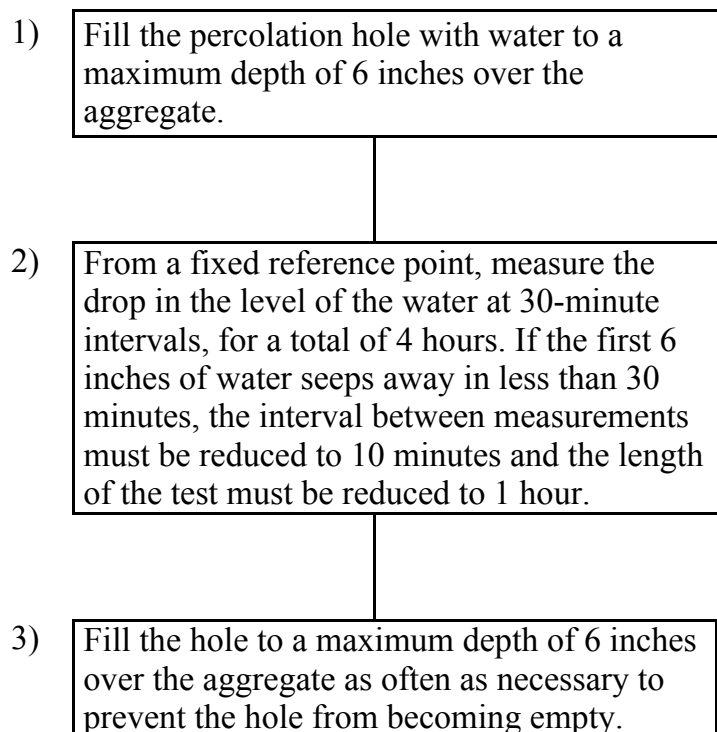

- 4) The amount of the drop in the level of the water during the last interval must be used to determine the percolation rate, except that if two successive measurements do not vary more than 1/16 inch, the test may be stopped and the percolation rate may be determined.

(Added to NAC by Bd. of Health by R129-98, eff. 3-25-99)

NAC 444.797 Sample form for percolation test. ([NRS 439.200](#), [444.650](#)) The following is a sample form for a percolation test:

Hole # _____	Percolation Rate: _____ Minutes/Inch			
Depth From Native Ground Surface That Percolation Test Was Conducted:				
Presoak Start Time:			Presoak End Time:	
Number of Hours That Soil Was Presoaked:				
Notes:				
TIME	DEPTH TO WATER	INTERVAL	DROP OF WATER IN INCHES	MIN/INCH

NOTE: TWO PERCOLATION TESTS ARE REQUIRED FOR EACH ABSORPTION AREA. THE LAST READING IS TO BE USED TO DETERMINE THE PERCOLATION RATE.

(Added to NAC by Bd. of Health by R129-98, eff. 3-25-99)

NAC 444.7972 Sample log for profile of soil. ([NRS 439.200](#), [444.650](#)) The following is a sample log

A DEPTH THAT IS AT LEAST 5 FEET BELOW THE BOTTOM OF THE ABSORPTION TRENCH MUST BE PROVIDED IN THE APPROPRIATE SPACE IN THE LOG FOR THE PROFILE OF THE SOIL.

(Added to NAC by Bd. of Health by R129-98, eff. 3-25-99)

NAC 444.798 Approved cleanout; building sewer. ([NRS 439.200](#), [444.650](#))

1. An approved cleanout must be installed on the building sewer line. The cleanout must be located within 3 feet of the structure or, if the cleanout cannot be placed within 3 feet of the structure, as close as practicable to the structure. At least one additional cleanout must be placed for each 100-foot increment of sewer line and for each aggregate change in the direction of the sewer line in excess of 90 degrees.

2. The building sewer between the house and the individual sewage disposal system must be approved pipe made of cast-iron, concrete, cement-asbestos or polyvinylchloride, with watertight joints.

3. Except as otherwise provided in this section, the run of the building sewer, when practical, must be at a uniform slope of not less than 1/4 inch per foot from the building toward the point of disposal. If approved by the administrative authority, a building sewer which is:

(a) Not less than 4 inches or more than 6 inches in diameter may have a slope of not less than 1/8 inch per foot.

(b) Eight inches or more in diameter may have a slope of not less than 1/16 inch per foot.

4. A building sewer must be laid on undisturbed earth or well-compacted material. The top of the building sewer must be 12 inches or more below the final grade.

5. The following is a diagram of an individual sewage disposal system:

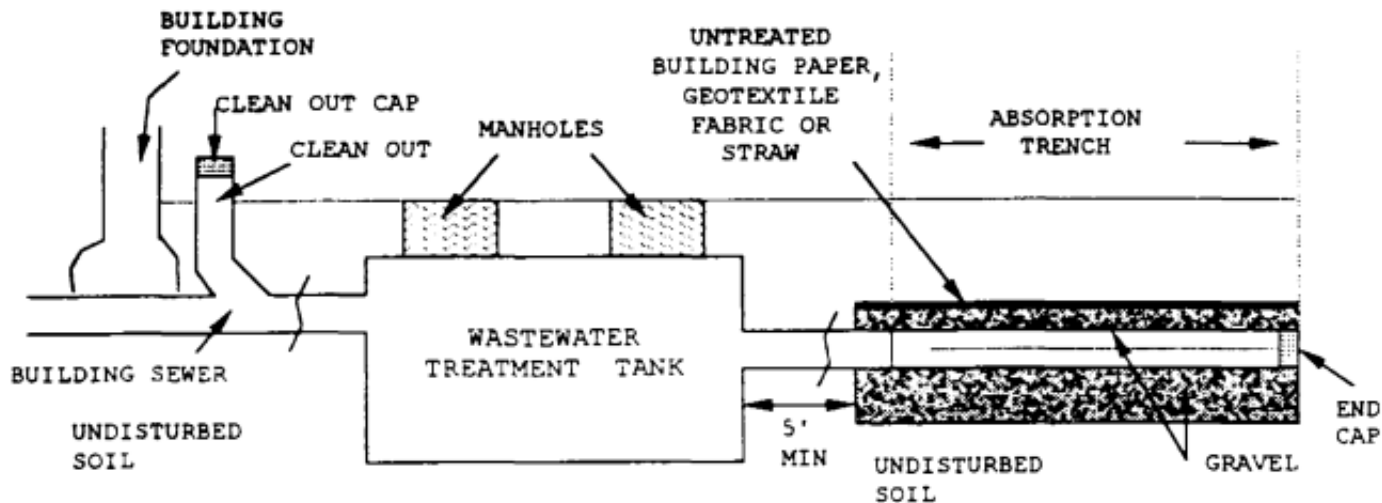

[Bd. of Health, Individ. Sewage Disposal Systems Reg. § 11.1 + Figure 6, eff. 11-23-72]—(NAC A by R129-98, 3-25-99; R100-07, 10-31-2007)

REVISER'S NOTE.

The regulation of the State Board of Health filed with the Secretary of State on March 25, 1999 (LCB File No. R129-98), which amended this section, contains the following provision not included in NAC:

“Sec. 118. The amendatory provisions of section 107 of this regulation [[NAC 444.798](#)] apply only to building sewer lines that are constructed or repaired on or after the effective date of this regulation [March 25, 1999].”

NAC 444.804 Construction of septic tank. ([NRS 439.200](#), [444.650](#))

1. Plans for a septic tank which have not been previously approved by the health authority must be submitted to the health authority for approval. The plans must show all dimensions, reinforcing, structural calculations and such other pertinent data as may be required pursuant to [NAC 444.804](#) to [444.810](#), inclusive. A septic tank must be constructed of solid durable materials, and must not be subject to excessive corrosion or decay. Acceptable materials include concrete, coated steel, polyethylene, fiberglass and any other material approved by the health authority.

2. A septic tank must have two compartments. The capacity of the inlet compartment must be not less than 2/3 of the total capacity of the tank. The inlet compartment must be at least 3 feet in width and 5 feet in length. The depth of the liquid in the inlet compartment must be not less than 30 inches or more than 72 inches. The secondary compartment must have a minimum capacity of 300 gallons and a maximum capacity equal to 1/3 of the total capacity of the septic tank. If the septic tank has a total capacity of more than 1,500 gallons, the secondary compartment must be 5 feet or more in length.

3. Adequate access must be provided into each compartment to facilitate inspection and cleaning of the tank. Each compartment must have at least one manhole to provide access into the compartment. A manhole must have a minimum diameter of 20 inches. If the inlet compartment is longer than 12 feet, an additional manhole must be provided over the baffle or partition wall.

4. An inlet pipe and an outlet pipe must each be at least 4 inches in diameter. The top of the tee or baffle for both the vented inlet and the vented outlet must extend at least 4 inches above the level of the liquid. The bottom of the tee or baffle for both the vented inlet and vented outlet must extend at least 12 inches below the level of the liquid. The invert of the inlet pipe must be at least 2 inches above the invert of the outlet pipe.

5. A manufactured septic tank must be permanently and legibly marked as to the manufacturer, total tank capacity, liquid capacity and general location of the manufacturing firm.

6. A partition or baffle between compartments must be made of solid, durable material, must extend at least 4 inches about the liquid level, and must be vented to allow for the free passage of gas between the compartments. A down-turned 90-degree inverted fitting, which is at least 4 inches in diameter, must be installed on the side of the baffle or partition for the inlet compartment. The inverted fitting must be set so that the bottom of the fitting is placed at a level that is equal to not less than 50 percent or more than 75 percent of the height of the liquid level in the tank. A baffle or partition may not be made of wood.

7. A septic tank must be structurally designed to withstand all anticipated loads of dirt or other substances, must be installed so that the tank is level and must be installed on a solid bed. The cover of a septic tank must be capable of supporting a load of dirt of not less than 300 pounds per square foot.

8. All aggregates fine and coarse, other than lightweight aggregate, must conform to specifications outlined by the *Standard Specifications for Public Works Construction* adopted by reference pursuant to [NAC 444.7825](#).

9. Aggregates must be free of deleterious substances which may react with oxidized hydrogen sulfide. Aggregates must be graded in such a manner as to produce a homogeneous concrete mix. All materials must be accurately weighed at a central batching facility for mixing.

10. All cement must be Portland cement conforming to the *Standard Specifications for Public Works Construction* adopted by reference pursuant to [NAC 444.7825](#). Cement content must be sufficient to produce a minimum strength of 3,000 PSI, or other design strengths required.

11. All concrete must be handled from the mixer or transport vehicle to the place of final deposit in a continuous manner, as rapidly as practicable, and without segregation or loss of ingredients, until the approved construction is completed. Each pour must be compacted by mechanical internal or external-vibrating equipment. Duration of the vibration cycle must be limited to the time necessary to produce satisfactory consolidation without causing objectionable segregation.

12. All reinforcing steel, including welded wire mesh, must be of the size and in the location as shown on the plans. The reinforcing steel must be sufficiently tied to withstand any displacement during the pouring operation. All bars must be made of intermediate or hard graded billet steel. The health authority may inspect the tank reinforcing steel before any concrete is poured.

13. The side walls of a septic tank must extend at least 9 inches above the level of the liquid. The interior ceiling of the septic tank must be at least 2 inches above the top of the tee or baffle for the vented inlet and the top of the tee or baffle for the vented outlet.

14. A septic tank must be watertight. A manufacturer of a septic tank shall test the tank for watertightness by one of the following methods:

(a) Water testing by sealing the outlets, filling the septic tank to its operational level and allowing the tank to stand not less than 8 hours or more than 10 hours. If, after this period, there is a measurable loss of water, the tank must be refilled and allowed to stand for an additional 8 to 10 hours. If, after the second period, there is a measurable loss, the tank must be rejected. A septic tank may not be rejected solely because of the appearance of damp spots on the exterior of the tank. A tank that has been rejected must be repaired and

tested before it may be used in an individual sewage disposal system.

(b) Vacuum testing by sealing all of the inlets, outlets and accesses and introducing a vacuum of 4 inches of mercury. If the vacuum drops during the first 5 minutes, the vacuum must be brought back up to 4 inches of mercury. If the septic tank fails to hold the vacuum at 4 inches of mercury during the second 5-minute period, the tank must be rejected. A tank that has been rejected must be repaired and tested before it may be used in an individual sewage disposal system.

(c) An alternative testing procedure approved by the health authority.

15. The health authority may require a manufacturer of a septic tank to demonstrate the watertight integrity of the septic tank.

16. A septic tank must meet the requirements set forth in the *Uniform Plumbing Code* for the construction of septic tanks.

17. The following is a diagram of a typical two-compartment septic tank:

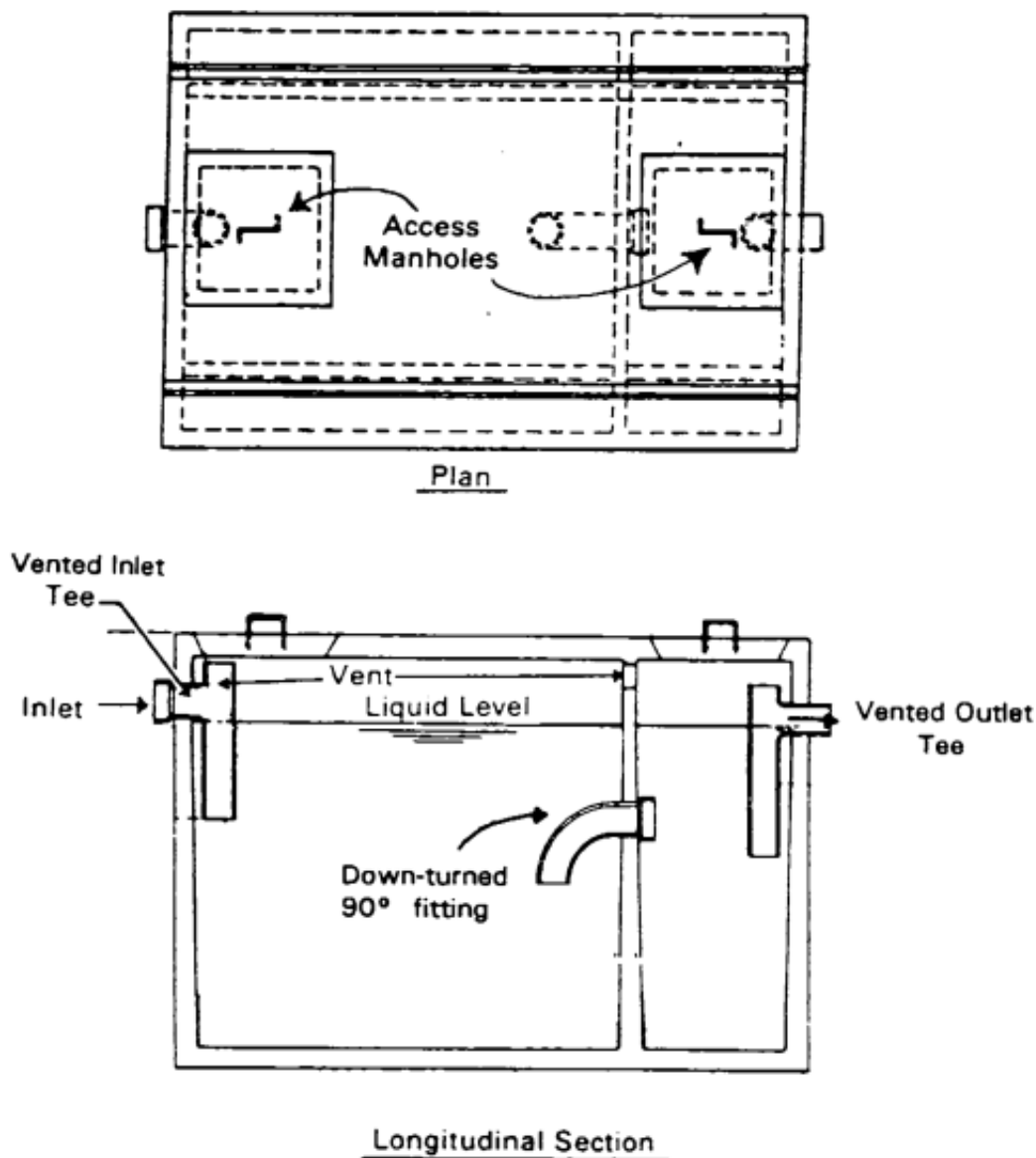

[Bd. of Health, Individ. Sewage Disposal Systems Reg. § 1 of Note, eff. 1962; A and renumbered as § 12.6.2, 11-23-72 & renumbered as §§ 12.6.1, 12.6.3-12.6.11, part 12.7, & part 12.8, eff. 11-23-72]—(NAC A by R129-98, 3-25-99)

NAC 444.806 Precast septic tanks. ([NRS 439.200](#), [444.650](#)) For precast septic tanks:

1. All forms used in placing concrete must be smooth, and sufficiently designed and braced to maintain their alignment under the pressure of the concrete during placing.
 2. Precast sections must be set evenly in a full bed of sealant. Excessively mortared joints must be trimmed flush. Sealants used between the joints are at the manufacturer's discretion, unless otherwise specified by the health authority. If grout is used, it must consist of two parts sand to one part cement with sufficient water added to make the grout flow under its own weight. The grout must be poured into a water-soaked groove, and filled to the top of the groove in the previously set section. If mastic joint compound is used, it must be placed along the walls of the groove unless a double amount of mastic joint compound is to be used as a further precaution against leakage. If a double amount of mastic joint compound is used, the mastic sealant must be placed on the two shoulders of the groove. If polyurethane is used, it must be mixed as directed by the manufacturer of the polyurethane and placed in the groove. The next section must be placed while the foaming reaction for the previous section is still in process.
 3. For the purpose of early reuse of forms, the concrete may be steam cured. Other curing by means of water spraying or a membrane curing compound may be used.
- [Bd. of Health, Indiv. Sewage Disposal Systems Reg. §§ 12.6.12-12.6.12.3, eff. 11-23-72]—(NAC A by R129-98, 3-25-99)

NAC 444.808 Built-in-place septic tanks. ([NRS 439.200](#), [444.650](#)) A built-in-place septic tank must be designed by an engineer and constructed in accordance with [NAC 444.804](#) to [444.810](#), inclusive. The design plans for a built-in-place septic tank must be submitted to the health authority for review and approval before construction on the tank may begin. Upon completion of the construction of the built-in-place septic tank, the engineer who designed the tank shall submit written verification to the health authority that the septic tank was constructed according to the approved plans.

[Bd. of Health, Indiv. Sewage Disposal Systems Reg. §§ 12.6.13-12.6.13.3, eff. 11-23-72]—(NAC A by R129-98, 3-25-99)

NAC 444.810 Coated steel septic tanks. ([NRS 439.200](#), [444.650](#))

1. Coated steel septic tanks must be made of commercial grade sheet steel of good welding quality and must have a bituminous coating applied in accordance with subsection 2. Only new materials may be used, and the thickness of the sheet must be Number 12 manufacturer's standard gage (.109 inches) or heavier. The tanks must be so constructed as to withstand all anticipated earth or other loads.

2. The coating must be composed of bituminous-base materials that are impervious to water and resistant to sulfuric and sulfurous acids of concentrations encountered in the normal operation of septic tanks. The coating systems which are acceptable must be applied as follows:

(a) A hot-dipped asphalt coating may be applied to the bare metal or over an asphalt primer, followed by a coal-tar-base emulsion coating applied to all interior surfaces of the tank above a level at least 8 inches below the invert of the outlet pipe.

(b) A cold-application, coal-tar-base coating may be applied to the bare metal or over a coal-tar-primer, followed by a second application of the coating to all interior surfaces of the tank above a level at least 8 inches below the invert of the outlet pipe.

[Bd. of Health, Indiv. Sewage Disposal Systems Reg. §§ 12.6.14-12.6.14.2, eff. 11-23-72]—(NAC A by R129-98, 3-25-99)

NAC 444.815 Plumbing accessory structure into system serving single-family dwelling. ([NRS 439.200](#), [444.650](#))

1. An accessory structure may be allowed to plumb into an individual sewage disposal system that serves a single-family dwelling if:

(a) The accessory structure is used in conjunction with the single-family dwelling; and

(b) The septic tank has sufficient capacity to accommodate the total number of fixtures in the accessory structure and the single-family dwelling, as determined by the following table:

--	--

TYPE OF FIXTURE	FIXTURE UNITS
Bathtub	2
Bidet	2
Drinking fountain	1
Floor drain	2
Interceptor:	
For items such as grease, oil or solids	3
Laundry tub	2
Machine for washing clothes	2
Sewer connection for a recreational vehicle	6
Shower, single stall	2
Sink:	
Bar, private (1 1/2-inch or 38.1-millimeter minimum waste)	1
Bathroom (single)	1
Bathroom (double)	2
Kitchen, with or without dishwasher (2-inch or 50.8-millimeter minimum waste)	2
Service	3
Toilet	6
Urinal	2

2. For the purposes of this section, each fixture unit must be rated at 25 gallons.
(Added to NAC by Bd. of Health by R100-07, eff. 10-31-2007)

NAC 444.818 Limitations and site requirements. ([NRS 439.200](#), [444.650](#))

1. Cesspools are prohibited.
2. The discharge of surface, rain and other clear water into an individual sewage disposal system is prohibited.
3. An absorption system that must be specially designed because of the limiting characteristics of the site must be designed by an engineer in accordance with the design criteria:
 - (a) That are set forth in [NAC 444.8374](#) to [444.8396](#), inclusive, if the absorption system is an alternative absorption system; or
 - (b) That have been approved by the health authority.
4. An individual sewage disposal system is prohibited in any area subject to vehicular traffic or any area to be paved.
5. Sewage or any waste must not be discharged into any well, deep pit or mine shaft, or onto the ground surface.
6. Approved plans and specifications must not be revised except with written approval of the administrative authority.
7. If the soil has a fast percolation rate, the administrative authority may, depending on the characteristics of the soil and site, require:
 - (a) The plans for the system be designed especially for the site; and
 - (b) The setbacks from wells or watercourses, or both, be increased.
8. An individual sewage disposal system must be operated and maintained so as not to create a public hazard or nuisance, or cause water pollution.
9. A septic tank that is no longer in use may be pumped, removed and disposed of. A septic tank that is no longer in use and is to be abandoned in place must be filled with dirt or sand after being pumped. An excavation site created by the removal of a septic tank must be backfilled with suitable material that is

compatible to the intended future use of the site.

10. To facilitate cleaning and maintenance operations, the installer of an individual sewage disposal system shall provide the owner with a diagram of the system. The diagram must include the location of the house, the septic tank, the cleanouts and the absorption system. This information must be kept on the premises regardless of changes in occupancy.

11. Any necessary bends in the individual sewage disposal system before the system enters the septic tank must be accomplished by the use of pipe fittings that are 45 degrees or less.

12. Every dwelling or habitation, including occupied trailers, must have an approved method of sewage disposal. The health authority may issue a permit for the temporary use of a holding tank at locations, including labor camps for construction or drilling projects, where an approved method of sewage disposal is not available. An application for a permit for the temporary use of a holding tank must include a copy of:

(a) A contract between the applicant and a licensed septic tank pumping contractor that provides for the removal and disposal of wastes from the temporary tank; and

(b) A letter from an approved sewage disposal treatment facility stating that the facility agrees to accept the wastes from the holding tank collected by the septic tank pumping contractor.

È A permit for the temporary use of a holding tank issued pursuant to this subsection is valid for 30 days and may be renewed as necessary.

13. The disposal of sewage must be through an approved individual sewage disposal system.

14. Provisions not covered by [NAC 444.750](#) to [444.8396](#), inclusive, must meet the most restrictive requirements found in the current publication of the *Uniform Plumbing Code*, adopted by reference pursuant to [NAC 444.7825](#).

15. Disposal fields must be located in unshaded, unobstructed areas.

16. Where a public water supply is unavailable, only one single-family dwelling per acre served by an individual sewage disposal system is allowed. For the purposes of this subsection, obtaining the approval of the Division of Water Resources of the State Department of Conservation and Natural Resources to use a well as municipal or quasi-municipal water use does not constitute a “public water supply.” The administrative authority shall not allow any additional individual sewage disposal systems to be installed on the lot.

[Bd. of Health, Indiv. Sewage Disposal Systems Reg. Note & unmarked paragraph, eff. 1962; A and renumbered as §§ 15.3 & 15.12, 11-23-72; renumbered as §§ 15.1, 15.2, 15.4-15.11, 15.13-15.17, 11-23-72] —(NAC A 10-22-93; R129-98, 3-25-99; R100-07, 10-31-2007)

Septic Tank Pumping Contractors

NAC 444.820 General requirements for and restrictions on operation. ([NRS 439.200](#), [444.650](#))

1. A person shall not engage in the operation of removing and disposing of the solid and liquid contents of septic tanks, holding tanks, grease traps, grease interceptors, portable toilets or other sewage treatment or disposal facilities unless the person has obtained an annual permit from the health authority. To obtain a permit pursuant to this section and [NAC 444.821](#), [444.822](#) and [444.828](#), the applicant must file with the health authority an application on a form prescribed, prepared and furnished by the health authority. A written application must be filed annually and as necessary to amend the permit. A permit must be amended before using a vehicle which is not listed on the application and before changing a point of discharge.

2. The application for this permit must contain the following information:

(a) The area to be served.

(b) The type of waste to be hauled.

(c) The exact location of all discharge sites and type of waste to be discharged at each location. The application must include a letter from the operating authority of each such discharge site which states that the operating authority will accept the waste to be removed and disposed of by the applicant at the discharge site.

(d) The license number, vehicle identification number, make, model, year and color of each vehicle which the holder of a permit intends to use to remove or dispose of solid and liquid contents of septic tanks, holding tanks, grease traps, grease interceptors, portable toilets or other sewage treatment or disposal facilities. If the color of the vehicle is changed, the applicant or the holder of the permit, as appropriate, shall forthwith notify the health authority in writing of the change.

(e) The capacity of each vehicle to be listed on the permit.

(f) The location where each vehicle will be stored.

(g) The names and addresses of the employees of the applicant who will be removing or disposing of solid and liquid contents of septic tanks, holding tanks, grease traps, grease interceptors, portable toilets or other sewage treatment or disposal facilities. Not later than 2 weeks after the date on which any change in personnel is made, the applicant or holder of a permit, as appropriate, shall submit written notification of the change to the health authority.

(h) A description of each tank which is not physically affixed to a vehicle and which will be used to remove, dispose of or store solid and liquid contents of septic tanks, holding tanks, grease traps, grease interceptors, portable toilets or other sewage treatment or disposal facilities. The description must include the dimensions, size, capacity and color of each tank.

(i) A statement signed by the applicant that all waste material collected will be disposed of in accordance with the provisions of [NAC 444.750](#) to [444.8396](#), inclusive, and that such waste will not be discharged to any waterway or sewer nor deposited on any land, including privately owned land, without the prior approval of the health authority or the Division of Environmental Protection of the State Department of Conservation and Natural Resources, as appropriate.

(j) Evidence satisfactory to the health authority that the applicant is of reputable and responsible character. If the applicant is a firm, association, organization, partnership, business trust, corporation or company, similar evidence must be submitted as to the members thereof and the person in charge of the business for which the application is made.

(k) A copy of the vehicle registration issued by the Department of Motor Vehicles for each vehicle to be used by the septic tank pumping contractor to remove and dispose of the solid and liquid contents of septic tanks, holding tanks, grease traps, grease interceptors, portable toilets or other sewage treatment or disposal facilities. Upon the request of the health authority, an applicant shall include in an application the original or a certified copy of the state registration or bill of sale, or both, for each vehicle listed on the application. If, while an application is pending, the ownership of a vehicle listed on the application changes, the applicant shall forthwith provide the health authority with documentation of the change. If a change in the ownership of the vehicle changes after a permit has been issued, the holder of the permit shall, not later than 2 weeks after the date on which the change occurred, provide to the health authority documentation of the change. If the applicant is not the registered owner of a vehicle, the applicant shall submit documentation of his or her authority to use the vehicle.

(l) Such other information as may be required by the health authority.

3. If a septic tank pumping contractor uses:

(a) A tank which is not physically attached to a vehicle, the name, phone number and permit number of the septic tank pumping contractor must be legibly and permanently lettered on:

(1) The tank; and

(2) Any vehicle used to transport the tank.

(b) A tank that is mounted on a vehicle used for septic tank pumping purposes, the name, phone number and permit number of the septic tank pumping contractor must be legibly and permanently lettered on both sides and the rear of:

(1) The tank; or

(2) The vehicle on which the tank is mounted.

Ê Unless otherwise authorized by the Health Division pursuant to subsection 4, the lettering required pursuant to this subsection must be at least 4 inches in height and of a color that contrasts with the color of the tank or vehicle, as appropriate.

4. A septic tank pumping contractor may submit a written request to the Health Division to use lettering that is smaller than the size of the lettering required pursuant to subsection 3. The request must include the size of the lettering requested and the reasons for the smaller lettering. The Health Division may approve a request for smaller lettering if the size or design of the vehicle or tank will not accommodate lettering at least 4 inches in height. The Health Division shall approve or deny a request for smaller lettering and notify the septic tank pumping contractor of its decision in writing within 30 days after receipt of a written request for smaller lettering. If the Health Division approves a request for smaller lettering on a vehicle used to transport a tank which is not physically attached to the vehicle, a vehicle used for septic tank pumping purposes or on a

tank mounted on a vehicle used for septic tank pumping purposes, the septic tank pumping contractor must keep the written approval of the Health Division, or a legible copy thereof, in the vehicle for which it is issued. If the Health Division approves a request for smaller lettering for a tank which is not physically attached to a vehicle, the septic tank pumping contractor must carry the written approval of the Health Division, or a legible copy thereof, with the tank. The septic tank pumping contractor shall, upon demand, make available the written approval of the Health Division for smaller lettering, or the copy thereof, to the staff of the Health Division for examination.

5. Each tank and portable receptacle that is used to transport liquid or solid waste must have the words "SEWAGE SLUDGE" or "RAW SEWAGE" permanently and legibly labeled on both sides of the tank or portable receptacle and on the rear of the tank or portable receptacle. The lettering must be at least 4 inches in height and of a color that contrasts with the color of the tank or portable receptacle, as appropriate.

6. Every vehicle used for septic tank pumping purposes must be equipped with a watertight tank. A tank and portable receptacle that is used to transport liquid or solid waste must be maintained in a clean and sanitary condition. Water that is used to clean a portable receptacle must be disposed of in an approved individual sewage disposal system or sewage treatment facility. Liquid or solid waste must not be transported in a vehicle with an open body unless the waste is contained within suitable portable receptacles. All pumps and hose lines must be maintained so as to prevent leakage.

7. Prior approval in writing must be obtained from the health authority and the operating authority of the discharge site for every location at which a septic tank pumping contractor plans to discharge a specific volume of waste material collected. No waste material may be discharged on any site without prior approval. Waste material collected by the septic tank pumping contractor must not be discharged into ditches, watercourses, lakes, ponds or any point where it can pollute any watercourse, water supply source or bathing area. Waste material must not be deposited within 600 feet of any highway or residence.

8. A vehicle or portable receptacle that is used to remove or dispose of solid or liquid wastes must not be used for any other purpose.

9. The health authority may deny an application for a permit if the applicant:

(a) Engaged in the operation of removing and disposing of solid and liquid contents of septic tanks, holding tanks, grease traps, grease interceptors or other sewage treatment or disposal facilities before obtaining a permit from the health authority.

(b) Failed to comply with the provisions of this section and [NAC 444.821](#), [444.822](#) and [444.828](#).

10. The health authority may refuse to renew a permit or may suspend or revoke a permit if the holder of a permit:

(a) Violates any provision of this chapter or [chapter 444](#) of NRS;

(b) Violates any of the terms of the permit; or

(c) Uses a vehicle or tank which is not listed in the permit.

[Bd. of Health, Indiv. Sewage Disposal Systems Reg. §§ 16.1-16.7, eff. 11-23-72]—(NAC A 10-30-97; R129-98, 3-25-99; R193-03, 1-22-2004)

NAC 444.821 Permit: Contents; validity and transferability. ([NRS 439.200](#), [444.650](#))

1. A permit issued by the health authority to a septic tank pumping contractor must contain:

(a) The name, business address and mailing address of the person to whom the permit is issued; and

(b) The number of the license plate of each vehicle and the number of tanks that are authorized for use by the septic tank pumping contractor to remove and dispose of the solid and liquid contents of septic tanks, holding tanks, grease traps, grease interceptors, portable toilets, or other sewage treatment or disposal facilities. The vehicles and tanks listed on the permit must be specifically identified in the application for the permit filed pursuant to [NAC 444.820](#).

2. A permit is valid only for the person to whom it is issued, and for the vehicles and tanks described in the application and listed on the permit. A permit is not transferable.

(Added to NAC by Bd. of Health by R129-98, eff. 3-25-99)

NAC 444.822 Permit: Conditions that require amendment. ([NRS 439.200](#), [444.650](#)) A holder of a permit to operate as a septic tank pumping contractor must amend the permit pursuant to [NAC 444.820](#) before he or she may:

1. Use a vehicle or tank which is not listed on the permit to remove and dispose of the solid and liquid contents of septic tanks, holding tanks, grease traps, grease interceptors, portable toilets, or other sewage treatment or disposal facilities; or
2. Discharge solid or liquid waste at a location which was not listed on the application for the permit.
(Added to NAC by Bd. of Health by R129-98, eff. 3-25-99)

NAC 444.823 Permit: Renewal. ([NRS 439.200](#), [444.650](#)) A permit to operate as a septic tank pumping contractor is valid for 1 year after the date of issuance. To renew a permit, the holder of the permit must submit a completed application for renewal to the health authority not less than 45 days before the date on which the permit expires. The health authority may require an inspection of the vehicles and tanks to be listed on the permit to ensure that the vehicles and tanks comply with the requirements of [NAC 444.750](#) to [444.8396](#), inclusive. The health authority shall not schedule such an inspection until after the health authority has received a completed application and the appropriate fees from the applicant for the renewal of the permit.

(Added to NAC by Bd. of Health by R129-98, eff. 3-25-99)

NAC 444.824 Recordkeeping requirements. ([NRS 439.200](#), [444.650](#))

1. A septic tank pumping contractor shall keep a record of each removal and disposal of solid or liquid waste by the septic tank pumping contractor. The record must include:
 - (a) The type of solid or liquid waste that was removed;
 - (b) The number of the license plate of the vehicle that removed the waste;
 - (c) The name of the employee who removed the waste;
 - (d) The date, time and location of the removal of the waste;
 - (e) The date, time and location of the disposal of the waste; and
 - (f) If the waste was disposed of at a waste disposal site, a receipt from the operating authority of the waste disposal site.
2. The septic tank pumping contractor shall keep a record of each cleaning by the septic tank pumping contractor of the interior of the portable receptacle or the tank of a vehicle that is used to remove or dispose of solid or liquid waste. The record must include:
 - (a) The name of the employee who cleaned the portable receptacle or tank; and
 - (b) The date, time and location of the cleaning of the portable receptacle or tank.
3. The septic tank pumping contractor shall, in each vehicle used by the septic tank pumping contractor to remove or dispose of solid or liquid waste, keep daily records of:
 - (a) The removal and disposal of solid or liquid waste by the vehicle; and
 - (b) The interior cleaning of the portable receptacle or the tank of the vehicle.
4. On or after the last day of the month in which the daily records required by subsection 3 were made, the septic tank pumping contractor may transfer the daily records from the vehicle to the location where the other records required by this section are retained.
5. A septic tank pumping contractor shall retain the records required by this section for at least 3 years after the date on which the solid or liquid waste was removed and disposed of or on which the interior of the portable receptacle or the tank was cleaned, as appropriate.
6. Upon the request of the health authority, the septic tank pumping contractor shall make the records required by this section available to the health authority.
(Added to NAC by Bd. of Health by R129-98, eff. 3-25-99)

Nonsewered Toilets

NAC 444.825 Toilet facilities for special events. ([NRS 439.200](#), [444.650](#))

1. The operator of a special event shall provide toilet facilities at the special event for:
 - (a) Persons who are working at the special event; and
 - (b) Patrons attending the special event.
2. Toilet facilities that are provided for a special event may include nonsewered toilets.
3. Toilet facilities that are provided for a special event must be kept clean and in good repair. An

adequate supply of toilet tissue must be provided for each toilet at all times.

4. The operator of a special event shall provide facilities for the washing of hands for persons who prepare food at the special event.

5. The operator of a special event shall determine the number of toilet facilities required for the special event based on the following table:

NUMBER OF TOILET FACILITIES REQUIRED										
EXPECTED PEAK HOURLY ATTENDANCE AT THE EVENT	EXPECTED AVERAGE NUMBER OF HOURS SPENT AT THE EVENT PER PERSON									
	0-1	2	3	4	5	6	7	8	9	10 or more
1-500	2	4	4	5	6	7	9	9	10	12
501-1,000	4	6	8	8	9	9	11	12	13	13
1,001-2,000	5	6	9	12	14	16	18	20	23	25
2,001-3,000	6	9	12	16	20	24	26	30	34	38
3,001-4,000	8	13	16	22	25	30	35	40	45	50
4,001-5,000	12	15	20	25	31	38	44	50	56	63
5,001-10,000	15	25	38	50	63	75	88	100	113	125
10,001-15,000	20	38	56	75	94	113	131	150	169	188
15,001-20,000	25	50	75	100	125	150	175	200	225	250

6. Upon the request of the operator of a special event, the health authority shall review the number of toilet facilities to be provided for the special event to determine whether the number of toilet facilities that will be provided for the special event is sufficient.

(Added to NAC by Bd. of Health by R129-98, eff. 3-25-99)

NAC 444.826 General requirements. ([NRS 439.200](#), [444.650](#))

1. Before a person may operate a service to provide nonsewered toilets, the person must obtain a permit pursuant to this section and [NAC 444.820](#) and [444.828](#). A nonsewered toilet must not be used for the permanent disposal of sewage.

2. The health authority may, at any time, inspect the area in which the nonsewered toilets are stored and cleaned to ensure that the requirements relating to cleaning and disposal are met.

3. The person operating a service to provide nonsewered toilets shall provide an area suitable for the storage and maintenance of all equipment utilized in the operation. The area must be maintained in a neat and clean condition at all times.

4. If a nonsewered toilet is removed from service, the toilet must be thoroughly cleaned by steam, pressurized hot water or other means approved by the health authority before the toilet may be placed back

into service. Water that is used to clean a nonsewered toilet must be disposed of in an approved sewage disposal system or sewage treatment facility.

5. The holding tank of a nonsewered toilet must be empty of all material while the toilet is being transported unless the toilet is designed to transport material in its holding tank and is permanently affixed to a trailer or other mobile structure.

6. A nonsewered toilet must be constructed of smooth, durable, nonabsorbent material which is easy to clean. The interior of the nonsewered toilet must be light in color and capable of withstanding repeated cleaning.

7. A nonsewered toilet must be designed to prevent the entry of rodents and insects. All vent and window openings to the outside must be covered with metal or plastic mosquito screening. The door must be self-closing. A vent or window must be provided for light.

8. The holding tank for a nonsewered toilet must be:

- (a) Enclosed within the structure of the nonsewered toilet;
- (b) Properly vented;
- (c) Watertight;
- (d) Maintained in good repair; and
- (e) Accessible for cleaning and maintenance.

9. The toilet seat of a nonsewered toilet must be:

- (a) Made of a smooth, impervious material; and
- (b) Installed so that it can be easily cleaned or replaced.

10. While a nonsewered toilet is in service, the interior of the toilet must be cleaned at least once every 7 days and more often as needed to maintain the toilet in a clean and odor-free condition.

11. An adequate supply of toilet paper must be provided for a nonsewered toilet at all times when the toilet is in service.

12. A structure for a nonsewered toilet must be clearly and legibly marked with the name and telephone number of the operator of the service that provided the toilet.

13. The health authority may exempt a nonsewered toilet that is especially designed for use in a high-rise construction project from any provision of this section.

(Added to NAC by Bd. of Health by R129-98, eff. 3-25-99)

Fees

NAC 444.828 Schedule of fees. ([NRS 439.150](#), [439.200](#), [444.650](#)) The Health Division shall charge and collect fees for its services in accordance with the following schedule, except in areas where the laws and regulations governing individual sewage disposal systems and septic tank pumping contractors are administered by another administrative authority:

1. For a permit to construct an individual sewage disposal system for a single-family dwelling, including a review of the plan for the system and an initial inspection of the system.....	\$498
2. For a permit to construct a residential system that utilizes an alternative treatment or disposal system design, including a review of the plan for the system and an initial inspection of the system.....	\$498
3. For a review of the plan for a primary treatment unit.....	\$498
4. For the resubmission of or revision to a plan described in subsection 1, 2 or 3.....	\$124
5. For a reinspection of an individual sewage disposal system.....	\$100
6. For an inspection of a system or unit described in subsection 1, 2 or 3 where such inspection is necessary to obtain a loan to purchase a piece of real property.....	\$133
7. For an annual permit for a septic tank pumping contractor.....	\$332

Plus \$322 per year for each pumping unit to be authorized for use pursuant to the permit.

8. To extend a permit to construct an individual sewage disposal system for a 1-year period after the expiration date of the permit..... \$332

(Added to NAC by Bd. of Health, eff. 7-20-82; A 7-22-87; 8-31-89; R129-98, 3-25-99; R193-03, 1-22-2004; R100-07, 10-31-2007)

Discharge and Treatment of Liquid Waste and Wastewater

NAC 444.8301 General requirements for primary treatment unit; use of alternative treatment system. (NRS 439.200, 444.650)

1. All liquid waste and wastewater must be discharged into a septic tank or other approved primary treatment unit. Graywater may be discharged separately in accordance with [NAC 444.837](#) and [444.8372](#). Water from a roof or footing, water from garage and surface drainage, and processed water must be prevented from entering an individual sewage disposal system.

2. A primary treatment unit must be of sufficient size to provide adequate treatment during a period of maximum inflow.

3. A primary treatment unit must be accessible. If the top of the primary treatment unit is more than 18 inches below the surface of the ground, a manhole extension that is at least 24 inches in diameter and extends from the top of the unit to within 18 inches of the surface of the ground must be used for each access into the unit.

4. To prevent differential settling, a primary treatment unit must be placed on undisturbed soil, or on at least 4 inches of sand overlying a firm and uniform base.

5. An alternative treatment system, other than those described in [NAC 444.8314](#) to [444.8324](#), inclusive, may be used if approved by the health authority. An alternative treatment system must have a minimum capacity that is equal to the required minimum capacity of the appropriate septic tank as calculated pursuant to [NAC 444.8304](#) and [444.8306](#).

(Added to NAC by Bd. of Health by R129-98, eff. 3-25-99)

NAC 444.8302 Plans for commercial systems to be submitted for review. (NRS 439.200, 444.650) The plans for a commercial system must be submitted for review to the Division of Environmental Protection of the State Department of Conservation and Natural Resources.

(Added to NAC by Bd. of Health by R129-98, eff. 3-25-99; A by R100-07, 10-31-2007)

NAC 444.8304 General requirements for septic tank used as primary treatment unit or with alternative treatment system. (NRS 439.200, 444.650) A septic tank that is used as a primary treatment unit or in conjunction with an alternative treatment system must meet the requirements of [NAC 444.804](#) to [444.810](#), inclusive.

(Added to NAC by Bd. of Health by R129-98, eff. 3-25-99)

NAC 444.8306 Capacity of septic tank serving single-family dwelling. (NRS 439.200, 444.650)

1. The minimum capacity for a septic tank that serves a single-family dwelling is based on the number of bedrooms in the dwelling, and is determined as follows:

Number of Bedrooms	Minimum Liquid Capacity of Tank (in Gallons)
3 or less	1,000
4	1,200
5 or 6	1,500

If the single-family dwelling has more than six bedrooms, 150 gallons for each additional bedroom must be

added to 1,500 gallons.

2. An absorption system designed for a septic tank may be based on the minimum required size for the septic tank.

(Added to NAC by Bd. of Health by R129-98, eff. 3-25-99)

NAC 444.8314 Aerobic wastewater treatment unit: Maintenance; repair or replacement; required use. ([NRS 439.200](#), [444.650](#))

1. An aerobic wastewater treatment unit requires routine maintenance. The owner of an individual sewage disposal system that will include an aerobic wastewater treatment unit shall include in the design plans submitted to the administrative authority a maintenance agreement with an approved service provider that covers the anticipated life span of the individual sewage disposal system.

2. The maintenance agreement for the individual sewage disposal system must include, without limitation, a yearly inspection of the system, and the components thereof, which verifies that the system is:

(a) Functioning correctly; and

(b) Producing effluent which has levels of total suspended solids and biological oxygen demand that are each 30 milligrams or less per liter.

3. At the request of the administrative authority, the owner of an individual sewage disposal system that includes an aerobic wastewater treatment unit must provide to the administrative authority written documentation demonstrating that the maintenance required by subsection 2 has been performed.

4. An aerobic wastewater treatment unit that produces effluent with a level of total suspended solids or biological oxygen demand that is more than 30 milligrams per liter must be repaired or replaced in accordance with this section and [NAC 444.8316](#) and [444.8318](#) before the unit may be used.

5. If the administrative authority determines that the degradation of groundwater or the constraints of the site warrant the need for an effluent which is of higher quality than that which would be provided by a septic tank, the administrative authority may require that the individual sewage disposal system include an aerobic wastewater treatment unit. If the administrative authority requires the use of an aerobic wastewater treatment unit pursuant to this subsection, the owner shall not construct or install on that site an individual sewage disposal system that does not include an aerobic wastewater treatment unit.

(Added to NAC by Bd. of Health by R129-98, eff. 3-25-99; A by R100-07, 10-31-2007)

NAC 444.8316 Aerobic wastewater treatment unit: Approval required; design criteria; limitations on use; manual of operation and maintenance. ([NRS 439.200](#), [444.650](#))

1. An aerobic wastewater treatment unit must be approved by:

(a) NSF International pursuant to its Standard 40;

(b) Any other equivalent nationally recognized testing laboratory approved by the health authority; or

(c) The health authority.

2. An application to construct an individual sewage disposal system that includes an aerobic wastewater treatment unit must include evidence that the unit has been approved pursuant to subsection 1.

3. An individual sewage disposal system that uses an aerobic wastewater treatment unit must be designed by an engineer. The use of an individual sewage disposal system that includes an aerobic wastewater treatment unit must be consistent with the approved design application and intended use for such a system.

4. An aerobic wastewater treatment unit must conform with all applicable provisions of the Nevada Administrative Code and is subject to any other requirements for design that are determined necessary by the administrative authority.

5. An administrative authority may authorize a reduction in the size of the absorption area if the administrative authority requires the use of an aerobic wastewater treatment unit pursuant to subsection 5 of [NAC 444.8314](#). Any reduction in the size of the absorption area must be justified by an engineer based on the conditions of the soil and constraints of the site. No direct surface discharge is permitted.

6. Except in those cases where an aerobic wastewater treatment unit is required pursuant to subsection 5 of [NAC 444.8314](#), an aerobic wastewater treatment unit must not be used where electrical service is unreliable, dependable maintenance is not available, or intermittent use of the aerobic wastewater treatment unit will adversely effect the functioning of the individual sewage disposal system.

7. The design plans for an aerobic wastewater treatment unit must include a schematic detailing a 24-hour operating alarm system for the aerobic wastewater treatment unit.

8. A manual for the operation and maintenance of an aerobic wastewater treatment unit must be submitted to the administrative authority with the design plans. The administrative authority shall not approve an aerobic wastewater treatment unit if an operation and maintenance manual has not been submitted with the design plans and approved by the administrative authority.

(Added to NAC by Bd. of Health by R129-98, eff. 3-25-99; A by R100-07, 10-31-2007)

REVISER'S NOTE.

The regulation of the State Board of Health filed with the Secretary of State on March 25, 1999 (LCB File No. R129-98), the source of this section (section 60 of the regulation), contains the following provision not included in NAC:

"Sec. 116. The amendatory provisions of section 60 of this regulation [[NAC 444.8316](#)] apply only to aerobic wastewater treatment units that are constructed or repaired on or after the effective date of this regulation [March 25, 1999]."

NAC 444.8318 Aerobic wastewater treatment unit: Inspection. ([NRS 439.200](#), [444.650](#))

1. The construction of an aerobic wastewater treatment unit must be inspected and verified by an engineer. The inspections must be conducted when:

(a) The absorption trenches have been excavated or, if an elevated mound system is to be used, when the basal area of the mound has been scarified;

(b) The distribution piping has been placed in the aggregate;

(c) The system has been covered with soil; and

(d) All the pumps, switches, alarms, aeration units and other components associated with the individual sewage disposal system have been installed. The engineer or homeowner, as appropriate, shall verify that the operational liquid levels are set as specified by the design plans.

2. The engineer shall, within 30 days after the date on which the construction of the system is completed, submit a letter to the administrative authority stating that the system was constructed in accordance with the approved plans.

(Added to NAC by Bd. of Health by R129-98, eff. 3-25-99; A by R100-07, 10-31-2007)

NAC 444.8321 Nitrogen removal wastewater treatment unit: Maintenance; repair or replacement; required use; regulatory oversight program. ([NRS 439.200](#), [444.650](#))

1. A nitrogen removal wastewater treatment unit requires routine maintenance. The owner of an individual sewage disposal system that will include a nitrogen removal wastewater treatment unit shall include in the design plans submitted to the administrative authority a maintenance agreement with an approved service provider that covers the anticipated life span of the individual sewage disposal system.

2. The maintenance agreement for the individual sewage disposal system must include, without limitation, a yearly inspection of the system, and the components thereof, which verifies that the system is:

(a) Functioning correctly; and

(b) Producing effluent with nitrogen level reductions that are consistent with the performance specifications provided by the manufacturer.

3. The owner of an individual sewage disposal system that includes a nitrogen removal wastewater treatment unit shall maintain, for the life of the system, written documentation demonstrating that the maintenance required by subsection 2 has been performed at intervals not to exceed 12 months. At the request of the administrative authority, the owner shall provide the documentation for review.

4. A nitrogen removal wastewater treatment unit that produces effluent with nitrogen level reductions that are not consistent with the performance specifications provided by the manufacturer must be repaired or replaced in accordance with this section and [NAC 444.8322](#) and [444.8324](#).

5. If the administrative authority determines that the degradation of groundwater or the constraints of the site warrant the need for an effluent which is of higher quality than that which would be provided by a septic tank, the administrative authority may require that the individual sewage disposal system include a nitrogen removal wastewater treatment unit. If the administrative authority requires the use of a nitrogen removal wastewater treatment unit pursuant to this subsection, the owner shall not construct or install on that site an individual sewage disposal system that does not include a nitrogen removal wastewater treatment unit.

6. The approved service provider shall develop and submit to the health and administrative authorities a

regulatory oversight program for the use of nitrogen removal wastewater treatment units. The regulatory oversight program must include, without limitation, the legal description of each lot to be included in the program, the type and frequency of maintenance to be conducted, requirements for reporting maintenance that is conducted and provisions for addressing noncompliance with the provisions of this chapter by occupants of a building served by a nitrogen removal wastewater treatment unit. Until both the health and administrative authorities approve the regulatory oversight program in writing, the administrative authority shall not approve nitrogen removal wastewater treatment units for use.

(Added to NAC by Bd. of Health by R129-98, eff. 3-25-99; A by R100-07, 10-31-2007)

NAC 444.8322 Nitrogen removal wastewater treatment unit: Approval required; design criteria; limitations on use; manual of operation and maintenance. ([NRS 439.200](#), [444.650](#))

1. A nitrogen removal wastewater treatment unit must be approved by:
 - (a) NSF International pursuant to its Standard 40;
 - (b) Any other equivalent nationally recognized testing laboratory approved by the health authority; or
 - (c) The health authority.
2. An application to construct an individual sewage disposal system that includes a nitrogen removal wastewater treatment unit must include evidence that the unit has been approved pursuant to subsection 1.
3. An individual sewage disposal system that uses a nitrogen removal wastewater treatment unit must be designed by an engineer. The use of an individual sewage disposal system that includes a nitrogen removal wastewater treatment unit must be consistent with the approved design application and intended use for such a system.
4. A nitrogen removal wastewater treatment unit must conform with all applicable provisions of the Nevada Administrative Code and is subject to any other requirements for design that are determined necessary by the administrative authority.
5. An administrative authority may authorize a reduction in the size of the absorption area if the administrative authority requires the use of a nitrogen removal wastewater treatment unit pursuant to subsection 5 of [NAC 444.8321](#). Any reduction in the size of the absorption area must be justified by an engineer based on the conditions of the soil and constraints of the site. No direct surface discharge is permitted.
6. Except in those cases where a nitrogen removal wastewater treatment unit is required pursuant to subsection 5 of [NAC 444.8321](#), a nitrogen removal wastewater treatment unit must not be used where:
 - (a) The unit requires electrical power and the electrical service is unreliable;
 - (b) Dependable maintenance is not available; or
 - (c) The building will be occupied on a part-time basis and intermittent use of the nitrogen removal wastewater treatment unit will adversely effect the functioning of the individual sewage disposal system.
7. The design plans for a nitrogen removal wastewater treatment unit must include a schematic detailing a 24-hour operating alarm system for the nitrogen removal wastewater treatment unit.
8. A manual for the operation and maintenance of a nitrogen removal wastewater treatment unit must be submitted to the administrative authority with the design plans. The administrative authority shall not approve a nitrogen removal wastewater treatment unit if an operation and maintenance manual has not been submitted with the design plans and approved by the administrative authority.

(Added to NAC by Bd. of Health by R129-98, eff. 3-25-99; A by R100-07, 10-31-2007)

REVISER'S NOTE.

The regulation of the State Board of Health filed with the Secretary of State on March 25, 1999 (LCB File No. R129-98), the source of this section (section 63 of this regulation), contains the following provision not included in NAC:

"Sec. 117. The amendatory provisions of section 63 of this regulation [[NAC 444.8322](#)] apply only to nitrate removal wastewater treatment units that are constructed or repaired on or after the effective date of this regulation [March 25, 1999]."

NAC 444.8324 Nitrogen removal wastewater treatment unit: Inspection. ([NRS 439.200](#), [444.650](#))

1. The construction of a nitrogen removal wastewater treatment unit must be inspected and verified by an engineer. The inspections must be conducted when:
 - (a) The absorption trenches have been excavated or, if an elevated mound system is to be used, when the basal area of the mound has been scarified;

- (b) The distribution piping has been placed in the aggregate;
- (c) The system has been covered with soil; and
- (d) All the pumps, switches, alarms, aeration units and other components associated with the individual sewage disposal system have been installed. The engineer or homeowner, as appropriate, shall verify that the operational liquid levels are set as specified by the design plans.

2. The engineer shall, within 30 days after the date on which the construction of the system is completed, submit a letter to the administrative authority stating that the system was constructed in accordance with the approved plans.

(Added to NAC by Bd. of Health by R129-98, eff. 3-25-99; A by R100-07, 10-31-2007)

NAC 444.8326 Dosing tank: General requirements. ([NRS 439.200](#), [444.650](#))

1. A dosing tank must be used if:

- (a) It is necessary to raise the elevation of the wastewater for further treatment or disposal of sewage;
- (b) Intermittent dosing of the disposal field is desired;
- (c) A pressure distribution system is used; or
- (d) More than 500 lineal feet of absorption trench are required for the individual sewage disposal system.

2. An individual sewage disposal system which proposes, or is required, to use a dosing tank must be designed by an engineer.

(Added to NAC by Bd. of Health by R129-98, eff. 3-25-99)

NAC 444.8328 Dosing tank: Design criteria. ([NRS 439.200](#), [444.650](#))

1. A dosing tank must have sufficient volume to provide for the volume desired for dosing and a reserve volume. The reserve volume, which is equal to the volume of the tank between the alarm switch for high levels of effluent and the bottom of the invert of the inlet pipe, must be of sufficient size to allow the owner of the system to respond to a high-level alarm before the level of effluent in the dosing tank reaches the invert of the inlet pipe.

2. If an electric pump is used in a dosing tank:

(a) The size of the pump must be determined according to the performance curves provided by the manufacturer, the flow rate needed and the size of the pumping head as calculated by an engineer. The engineer shall calculate the size of the pumping head by adding the difference in elevation between the highest elevation of the discharge pipe and the level for low effluent in the dosing chamber to the friction losses incurred in the discharge pipe. The engineer may make the calculations pursuant to this paragraph without considering velocity head.

(b) The control system for the dosing tank must include a switch to turn on the pump, a switch to turn off the pump and an alarm switch for high levels of effluent. The alarm switch must emit a visual and audible alarm and must be placed not less than 2 inches or more than 3 inches above the switch that turns off the pump to alert the owner that there is a high level of effluent or malfunction of the pump that will likely cause a high level of effluent. The alarm switch must be on a circuit that is separate from the circuit for the switches which turn the pump on and off. A switch used in a pumping chamber must be able to withstand the humid and corrosive atmosphere inside the tank. The owner shall include in the design plans an information sheet provided by the manufacturer for each pump, switch and alarm to be used in the dosing tank.

(c) All electrical contacts and relays must be mounted on the outside of the dosing tank to protect the contacts and relays from corrosion. The owner of the individual sewage disposal system shall take such actions as are necessary to prevent sewer gases from traveling through the electrical conduit into the control box.

3. The following is a diagram of a typical dosing tank with pump:

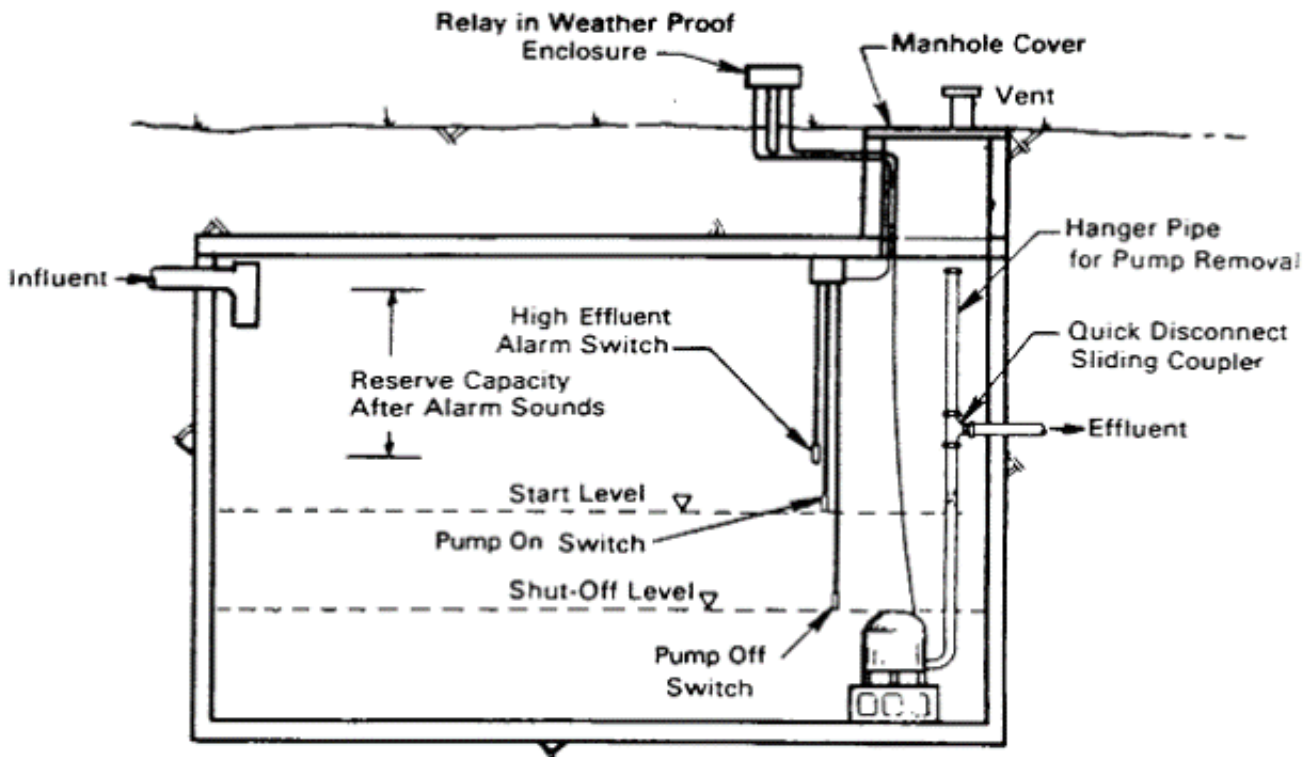

4. A siphon may be used in a dosing tank in lieu of an electric pump if the point of discharge is at a lower elevation than the elevation of the primary treatment unit. The size of the siphon must be determined by the average flow rate desired. The drawing depth, which is the distance from the bottom of the siphon bell to the high water level that is necessary to activate the siphon, must be determined by the manufacturer of the siphon. The volume of the dosing tank may be determined by adding the drawing depth to the length and width of the dosing tank. The following is a diagram of a typical dosing tank with a siphon:

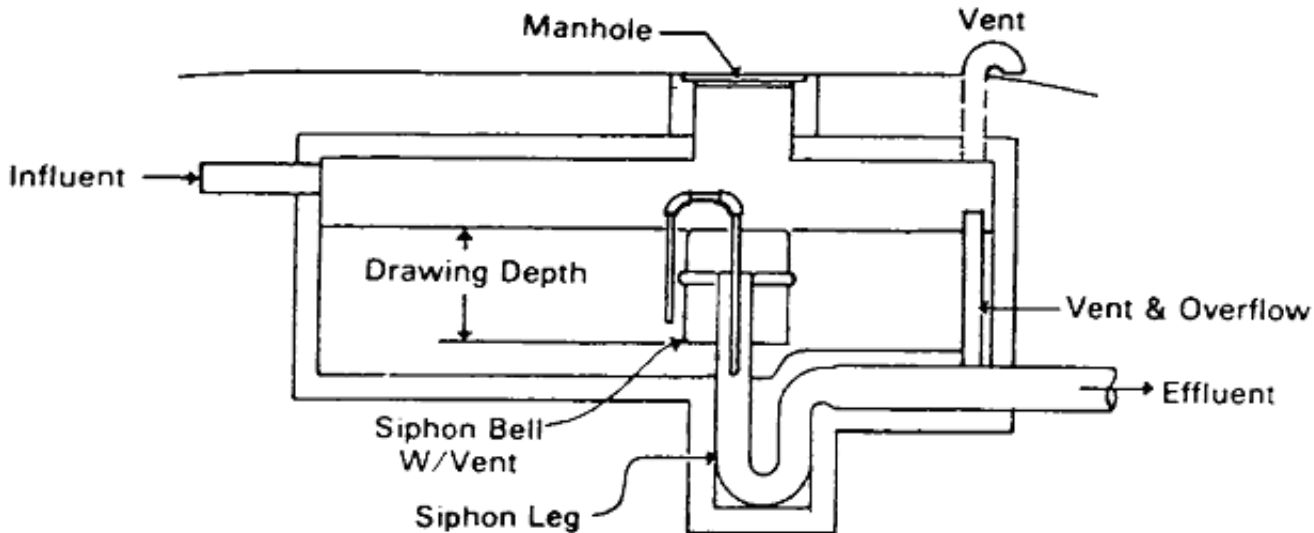

5. A dosing tank must be vented. The vent must be located as far away from the electrical control box as practical, but in no case may the vent be closer than 3 feet from the electrical control box.

6. The frequency of dosing varies depending on the texture of the soil at the interface of the sand and native soil at the base of the mound as follows:

SOIL TEXTURE	DOSING FREQUENCY
--------------	------------------

Sand	4 doses per day
Sandy Loam	1-2 doses per day
Silty Clay Loam	1 dose per day

7. The dosing volume must be of sufficient capacity to distribute effluent evenly to all parts of the distribution system. The dosing volume must be approximately 10 times the volume of the distribution piping in a pressure distribution system and not less than 60 percent or more than 75 percent of the volume of the distribution piping for a system which does not use a pressure distribution system.

(Added to NAC by Bd. of Health by R129-98, eff. 3-25-99)

NAC 444.833 Distribution box: General requirement; design criteria. ([NRS 439.200](#), [444.650](#))

1. Except where a pressure distribution system is used, a distribution box must be used in an absorption system if more than one distribution line is used.

2. A distribution box must be watertight and constructed of a durable material that is resistant to corrosion, including, without limitation, concrete, polyethylene, fiberglass or any other material approved by the health authority. The distribution box must have a cover that is made of the same material as the distribution box.

3. Each distribution line must be separately connected to the distribution box. The inverts of the outlet lines must be set at the same level above the bottom of the box. The inverts of the inlet must be at least 1 inch higher than the inverts of the outlet. A distribution box must be designed to ensure equal flow and must be installed on:

(a) Aggregate;

(b) A level concrete slab which is at least 6 inches in depth and which extends 6 inches or more beyond the perimeter of the distribution box; or

(c) Undisturbed soil.

4. The number of outlets of a distribution box must be equal to or greater than the number of distribution lines to be used.

5. The following is a diagram of a distribution box:

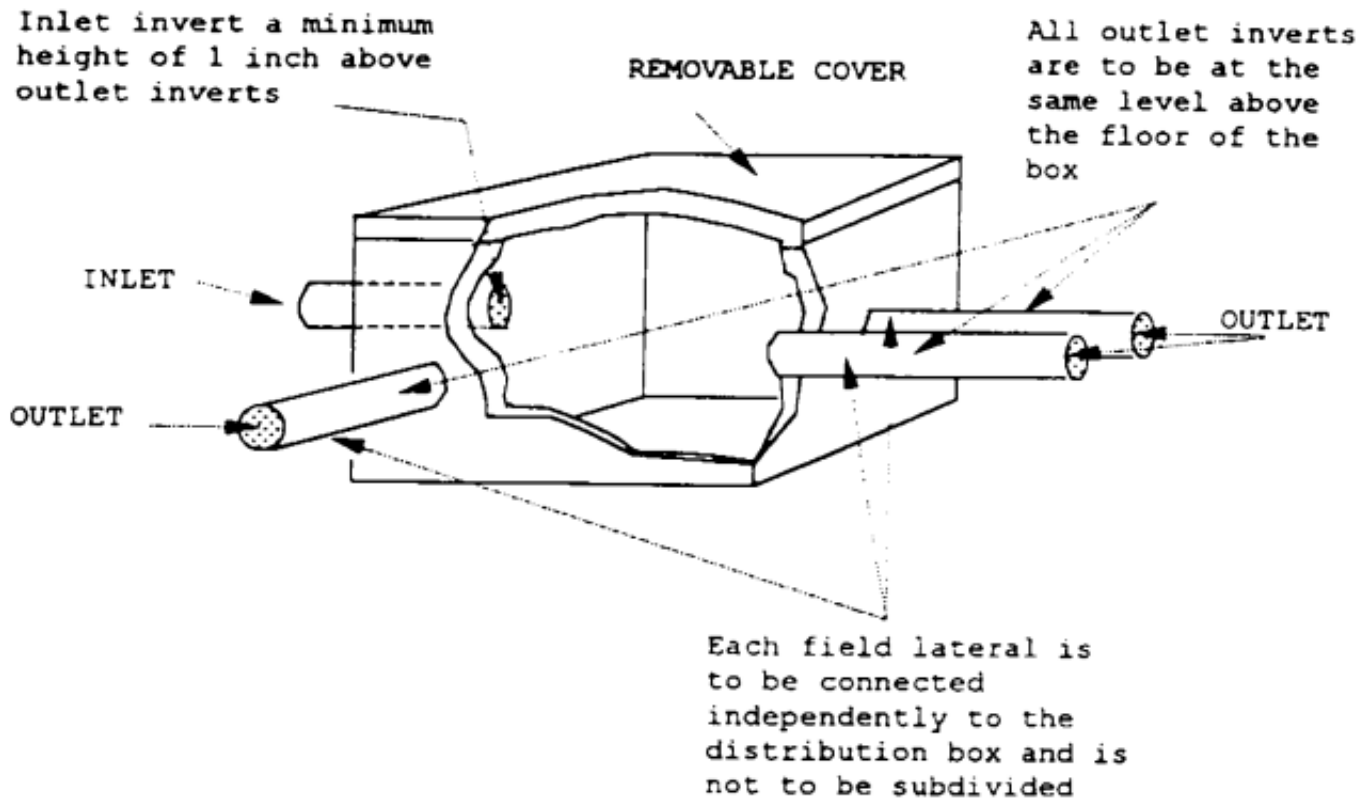

(Added to NAC by Bd. of Health by R129-98, eff. 3-25-99)

Absorption and Treatment of Effluent

NAC 444.835 Soil absorption system: General requirements. ([NRS 439.200](#), [444.650](#))

1. The effluent from a septic tank or other primary treatment unit must be disposed of through a soil absorption trench or through an absorption system approved by the administrative authority.

2. The size and type of the absorption area required for the disposal of the effluent must be determined according to the results of the percolation testing and the requirements for the sizing of the appropriate septic tank, except that if the percolation testing yields a percolation rate of less than 10 minutes per inch, the percolation rate shall be deemed to be 10 minutes per inch.

3. Soils to be used in a soil absorption trench must have a percolation rate that is 120 minutes per inch or less without interference from groundwater or impervious strata below the level of the absorption system. A test pit must be excavated and the profile of the soil to a minimum depth of 5 feet below the bottom of the proposed absorption system must be recorded in a log for the profile of the soil. Impervious barriers, bedrock, fractures, areas of open solution, clay, caliche or other limiting factors which may affect the effluent disposal area must be indicated in the log.

4. A soil absorption system intended for use on soils with percolation rates greater than 60 minutes per inch, or intended for commercial use, must be designed by an engineer.

5. The depth to the seasonal high groundwater, as observed as the surface of free water or as indicated by mottling or historical documentation, must be indicated in the log for the profile of the soil.

6. Unless otherwise approved by the administrative authority, the owner of the absorption system shall maintain at least 4 feet between the bottom of the disposal trench or absorption area and the level of seasonal high groundwater, impervious barriers or other limiting soil characteristics.

7. If the absorption trench will be placed in any soil which has a percolation rate of less than 2 minutes per inch, the administrative authority may, depending on the characteristics of the soil and site, require that:

- (a) The trench be specially designed by an engineer; and
- (b) The required setbacks from any well or watercourses be increased.

8. Effluent from a tank for the treatment of wastewater must be disposed of through a solid watertight

pipe that is at least 5 feet in length and placed immediately before the absorption system.

9. The tank for the treatment of wastewater and the soil absorption system must be separated by at least 5 feet, and the solid watertight pipe that connects the tank and the absorption system must be placed on undisturbed soil.

10. Distribution lines must be of equivalent length unless otherwise authorized by the administrative authority.

11. The slowest percolation rate generated by the percolation tests must be used to determine the required size of an absorption system.

12. An individual sewage disposal system must be designed to include a reserve absorption area which is equal in size to at least 100 percent of the primary required absorption area. The reserve absorption area must not be paved and is subject to the setback requirements for the primary absorption area. No vehicles may travel on the reserve absorption area.

(Added to NAC by Bd. of Health by R129-98, eff. 3-25-99)

NAC 444.8352 Absorption trench system: General requirements; design calculations. ([NRS 439.200](#), [444.650](#))

1. An individual sewage disposal system utilizing absorption trenches may be used wherever practical except if limiting conditions such as high groundwater, sloping terrain, impervious soil or bedrock exist at the site where the individual sewage disposal system is to be located.

2. The design for an individual sewage disposal system utilizing absorption trenches must comply with the design criteria set forth in this section and [NAC 444.8354](#) and [444.8356](#).

3. A homeowner or a licensed contractor may design a residential system that uses absorption trenches for the residence of the homeowner if the percolation rate of the soils in which the residential system will be placed is 60 minutes per inch or less and the site is free of the limiting conditions described in subsection 1.

4. The following is an example of the calculations required to design an individual sewage disposal system utilizing absorption trenches:

A homeowner plans to build a 4-bedroom house. Percolation testing yields percolation rates of 15 minutes per inch in test hole number one and 23 minutes per inch in test hole number two. To determine the required capacity of the wastewater treatment tank, the required number of square feet of disposal area, and the required number of lineal feet of absorption trench:

Step 1 – Pursuant to the table in subsection 1 of [NAC 444.8306](#), a septic or wastewater treatment tank that has a capacity of 1,200 gallons is required for a 4-bedroom house.

Step 2 – The slowest percolation rate, which is 23 minutes per inch, must be used to determine the design application rate. Pursuant to the table in subsection 9 of [NAC 444.8354](#), the design application rate is 1.0 gallon per square foot.

Step 3 – The required absorption area is calculated by dividing the capacity of the septic or wastewater treatment tank by the design application rate as follows:

$$1,200 \text{ gallons} \div 1.0 \text{ gallon/square foot} = 1,200 \text{ square feet}$$

Step 4 – The effective sidewall area must be calculated by multiplying the number of feet of aggregate beneath the distribution line by 2, to utilize the absorption area on each side of the trench. For the purposes of this example, assume that a maximum of 4 square feet of the area of the sidewall will be utilized on each trench wall per each lineal foot as follows:

$$2 \times 4 \text{ square feet} = 8 \text{ square feet per each lineal foot of trench}$$

Step 5 – The required trench length is now determined by dividing the required absorption area by the effective sidewall area as follows:

$$1,200 \text{ square feet} \div 8 \text{ square feet/lineal foot} = 150 \text{ lineal feet}$$

Since the maximum length of a distribution line may not exceed 110 feet, a minimum of two trenches of equivalent lengths are required. Therefore, the use of two distribution lines that are 75 feet long with 4 feet of aggregate beneath the distribution lines would be acceptable.

(Added to NAC by Bd. of Health by R129-98, eff. 3-25-99)

NAC 444.8354 Absorption trench system: Design criteria. ([NRS 439.200](#), [444.650](#))

1. The bottom of an absorption trench that is used in an individual sewage disposal system must be level and not less than 1 foot or more than 3 feet in width.
2. Excavations for absorption trenches must be spaced apart at a distance that is equal to or greater than 4 feet plus 2 feet for each foot of depth which the trench is below the bottom of the distribution piping, as measured from the centerline of the trenches.
3. An individual lateral may not be more than 110 feet long.
4. An absorption trench must not be excavated if the soil is extremely wet. Surfaces in an absorption trench which are smeared or compacted must be scarified to the depth to which the soils are smeared or compacted, and all loose material must be removed.
5. Distribution lines must be perforated drain pipe made of polyvinylchloride, unless otherwise approved by the administrative authority. The bottom of the distribution lines must be laid not less than 12 inches or more than 48 inches below the ground surface in continuous straight or curved lines with a slope of not less than 2 inches or more than 4 inches per 100 feet of pipe. Distribution lines must be equipped with end caps or vented to the surface at the end of the lines.
6. At least 12 inches of clean, graded aggregate ranging in size from 3/4 to 2 1/2 inches must be placed in the trench below the distribution line, and the aggregate must extend at least 2 inches over the top of the distribution line.
7. If an absorption trench is more than 6 feet in depth below the finished grade, the aggregate must extend to not less than 12 inches below the ground surface to avoid an anaerobic condition in the trench.
8. The aggregate in an absorption trench must be covered with untreated building paper, straw, geotextile fabric, or a similar covering approved by the administrative authority, and the top of the trench must be overfilled with not less than 4 inches or more than 6 inches of soil.
9. The percolation rate of the soil must be used to determine the design application rate in accordance with the following table:

Percolation Rate (minutes/inch)	Design Application Rate (gallons/square foot)
0-10	1.6
11-15	1.3
16-20	1.1
21-25	1.0
26-30	0.9
31-40	0.8
41-50	0.7
51-60	0.6

If the percolation rate of the soil is greater than 60 minutes per inch, the system must be designed by an engineer.

10. The required capacity of the septic tank must be divided by the design application rate to calculate the minimum absorption area required.
11. The area of the absorption trench must be determined by calculating the size of the effective area of the sidewall needed beneath the distribution line. Not more than 4 feet of aggregate below the distribution line may be used to calculate the effective area of the sidewall, except that aggregate which is in excess of 4 feet below the distribution line may be used to calculate the effective area of the sidewall with the approval of the administrative authority. The required length of distribution line must be determined as follows:

$$\text{The minimum size required for the absorption area (in square feet) divided by [2 times the depth of the aggregate below the distribution line (in feet)] = required length of distribution line (in feet)}$$

12. The following is a diagram of an absorption trench:

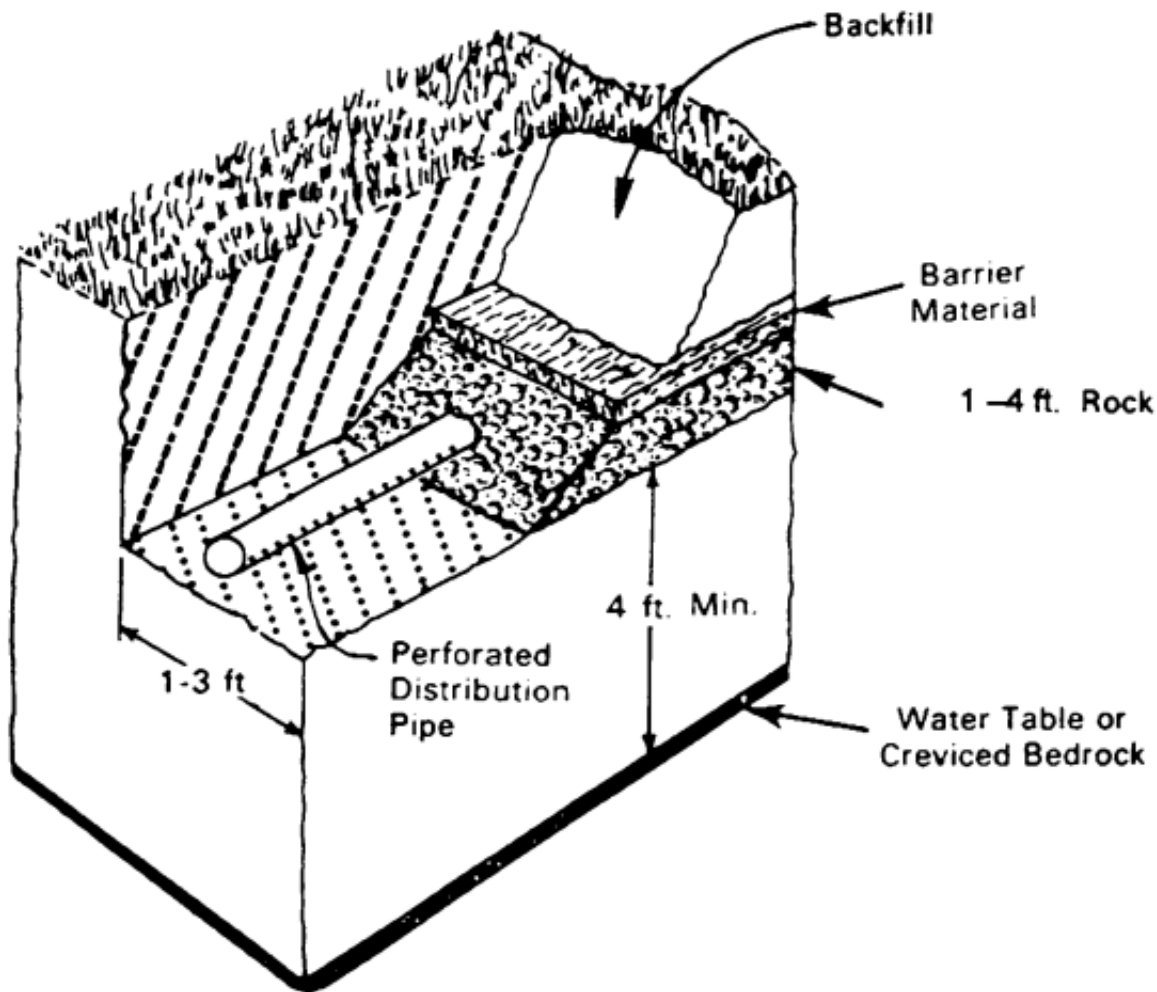

(Added to NAC by Bd. of Health by R129-98, eff. 3-25-99)

NAC 444.8356 Absorption trench system: Inspections. ([NRS 439.200](#), [444.650](#))

1. If a residential system that is designed by a homeowner includes absorption trenches:

(a) The homeowner shall contact the administrative authority for an inspection before covering the system; and

(b) The administrative authority shall inspect the construction of the system by conducting an on-site inspection or, at the discretion of the administrative authority, reviewing photographic documentation provided by the homeowner,

before the covering is placed on the system, to ensure that the system complies with the approved plans.

2. If an individual sewage disposal system that includes absorption trenches is designed by an engineer, the engineer shall, within 30 days after the date on which the construction of the system is completed, submit a letter to the administrative authority stating that the system was constructed in accordance with the approved plans.

(Added to NAC by Bd. of Health by R129-98, eff. 3-25-99; A by R100-07, 10-31-2007)

NAC 444.8358 Absorption bed: General requirements. ([NRS 439.200](#), [444.650](#))

1. If the use of an absorption trench is not practical, an absorption bed may be used as a viable alternative to the standard disposal trench. The bottom of the absorption bed, rather than the area of the sidewall, must serve as the primary absorptive medium.

2. A homeowner may design a residential system that uses an absorption bed for use at his or her residence.

(Added to NAC by Bd. of Health by R129-98, eff. 3-25-99)

NAC 444.8361 Absorption bed: Design criteria. ([NRS 439.200](#), [444.650](#))

1. The absorptive area of an absorption bed must be at least 50 percent larger than the calculated size that would be required for a standard absorption trench.
2. The percolation rate of the soils at the bottom of the absorption bed must not be less than 60 minutes per inch.
3. The effective perimeter of the area of the sidewall beneath the distribution lines, or the depth of the aggregate, must not be less than 12 inches or more than 36 inches. The area of the sidewall may be added to the bottom of the bed when calculating the size of the total absorptive area of the individual sewage disposal system.
4. An absorption bed must not be placed on a slope if the grade of the slope is greater than 8 percent. The bottom of the absorption bed must be level.
5. The invert of the piping for the drain field must be not less than 12 inches or more than 48 inches below the finished grade. The top of the absorption bed must be at least 6 inches below the surface line of the natural soil, and a capping fill must be placed on top of the absorption bed. The capping fill must extend at least 10 feet beyond the perimeter of the leaching area of the absorption bed and must be placed at a minimum depth of 12 inches above the finished grade to allow for settling.
6. An absorption bed must have at least two distribution lines which are separated by not less than 4 feet or more than 6 feet. The distribution lines must be level and placed not less than 3 feet or more than 6 feet from the sidewall of the bed. If a gravity discharge system is used, the distribution line must not be less than 4 inches in diameter. If a pressurized distribution line is used, the line must meet the design guidelines for a pressure distribution system as set forth in [NAC 444.8394](#) and [444.8396](#).
7. A distribution line must not be longer than 110 feet and must be placed on at least 12 inches of clean, graded aggregate ranging in size from 3/4 to 2 1/2 inches. At least 2 inches of aggregate must cover the top of the distribution line. Untreated building paper, straw, geotextile fabric, or any similar covering approved by the administrative authority, must cover the aggregate, and a backfill of soil must be placed over the covering.
8. The owner of an individual sewage disposal system shall take such precautions as are necessary to avoid compacting the bottom of the absorption bed. Any loose or smeared soil must be raked and removed. No vehicles may travel on the area of the absorption bed after excavation is completed.
9. Dosing is required if more than 500 linear feet of distribution lines are required.
10. The following is a diagram of an absorption bed:

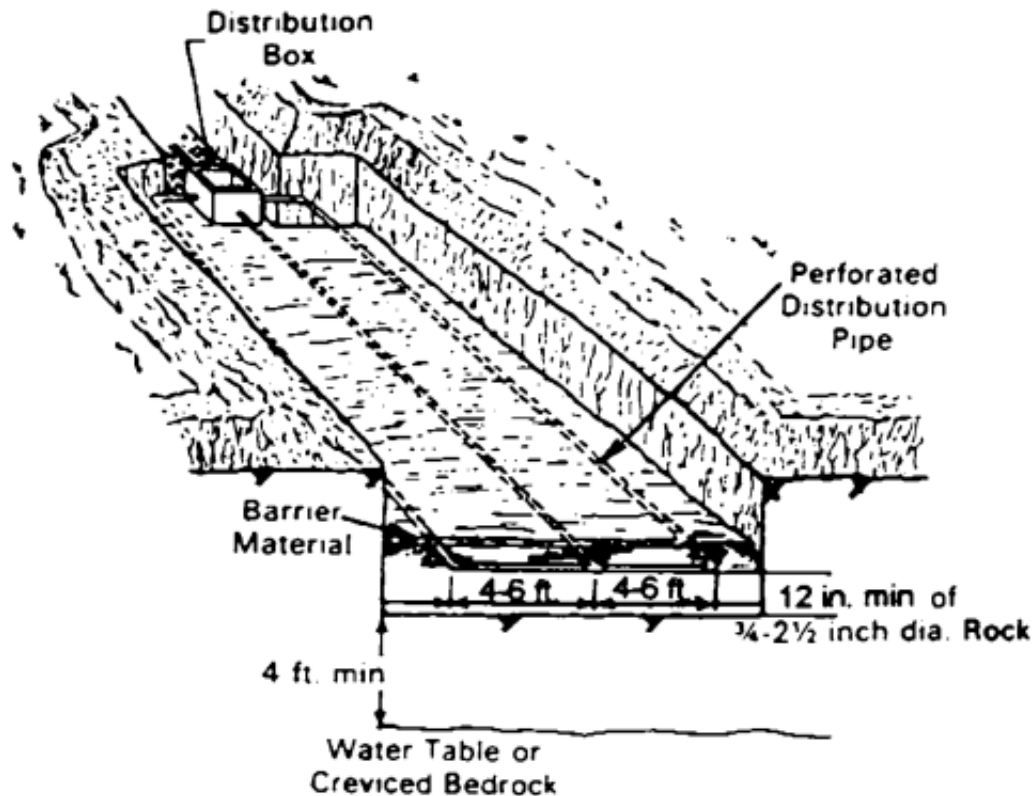

(Added to NAC by Bd. of Health by R129-98, eff. 3-25-99)

NAC 444.8362 Absorption bed: Inspections. ([NRS 439.200](#), [444.650](#))

1. The construction of an individual sewage disposal system that includes an absorption bed must be inspected and verified by an engineer or, if the system is designed by a homeowner as part of a residential system for his or her home, the homeowner. The inspections must be conducted as follows:

(a) Following excavation, the bottom of the absorption bed must be examined to ensure that there is no loose soil and that no smearing conditions exist; and

(b) Upon completion of the installation of the distribution lines in the absorption bed, the individual sewage disposal system must be inspected to ensure that the system complies with the approved design plans.

2. If a residential system that includes an absorption bed is designed by a homeowner:

(a) The homeowner shall contact the administrative authority for an inspection; and

(b) The administrative authority shall inspect the construction by conducting an on-site inspection or, at the discretion of the administrative authority, reviewing photographic documentation provided by the homeowner,

before the covering is placed on the system, to ensure that the system complies with the approved plans.

3. If an individual sewage disposal system is designed by an engineer, the engineer shall, within 30 days after the date on which construction of the system is completed, submit a letter to the administrative authority stating that the system was constructed in accordance with the approved plans.

(Added to NAC by Bd. of Health by R129-98, eff. 3-25-99; A by R100-07, 10-31-2007)

NAC 444.8364 Chamber system: General requirements. ([NRS 439.200](#), [444.650](#))

1. A chamber system may be used in lieu of a standard absorption trench if the installation of an absorption trench is not practical. The bottom area of the chamber system, rather than the area of the sidewall, serves as the primary absorption medium.

2. The manufacturer of a chamber system must apply to the health authority for approval of the chamber system. A chamber system must not be used as a component of an individual sewage disposal system unless the health authority has reviewed and approved the use of the chamber system.

3. A homeowner may design a residential system for use at his or her residence that includes a chamber system.

(Added to NAC by Bd. of Health by R129-98, eff. 3-25-99)

NAC 444.8366 Chamber system: Design criteria. ([NRS 439.200](#), [444.650](#))

1. The health authority shall provide a sizing chart for each chamber system which it approves. The sizing chart must list the number of chamber units required for a specific size of septic tank and percolation rate.

2. The percolation rate of the soil on which a chamber system is placed must not be slower than 60 minutes per inch.

3. The invert of the drain piping entering the first chamber of the system must not be more than 48 inches below the finished grade. The trench depth for a chamber system must not be more than 5 feet below the finished grade. The top of the chamber system must be at least 6 inches below the natural soil surface, and a capping fill must be placed over the top of the chamber system to allow for settling.

4. The absorption trenches for a chamber system must not be longer than 110 feet.

5. Excavations for absorption trenches for a chamber system must be spaced so that there is at least 6 feet between the trenches, as measured from the centerline of the trenches.

6. The bottom of the excavation for an absorption trench to be used in a chamber system must be level. The owner must take such precautions as are necessary to avoid compacting the bottom of the trench. Loose or smeared soil must be raked and removed. No vehicles may travel on the area of an absorption trench after the excavation of the trench.

7. Dosing is required if more than 500 linear feet of absorption trench are required.

8. If a chamber system is used in conjunction with an absorption bed rather than an absorption trench, the chamber system and the absorption bed must comply with the requirements relating to the sizing for absorption beds set forth in [NAC 444.8358](#) and [444.8361](#). The sizing chart provided by the health authority pursuant to this section must not be used to size an absorption bed in which a chamber system will be placed.

(Added to NAC by Bd. of Health by R129-98, eff. 3-25-99; A by R100-07, 10-31-2007)

NAC 444.8368 Chamber system: Inspections. ([NRS 439.200](#), [444.650](#))

1. The construction of an individual sewage disposal system that uses a chamber system must be inspected and verified by an engineer or, if the unit is designed by a homeowner as part of a residential system for his or her home, the homeowner. The inspections must be conducted as follows:

(a) Following excavation, the bottom of each absorption trench or the bottom of the absorption bed, as appropriate, must be inspected to ensure that there is no loose soil and that no smearing conditions exist; and

(b) Upon completion of the installation of the chambers in the absorption trenches or absorption bed, the individual sewage disposal system must be inspected to ensure that the chamber system and the trenches or bed, as appropriate, have been constructed and installed in accordance with the design plans.

2. If a residential system that includes a chamber system is designed by a homeowner:

(a) The homeowner shall contact the administrative authority for an inspection; and

(b) The administrative authority shall inspect the construction of the residential system by conducting an on-site inspection or, at the discretion of the administrative authority, reviewing photographic documentation provided by the homeowner,

before the covering is placed on the system, to ensure that the system complies with the approved plans.

3. If an individual sewage disposal system is designed by an engineer, the engineer shall, within 30 days after the date on which the construction of the individual sewage disposal system is completed, submit a letter to the administrative authority stating the system was constructed in accordance with the approved plans.

(Added to NAC by Bd. of Health by R129-98, eff. 3-25-99; A by R100-07, 10-31-2007)

NAC 444.837 System utilizing graywater for underground irrigation: General requirements. ([NRS 439.200](#), [444.650](#))

1. Graywater may be used for underground irrigation if approved by the administrative authority. A homeowner must obtain a permit to construct, alter or install a system that uses graywater for underground irrigation from the administrative authority before such a system may be constructed, altered or installed.

2. A system that uses graywater for underground irrigation:
 - (a) May be used only for a single-family dwelling.
 - (b) Must not be used in soils which have a percolation rate that is greater than 120 minutes per inch.
 - (c) Must consist of a three-way diversion valve, a holding tank for the graywater and an irrigation system.
 - (d) May be equipped with a pump or siphon, or may rely on gravity to cause the water to flow to the irrigation system.
 - (e) Must not be connected to a system for potable water.
 - (f) Must not result in the surfacing of any graywater.
3. A system that uses graywater for underground irrigation, or any part thereof, must not be located on a lot other than the lot which is the site of the single-family dwelling that discharges the graywater to be used in the system.
(Added to NAC by Bd. of Health by R129-98, eff. 3-25-99)

NAC 444.8372 System utilizing graywater for underground irrigation: Application to construct, alter or install system; design criteria. ([NRS 439.200](#), [444.650](#))

1. An application to construct, alter or install a system that uses graywater for underground irrigation must include:
 - (a) Detailed plans of the system to be constructed, altered or installed;
 - (b) Detailed plans of the existing and proposed sewage disposal system; and
 - (c) Data from percolation tests conducted in accordance with [NAC 444.796](#) to [444.7968](#), inclusive.
2. A holding tank for graywater must:
 - (a) Be watertight and constructed of solid, durable materials that are not subject to excessive corrosion or decay.
 - (b) Have a minimum capacity of 50 gallons.
 - (c) Have an overflow and an emergency drain. The overflow and emergency drain must not be equipped with a shutoff valve.
3. A three-way diversion valve, emergency drain and overflow must be permanently connected to the building drain or building sewer and must be located upstream from any septic tanks. The required size of an individual sewage disposal system must not be reduced solely because a system that uses graywater for underground irrigation is being used in conjunction with the individual sewage disposal system.
4. The piping for a system that uses graywater for underground irrigation which discharges into the holding tank or is directly connected to the building sewer must be downstream of any vented trap to protect the building from possible sewer gases.
5. The estimated discharge of a system that uses graywater for underground irrigation must be calculated based on the number of bedrooms in the building, as follows:
 - (a) For the first bedroom, the estimated discharge of graywater is 80 gallons per day; and
 - (b) For each additional bedroom, the estimated discharge of graywater is 40 gallons per day.
6. The absorption area for an irrigation system that includes a system that uses graywater for underground irrigation must be calculated in accordance with the following table:

Percolation Rate (minutes per inch)	Minimum Square Feet Per 100 Gallons Discharged Per Day
0-20	20
21-40	40
41-60	60

7. The following is a diagram of a system that uses graywater for underground irrigation:

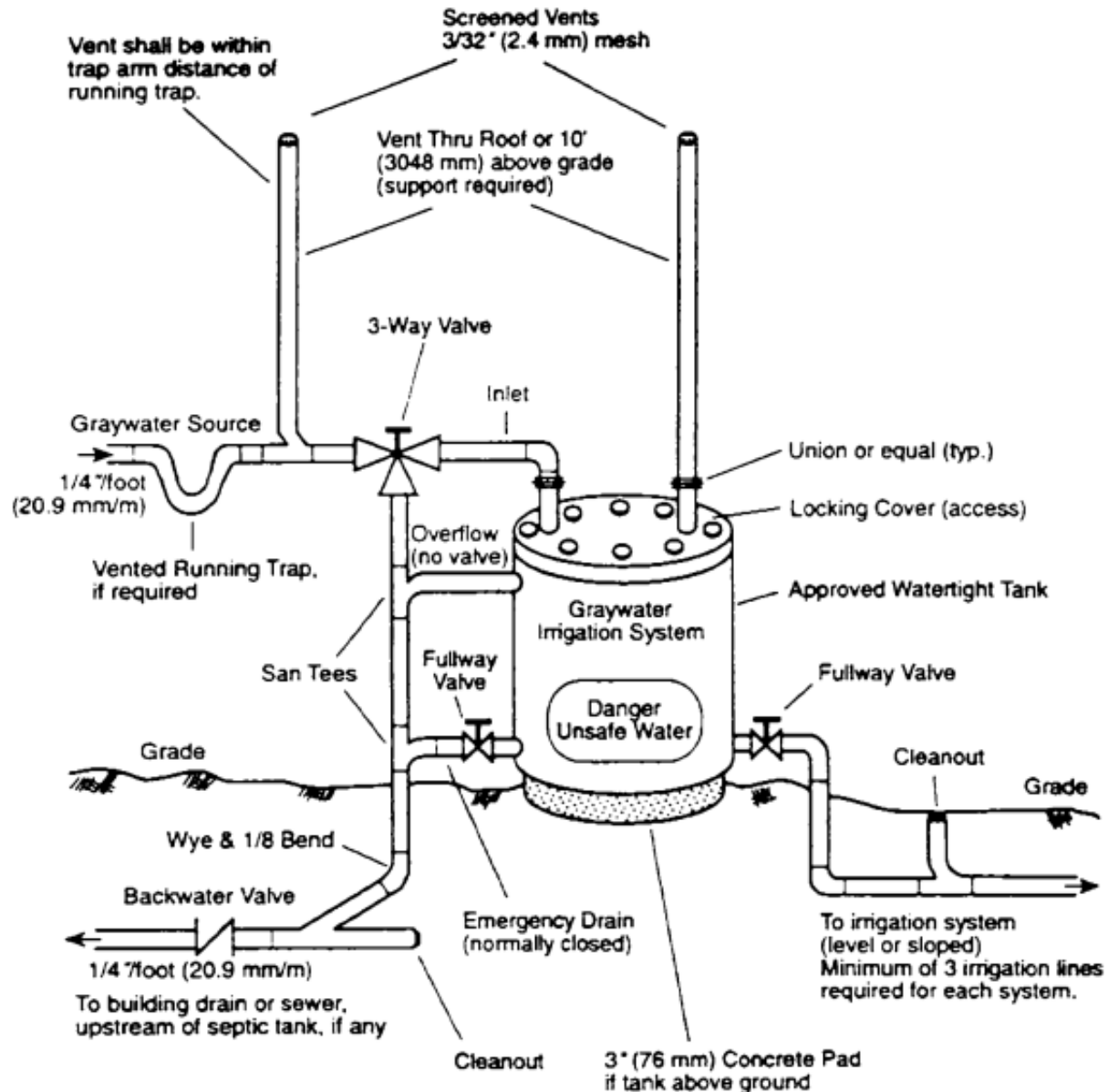

(Added to NAC by Bd. of Health by R129-98, eff. 3-25-99)

NAC 444.8374 Alternative absorption system: General requirements. ([NRS 439.200](#), [444.650](#))

1. If an individual sewage disposal system that uses absorption trenches pursuant to [NAC 444.8352](#), [444.8354](#) and [444.8356](#) cannot be used because of limiting conditions, including, without limitation, the existence of high groundwater, a highly permeable stratum, sloping terrain, bedrock, or a layer of semi-impervious soil with a percolation rate that is slower than 60 minutes per inch, the health authority may approve the use of an alternative absorption system if the alternative absorption system is designed by an engineer.

2. Except as otherwise required by design modifications approved by the health authority, an alternative absorption system must comply with the regulations which pertain to a standard disposal trench.

3. A connecting fixture used in an alternative absorption system must be a low-flow fixture designed for an individual sewage disposal system that is used where the percolation rates are greater than 60 minutes per inch. Each such fixture must be specifically identified by the engineer on the design plans for the alternative absorption system.

4. An engineer who is designing an alternative absorption system must consult the *Design Manual for*

On-site Wastewater Treatment and Disposal Systems which is published by the Environmental Protection Agency (reference document number PB83-219907), and contact the health authority for design parameters for the alternative absorption system before the engineer submits the design plans to the health authority.

(Added to NAC by Bd. of Health by R129-98, eff. 3-25-99)

NAC 444.8376 Stepped network of trenches utilizing relief lines: General requirements. (NRS 439.200, 444.650)

1. On sloping terrain where a conventional individual sewage disposal system cannot be installed or is impractical, a stepped network of trenches utilizing relief lines between the trenches may be used.

2. A stepped network of trenches utilizing relief lines must:

(a) Be designed by an engineer; and

(b) Allow the effluent from a completely filled trench to overflow into a trench at a lower elevation, as shown in subsection 5 of [NAC 444.8378](#).

(Added to NAC by Bd. of Health by R129-98, eff. 3-25-99)

NAC 444.8378 Stepped network of trenches utilizing relief lines: Design criteria. (NRS 439.200, 444.650)

1. The size of the required absorption area for a stepped network of trenches utilizing relief lines must be calculated based on percolation testing and must conform to the requirements for the sizing of a standard trench. Percolation testing must be conducted at the location of each stepped trench and the size of the required absorption area must be calculated based on the slowest percolation rate.

2. The invert of the overflow section must be located not less than 1 inch or more than 2 inches above the top of the disposal trench distribution line. The leaching aggregate must extend at least 4 inches above the disposal distribution line, as shown in subsection 5.

3. To minimize the possibility that the slope will fail or that effluent will surface down slope, the design of the disposal field must comply with the slope requirements set forth in [NAC 444.794](#).

4. Trenches for a stepped network of trenches utilizing relief lines must be spaced at least 10 feet apart.

5. The following is a diagram of a stepped network of trenches utilizing relief lines:

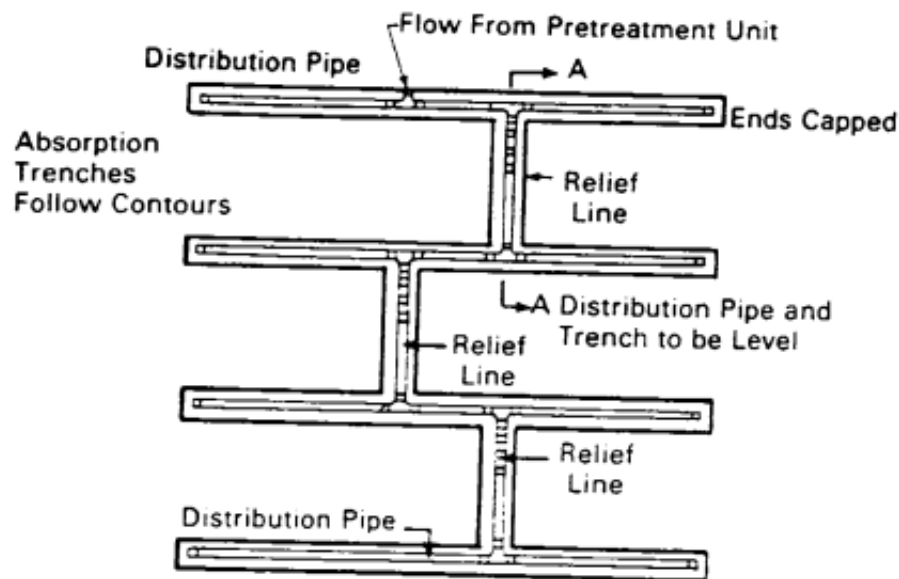

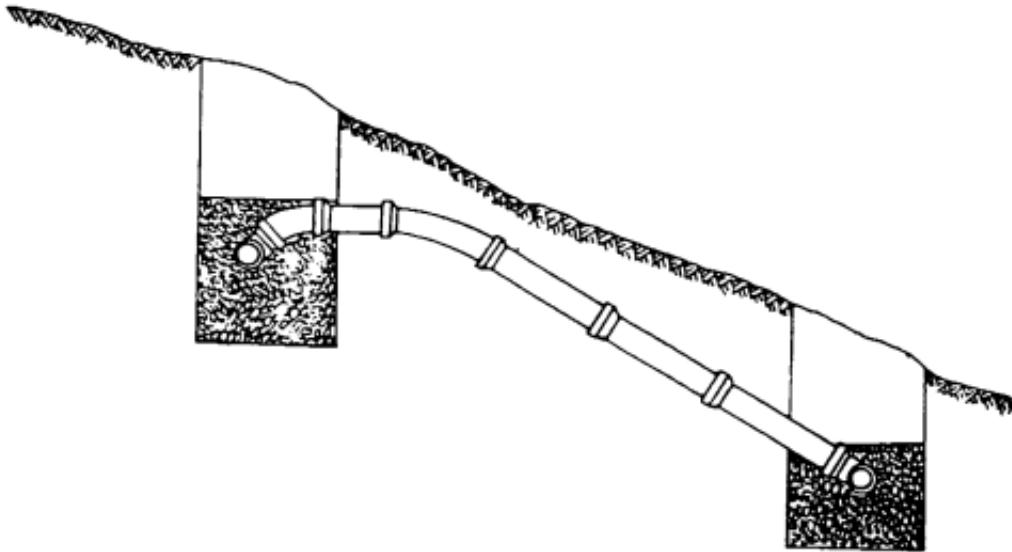

(Added to NAC by Bd. of Health by R129-98, eff. 3-25-99)

NAC 444.8381 Stepped network of trenches utilizing relief lines: Inspections. ([NRS 439.200](#), [444.650](#))

1. An engineer shall:
 - (a) Inspect each trench of a stepped network of trenches utilizing relief lines before the trench is covered; and
 - (b) Verify that the elevation of each disposal line and invert for overflow conforms with the approved plans.
2. The engineer shall, within 30 days after the date on which the construction of the system is completed, submit a letter to the health authority stating that the system was constructed in accordance with the approved plans.

(Added to NAC by Bd. of Health by R129-98, eff. 3-25-99)

NAC 444.8382 Capping fill trench: General requirements. ([NRS 439.200](#), [444.650](#))

1. A capping fill trench may be used where conditions relating to high groundwater preclude the installation of a standard absorption trench.
 2. A capping fill trench must be designed by an engineer.
- (Added to NAC by Bd. of Health by R129-98, eff. 3-25-99)

NAC 444.8384 Capping fill trench: Design criteria. ([NRS 439.200](#), [444.650](#))

1. The soil surrounding and beneath the bottom of a capping fill trench must have a percolation rate that is greater than 2 minutes per inch, but less than or equal to 120 minutes per inch. The required area of the absorption trench must be determined by calculating the size of the effective sidewall pursuant to subsection 11 of [NAC 444.8354](#).
2. A minimum depth of 4 feet must be maintained between the bottom of the capping fill trench and the level of the seasonal high groundwater, any impermeable barrier or any other limiting features.
3. A capping fill trench must not be installed on a slope that is greater than 10 percent.
4. The invert of the disposal drain pipe must be placed not more than 12 inches below the existing grade of the native soil. At least 2 inches of aggregate must be placed above the disposal drain pipe. Untreated building paper, straw, geotextile fabric, or any other similar covering approved by the health authority, must be placed above the aggregate before the placement of the capping fill.
5. The absorption trenches must be constructed before the capping fill is constructed.

6. The capping fill must extend at least 10 feet beyond the sidewall of the absorption trench. The vegetative mat in the fill area must be disrupted by scarification or plowing. The owner of the system shall take such precautions as are necessary to prevent compaction of the scarified area. No vehicles may travel on the capping fill.

7. The native soil and the applied fill must be mixed at their point of interface. The soil to be used as fill must be of a texture similar to the native topsoil. The fill must be placed over the aggregate to a depth of not less than 12 inches or more than 18 inches.

8. The fill must be evenly graded to provide positive drainage away from the absorption trenches and toward the perimeter of the capping fill. The fill material must be placed in such a manner so as to prevent the compaction of the scarified soil at the interface of the native soil and fill. Plant vegetation must be established on the top of the fill to reduce the potential for the erosion of the capping fill.

9. A capping fill trench must not be used if the soil in which the capping fill is to be placed exhibits saturated conditions.

10. The following is a diagram of a capping fill trench:

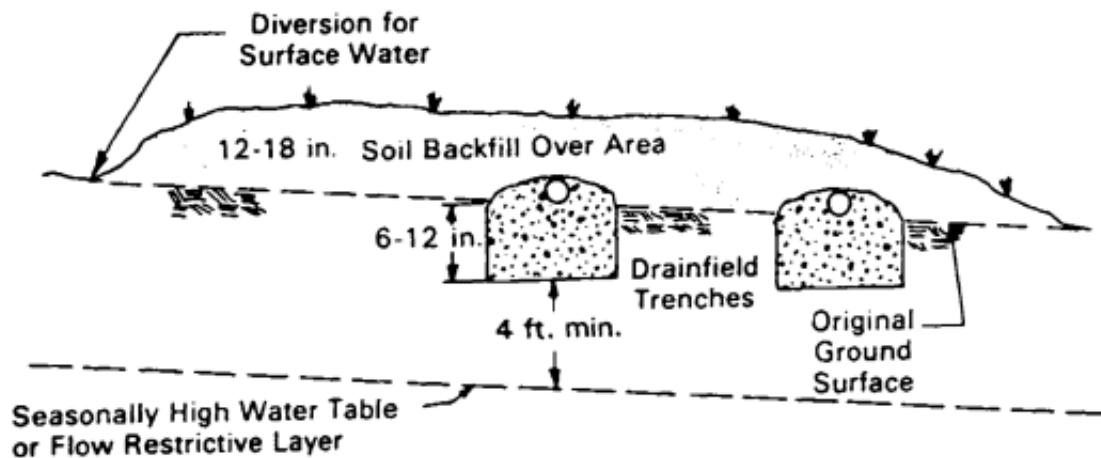

(Added to NAC by Bd. of Health by R129-98, eff. 3-25-99)

NAC 444.8386 Capping fill trench: Inspections. ([NRS 439.200](#), [444.650](#))

1. An engineer shall inspect the construction of a capping fill:

(a) Upon the completion of the installation of the distribution lines in the absorption trenches.

(b) When the fill area has been scarified. The engineer shall inspect the fill and native soils to ensure that they are not excessively moist and are of similar texture.

(c) When the capping fill has been placed:

(1) To ensure that there is an adequate interface of the fill and soils at the surface; and

(2) To verify the dimensions of the capping fill.

2. The engineer shall, within 30 days after the date on which the construction of the system is completed, submit a letter to the health authority stating the system was constructed in accordance with the approved plans.

(Added to NAC by Bd. of Health by R129-98, eff. 3-25-99)

NAC 444.8388 Elevated mound system: General requirements. ([NRS 439.200](#), [444.650](#))

1. An elevated mound system consists of:

(a) A suitable fill material;

(b) An absorption area and distribution network; and

(c) A soil cap.

2. With an elevated mound system:

- (a) The effluent must be gravity fed, pumped or siphoned into the absorption area and through a distribution network located in the upper part of the absorption bed made of coarse aggregate;
- (b) The effluent must pass through the aggregate and infiltrate the fill material; and
- (c) Treatment of the wastewater must occur as it passes through the fill material and the unsaturated zone of the natural soil.

3. An individual sewage disposal system that uses an elevated mound system must be designed by an engineer.

(Added to NAC by Bd. of Health by R129-98, eff. 3-25-99)

NAC 444.839 Elevated mound system: Design criteria. ([NRS 439.200](#), [444.650](#))

1. An elevated mound system must not be constructed on a slope that is:

- (a) Greater than 6 percent, if the soils comprising the slope have percolation rates that are slower than 60 minutes per inch; or
- (b) Greater than 12 percent, if the soils comprising the slope have percolation rates that are equal to or faster than 60 minutes per inch.

2. At least 4 feet of unsaturated soil or fill material, or any combination thereof, must be maintained between the top of the seasonal high groundwater table or any impervious barrier such as bedrock. On sloping sites, the depth of unsaturated soil and fill material must be increased to maintain a level bed.

3. Percolation tests must be conducted at the depth anticipated by the engineer as being the point of interface of the native soil and sand fill, and at a depth of 20 inches below the surface of the native soil. The size of the required basal area of the elevated mound system must be based on the slowest percolation rate.

4. The fill material for the elevated mound system must meet the following criteria:

Sieve Size	Percent by Weight Passing Sieve
3/8 inch	100
No. 4	95-100
No. 8	80-100
No. 16	45-85
No. 30	15-60
No. 50	3-15
No. 100	0-4

5. Whenever practical, the bed for an elevated mound system must be a rectangular bed with a long axis that is parallel to the contour of the slope to minimize the possibility of seepage from the base of the elevated mound. The minimum area of the bed must be based on an estimated flow of 150 gallons per day per bedroom and a design application rate of 1.2 gallons per day per square foot. The bed must be filled with at least 9 inches of clean, graded aggregate that ranges in size from 3/4 to 2 1/2 inches.

6. The basal area of an elevated mound system must be sufficiently large enough to absorb the wastewater before it reaches the perimeter of the elevated mound to avoid the surfacing of the effluent. The minimum basal area must be based on the minimum capacity for a septic tank required by [NAC 444.8306](#) and a design infiltration rate as follows:

--	--

Percolation Rate (minutes per inch)	Infiltration Rate (gallons per square foot)
0-30	1.2
31-45	.75
46-60	.50
61-120	.25

7. If the site on which an elevated mound system will be located is:

(a) Flat, the entire basal area, calculated as length multiplied by width, must be used to determine the area needed for the elevated mound system.

(b) Sloping, only the area below and down slope from the absorption bed, calculated as $W \times (A + I)$, must be used to determine the area needed for the elevated mound system, where:

(1) "W" equals the width of the absorption bed;

(2) "A" equals the length of the absorption bed; and

(3) "I" equals the required side slope of the elevated mound system as measured from the edge of the absorption bed to the perimeter of the mound in accordance with subsection 8.

8. The side slopes of the elevated mound system must extend in a horizontal to vertical ratio that is at least 3 to 1. The entire absorption bed must be covered with at least 1 foot of topsoil. The topsoil cap, which must be placed at the center of the mound, must maintain a minimum slope of 2 percent away from the crown. Untreated building paper, straw, geotextile fabric, or any similar covering approved by the health authority, must be placed over the aggregate in the absorption bed before the topsoil is placed.

9. At least one observation standpipe which extends down to the fill sand must be installed in the absorption bed.

10. The following is a diagram of an elevated mound:

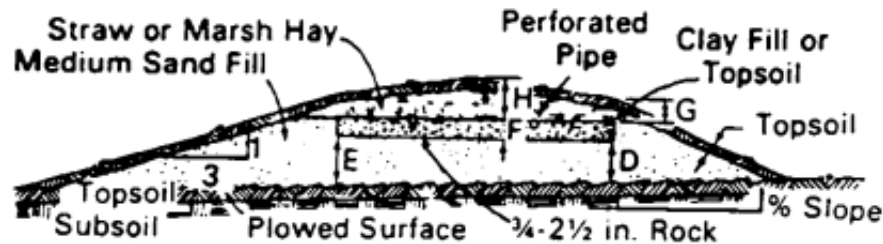

(A) Cross Section

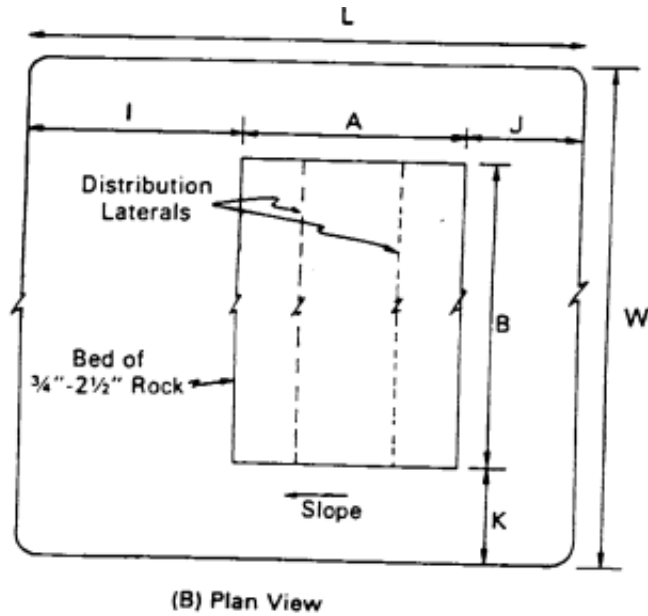

(Added to NAC by Bd. of Health by R129-98, eff. 3-25-99; A by R100-07, 10-31-2007)

NAC 444.8392 Elevated mound system: Inspections. ([NRS 439.200](#), [444.650](#))

1. The construction of an elevated mound system must be inspected and verified by an engineer when:

- The basal area of the elevated mound has been scarified;
- The distribution lines have been placed in the aggregate absorption bed;
- The topsoil cap has been placed; and
- If a dosing system is used, all the pumps, switches and alarms associated with the dosing system have been installed. The engineer shall verify that the operational liquid levels in the dosing tank are set as specified by the design plans.

2. The engineer must develop a manual for the operation and maintenance for the elevated mound system and submit the manual to the health authority for review before a permit or other type of approval authorizing occupancy may be issued.

3. The engineer shall, within 30 days after the date on which the project is completed, submit a letter to the health authority stating that the system was constructed in accordance with the approved plans.

(Added to NAC by Bd. of Health by R129-98, eff. 3-25-99)

NAC 444.8394 Pressure distribution system: General requirements. ([NRS 439.200](#), [444.650](#))

1. A pressure distribution system may be used in conjunction with an elevated mound, absorption bed or absorption trench system.

2. An individual sewage disposal system that uses a pressure distribution system must be designed by an engineer.

(Added to NAC by Bd. of Health by R129-98, eff. 3-25-99)

NAC 444.8396 Pressure distribution system: Design criteria. ([NRS 439.200](#), [444.650](#))

1. A pump must be used to pressurize a pressure distribution system. A siphon may be used in lieu of a pump if adequate elevation head is available. The active dosing volume must be approximately 10 times the total volume of the distribution pipe.

2. A solid delivery pipe which goes from the dosing tank to the perforated distribution piping must be placed below the frost line. The delivery pipe must maintain a downward slope from the distribution lines to the dosing tank to ensure that the line will drain between discharges. Check valves and other devices that prevent backflow through the pump must not be used so that effluent may, when necessary, drain back to the dosing tank to protect the pipe from freezing.

3. To reduce the potential for plugging and clogging the distribution lines, the diameter of the discharge hole must be 3/8 inch or more. The rate of discharge for various-sized holes at various pressures are set forth in the following table:

DISCHARGE RATES AT VARIOUS PRESSURES (gallons per minute)				
Pressure		Hole Diameter		
Per Foot of Water	Per Square Inch	3/8 Inch	7/16 Inch	1/2 Inch
1	0.43	1.66	2.26	2.95
2	0.87	2.34	3.19	4.17
3	1.30	2.87	3.91	5.10
4	1.73	3.31	4.51	5.89
5	2.17	3.71	5.04	6.59

4. Friction losses in schedule 40 plastic pipe are listed in the following table:

FRICTION LOSS IN SCHEDULE 40 PLASTIC PIPE; C = 150 (ft/100 ft)									
Flow in gallons per minute	Pipe Diameter (inches)								
	1	1 1/4	1 1/2	2	3	4	6	8	10
1	0.07								
2	0.28	0.07							
3	0.60	0.16	0.07						
4	1.01	0.25	0.12						
5	1.52	0.39	0.18						
6	2.14	0.55	0.25	0.07					
7	2.89	0.76	0.36	0.10					
8	3.63	0.97	0.46	0.14					

9	4.57	1.21	0.58	0.17					
10	5.50	1.46	0.70	0.21					
11		1.77	0.84	0.25					
12		2.09	1.01	0.30					
13		2.42	1.17	0.35					
14		2.74	1.33	0.39					
15		3.06	1.45	0.44	0.07				
16		3.49	1.65	0.50	0.08				
17		3.93	1.86	0.56	0.09				
18		4.37	2.07	0.62	0.10				
19		4.81	2.28	0.68	0.11				
20-24		5.23	2.46	0.74	0.12				
25-29			3.75	1.10	0.16				
30-34			5.22	1.54	0.23				
35-39				2.05	0.30	0.07			
40-44				2.62	0.39	0.09			
45-49				3.27	0.48	0.12			
50-59				3.98	0.58	0.16			
60-69					0.81	0.21			
70-79					1.08	0.28			
80-89					1.38	0.37			
90-99					1.73	0.46			
100-149					2.09	0.55	0.07		

150-199						1.17	0.16		
200-249							0.28	0.07	
250-299							0.41	0.11	
300-349							0.58	0.16	
350-399							0.78	0.20	0.07
400-449							0.99	0.26	0.09
450-499							1.22	0.32	0.11
500-599								0.38	0.14
600-699								0.54	0.18
700-799								0.72	0.24
800-899									0.32
900-999									0.38
1000 or more									0.46

5. Laterals must be spaced so that they are not less than 4 feet or more than 6 feet apart. The outside laterals must be placed at a distance from the perimeter of the bed that is equal to 1/2 of the distance between the laterals.

6. Distribution lines in the pressure distribution system must be looped.

7. The required lateral pipe diameters for various hole diameters, hole spacings, and lateral lengths for plastic pipe are shown in the following diagram:

REQUIRED LATERAL PIPE DIAMETERS FOR VARIOUS HOLE DIAMETERS, HOLE SPACINGS, AND LATERAL LENGTHS^a
(FOR PLASTIC PIPE ONLY)

Lateral Length (ft)	LATERAL DIAMETER (IN)																																		
	Hole Diameter (in) 1/4							Hole Diameter (in) 5/16							Hole Diameter (in) 3/8							Hole Diameter (in) 7/16							Hole Diameter (in) 1/2						
	Hole Spacing (ft)							Hole Spacing (ft)							Hole Spacing (ft)							Hole Spacing (ft)							Hole Spacing (ft)						
	2	3	4	5	6	7	2	3	4	5	6	7	2	3	4	5	6	7	2	3	4	5	6	7	2	3	4	5	6	7					
10	1"							1"							1"							1"							1"						
15	1"							1"							1"							1"							1"						
20	1"							1"							1"							1"							1"						
25	1"							1"							1"							1"							1"						
30	1"							1"							1"							1"							1"						
35	1"							1"							1"							1"							1"						
40	1"							1"							1"							1"							1"						
45	1"							1"							1"							1"							1"						
50	1"							1"							1"							1"							1"						

^a Computed for plastic pipe only. The Hazen-Williams equation was used to compute headlosses through each pipe segment (Hazen-Williams C = 150). The orifice equation for sharp-edged orifices (discharge coefficient = 0.6) was used to compute the discharge rates through each orifice. The maximum lateral length for a given hole and spacing was defined as that length at which the difference between the rates of discharge from the distal end and the supply end orifice reached 10 percent of the distal end orifice discharge rate.

8. Manifold diameters for various manifold lengths, number of laterals, and lateral discharge rates for plastic pipe are shown in the following diagram:

Flow per Lateral (gpm)	MANIFOLD DIAMETER (IN)																						Flow per Lateral (gpm)
	Manifold Length (ft)																						
	5	10	15	20	25	30	35	40	45	50	5	10	15	20	25	30	35	40	45	50			
5	Number of Laterals with Central Manifold																						10
10	Number of Laterals with End manifold																						20
15	Number of Laterals with End manifold																						30
20	Number of Laterals with End manifold																						40
25	Number of Laterals with End manifold																						50

^a Computed for plastic pipe only. The Hazen-Williams equation was used to compute headlosses through each segment (Hazen-Williams C = 150). The maximum manifold length for a given lateral discharge rate and spacing was defined as that length at which the difference between the heads at the distal and supply ends of the manifold exceeded 10 percent of the head at the distal end.

(Added to NAC by Bd. of Health by R129-98, eff. 3-25-99)

FACILITIES FOR MANAGEMENT OF HAZARDOUS WASTE

General Provisions

NAC 444.842 Definitions. ([NRS 459.485](#)) As used in [NAC 444.842](#) to [444.8482](#), inclusive, unless the context otherwise requires, the words and terms defined in [NAC 444.8422](#) to [444.8444](#), inclusive, have the meanings ascribed to them in those sections.

(Added to NAC by Environmental Comm'n, eff. 7-22-87; A 4-18-90; 4-18-90; 5-27-92; 3-1-94; R208-03, 4-16-2004)

NAC 444.8422 "Administrator" defined. ([NRS 459.485](#)) "Administrator" means the Administrator of the Division.

(Added to NAC by Environmental Comm'n, eff. 7-22-87)

NAC 444.84225 "Class 3 modification" defined. ([NRS 459.485](#)) "Class 3 modification" has the meaning ascribed to it in Appendix I of 40 C.F.R. § 270.42, as adopted by reference in [NAC 444.8632](#).

(Added to NAC by Environmental Comm'n, eff. 3-1-94; A by R126-03, 4-13-2004)

NAC 444.8423 "Commission" defined. ([NRS 459.485](#)) "Commission" means the State Environmental Commission.

(Added to NAC by Environmental Comm'n, eff. 4-18-90)

NAC 444.84235 "Delisted waste" defined. ([NRS 459.485](#)) "Delisted waste" means waste that the EPA removed from the list of hazardous wastes located in 40 C.F.R. Part 261, Subpart D, as a result of a successful petition for a regulatory amendment pursuant to 40 C.F.R. § 260.20 or 40 C.F.R. § 260.22.

(Added to NAC by Environmental Comm'n by R208-03, eff. 4-16-2004)

NAC 444.8424 "Disposal" defined. ([NRS 459.485](#)) "Disposal" has the meaning ascribed to it in [NRS 459.425](#).

(Added to NAC by Environmental Comm'n, eff. 7-22-87)

NAC 444.8426 "Division" defined. ([NRS 459.485](#)) "Division" means the Division of Environmental Protection of the State Department of Conservation and Natural Resources.

(Added to NAC by Environmental Comm'n, eff. 7-22-87)

NAC 444.8427 "Facility for community recycling" defined. ([NRS 459.485](#)) "Facility for community recycling" means a facility for recycling hazardous waste which has a yearly capacity that is not more than twice the amount of the type of hazardous waste proposed to be recycled that is generated within the region in this State in which the facility is or is proposed to be located, as determined by the generation rate contained in the biennial report required by the provisions of 40 C.F.R. § 262.41, as that section existed on July 1, 2008.

(Added to NAC by Environmental Comm'n, eff. 4-18-90; A 9-19-90; 11-9-95; R202-97, 3-5-98; R124-98, 11-2-98; R170-99, 1-26-2000; R037-01, 10-25-2001; R104-02, 10-18-2002; R126-03, 4-13-2004; R175-05, 5-4-2006; R137-07, 1-30-2008; R015-08, 4-17-2008; R153-08, 4-23-2009)

NAC 444.84275 "Facility for community storage" defined. ([NRS 459.485](#)) "Facility for community storage" means a facility for the storage and consolidation of hazardous waste which has a yearly capacity that is not more than twice the amount of hazardous waste that is generated within the county in which the facility is or is proposed to be located, as determined by the generation rate contained in the biennial report required by the provisions of 40 C.F.R. § 262.41, as that section existed on July 1, 2008.

(Added to NAC by Environmental Comm'n, eff. 4-18-90; A 9-19-90; 11-9-95; R202-97, 3-5-98; R124-98, 11-2-98; R170-99, 1-26-2000; R037-01, 10-25-2001; R104-02, 10-18-2002; R126-03, 4-13-2004; R175-05, 5-4-2006; R137-07, 1-30-2008; R015-08, 4-17-2008; R153-08, 4-23-2009)

NAC 444.8428 "Facility for the management of hazardous waste" defined. ([NRS 459.485](#)) "Facility for the management of hazardous waste" includes the contiguous land, any structures,

other appurtenances or improvements on the land and any mobile units for the treatment of hazardous waste which are used for the management of hazardous waste. Such a facility may contain more than one unit for the management of hazardous waste.

(Added to NAC by Environmental Comm'n, eff. 7-22-87; A 3-1-94)

NAC 444.84285 "Facility for the recycling of hazardous waste" defined. ([NRS 459.485](#)) "Facility for the recycling of hazardous waste" includes the contiguous land and any structures, other appurtenances or improvements on the land which are used for the recycling of hazardous waste.

(Added to NAC by Environmental Comm'n, eff. 3-1-94)

NAC 444.843 "Hazardous waste" defined. ([NRS 459.485](#))

1. "Hazardous waste" has the meaning ascribed to it in [NRS 459.430](#).
2. The term includes any:
 - (a) Hazardous waste or constituent of hazardous waste which is subject to regulation under 40 C.F.R. Part 261;
 - (b) Waste containing polychlorinated biphenyl; and
 - (c) Waste brought into this State which is designated as hazardous waste in the state of its origin unless the waste:
 - (1) Is remediation waste or delisted waste;
 - (2) Does not meet the requirements of paragraph (a); and
 - (3) Is disposed of at a facility for the management of hazardous waste.

(Added to NAC by Environmental Comm'n, eff. 7-22-87; A 9-19-90; R170-99, 1-26-2000; R208-03, 4-16-2004)

NAC 444.8432 "Management of hazardous waste" defined. ([NRS 459.485](#)) "Management of hazardous waste" has the meaning ascribed to it in [NRS 459.435](#) and includes, but is not limited to, the open burning of hazardous waste, open detonation of hazardous waste, and incineration of hazardous waste, including burning for the recovery of energy or destruction in boilers or industrial furnaces.

(Added to NAC by Environmental Comm'n, eff. 7-22-87; A 3-1-94)

NAC 444.8433 "Mobile unit for the recycling of hazardous waste" defined. ([NRS 459.485](#)) "Mobile unit for the recycling of hazardous waste" means any transportable equipment which is used to perform recycling of a hazardous waste and is not permanently stationed at a single facility.

(Added to NAC by Environmental Comm'n, eff. 3-1-94)

NAC 444.84335 "New or expanding facility for the management of hazardous waste" defined. ([NRS 459.485](#)) "New or expanding facility for the management of hazardous waste" means a facility for the management of hazardous waste:

1. For which a permit is required pursuant to 40 C.F.R. Part 124, Subparts A and B, and Part 270, Subparts A to F, inclusive, but which was not issued the permit before March 28, 1990; or
2. Which has an effective permit required pursuant to 40 C.F.R. Part 124, Subparts A and B, and Part 270, Subparts A to F, inclusive, and whose owner or operator proposes the expansion of an existing unit or the addition of a new unit which requires a class 3 modification of the permit.

(Added to NAC by Environmental Comm'n, eff. 3-1-94)

NAC 444.8434 "Person" defined. ([NRS 459.485](#)) "Person" has the meaning ascribed to it in [NRS 459.445](#).

(Added to NAC by Environmental Comm'n, eff. 7-22-87)

NAC 444.8436 "Polychlorinated biphenyl" defined. ([NRS 459.485](#)) "Polychlorinated biphenyl" has the meaning ascribed to it in [NAC 444.9435](#).

(Added to NAC by Environmental Comm'n, eff. 7-22-87)

NAC 444.8437 “Recycling” defined. (NRS 459.485) “Recycling” means any process which uses hazardous waste to produce products or energy or to recover materials.
 (Added to NAC by Environmental Comm’n, eff. 4-18-90)

NAC 444.84375 “Remediation waste” defined. (NRS 459.485) “Remediation waste” has the meaning ascribed to it in 40 C.F.R. § 260.10.
 (Added to NAC by Environmental Comm’n by R208-03, eff. 4-16-2004)

NAC 444.8438 “Storage” defined. (NRS 459.485) “Storage” has the meaning ascribed to it in [NRS 459.450](#).
 (Added to NAC by Environmental Comm’n, eff. 7-22-87)

NAC 444.8442 “Treatment” defined. (NRS 459.485) “Treatment” has the meaning ascribed to it in [NRS 459.455](#).
 (Added to NAC by Environmental Comm’n, eff. 7-22-87)

NAC 444.8444 “Waste containing polychlorinated biphenyl” defined. (NRS 459.485) “Waste containing polychlorinated biphenyl” has the meaning ascribed to it in [NAC 444.945](#).
 (Added to NAC by Environmental Comm’n, eff. 7-22-87)

NAC 444.8446 Fee for processing and review of certain applications: Payment; amount; deposit; return of excess. (NRS 459.485, 459.500, 459.520)

1. Except as otherwise provided in subsection 4, the:

- (a) Owner or operator of a facility for the management of hazardous waste, for which a permit is required for its operation, closure or care after closure;
- (b) Person who applies for a written determination pursuant to [NAC 444.8455](#); or
- (c) Person who applies for a certificate of designation pursuant to [NAC 444.8458](#),

Ê must, before the Administrator may issue a permit, written determination or certificate of designation, pay a fee to the Division to offset the cost to process and review the application. The amount of the fee is \$50 for each hour of staff time devoted to processing and reviewing the application for the facility, plus the amount paid to consultants by the Division in connection with the application. The total fee must not exceed:

Regulated Unit	Maximum Fee
Landfill, boiler, industrial furnace or incinerator.....	\$50,000
Treatment.....	50,000
Surface impounds, areas for thermal treatment, waste piles.....	25,000
Storage.....	25,000
Facility for recycling.....	10,000
Mobile unit for the recycling of hazardous waste.....	10,000

2. If the facility contains more than one type of regulated unit, the operator is not required to pay more for each application than the maximum fee for the regulated unit to which the highest fee is applicable, unless the facility contains a landfill and an incinerator. If the facility contains a landfill and an incinerator, the

operator is not required to pay more than \$100,000 for an application.

3. Except as otherwise provided in subsection 4, an applicant for a permit, written determination or certificate of designation shall deposit the maximum fee with the Division at the time of submission. The Division shall maintain an accurate account of the time devoted to each application by the Division and the amount paid to consultants by the Division. The Division shall return to the applicant any amount remaining from the maximum fee after a deduction for the fee for staff time and the amount paid to consultants.

4. An applicant for a written determination for a mobile unit for the recycling of hazardous waste shall deposit at least 10 percent of the maximum fee with the Division at the time of submission. The Division shall maintain an accurate account of the time devoted to each application by the Division and the amount paid to consultants by the Division. If the deposit submitted pursuant to this subsection is greater than the fee for staff time and the amount paid to consultants, the Division shall return to the applicant the excess amount. If the fee for staff time and the amount paid to consultants is greater than the deposit submitted to the Division:

(a) The Division shall bill the applicant for the balance; and

(b) Payment from the applicant on the balance must be received by the Division before it issues a decision on the written determination.

(Added to NAC by Environmental Comm'n, eff. 7-22-87; A 4-18-90; 5-27-92; 3-1-94)

NAC 444.8447 Fees for emergency permit. ([NRS 459.485](#), [459.500](#), [459.520](#))

1. Except as otherwise provided in subsection 2, an owner or operator of a facility for the management of hazardous waste who applies for an emergency permit pursuant to 40 C.F.R. § 270.61 shall, before the permit is issued by the Administrator, pay to the Division the following fees to offset the cost to process and review the application:

(a) A fee of \$25; and

(b) An additional fee of \$50 for each hour of staff time devoted to processing and reviewing the application.

2. The Administrator may waive the fees provided in subsection 1 for good cause shown.

(Added to NAC by Environmental Comm'n, eff. 5-27-92)

NAC 444.8448 Fees for modification, termination or reissuance of existing permit. ([NRS 459.485](#), [459.500](#), [459.520](#))

1. An owner or operator of a facility for the management of hazardous waste who applies for a modification or termination, or a revocation and reissuance, of an existing permit issued by the Division shall, before the Administrator may modify, terminate or reissue the existing permit, pay to the Division the following fees to offset the cost to process and review the application:

(a) A minimum fee of \$25; and

(b) An additional amount of \$50 for each hour of staff time devoted to processing and reviewing the application and the amount paid to consultants by the Division in connection with the application, not to exceed the maximum fee for an application pursuant to [NAC 444.8446](#).

2. If the facility contains more than one type of regulated unit, the operator is not required to pay more for each application than the maximum fee for the regulated unit to which the highest fee is applicable, unless the modification or termination, or revocation and reissuance, affect both a landfill and an incinerator. If the modification or termination, or revocation and reissuance, affect both a landfill and an incinerator, the operator is not required to pay more than \$100,000 for the application.

(Added to NAC by Environmental Comm'n, eff. 7-22-87; A 5-27-92)

NAC 444.845 Annual operating fee; penalty for unpaid fee. ([NRS 459.485](#), [459.500](#))

1. The owner or operator of a facility for the management of hazardous waste shall, on or before March 1 of each year, pay the following annual operating fee to the Division to offset partially the cost of inspection and other regulation of the facility:

Annual

Regulated Unit	Operating Fee
Landfills, incinerators, boilers, industrial furnaces.....	\$5,000
Surface impounds, facilities for treatment of land, facilities for thermal destruction.....	1,000
Tanks, portable containers, waste piles, facilities for treatment or storage..	500

2. If the facility contains more than one type of regulated unit, the operator is not required to pay more than the annual operating fee for the regulated unit to which the highest fee is applicable.

3. The Division may assess a penalty of 2 percent of the unpaid balance for each month, or portion thereof, that the fee remains unpaid.

4. As used in this section, “owner or operator of a facility for the management of hazardous waste” means a person who:

- (a) Qualifies for interim status pursuant to 40 C.F.R. Part 270, Subpart G; or
- (b) Has been issued a permit pursuant to 40 C.F.R. Part 124, Subparts A and B, and Part 270, Subparts A to F, inclusive.

(Added to NAC by Environmental Comm’n, eff. 7-22-87; A 5-27-92; 3-1-94)

NAC 444.8452 Additional fees to offset cost of inspection and other regulation: Payment; accounting; penalty for unpaid fee; waiver. ([NRS 459.485](#), [459.500](#), [459.510](#))

1. The owner or operator of a facility for the management of hazardous waste shall, in addition to any other applicable fees, pay the following fees to the Division to offset partially the cost of inspection and other regulation of the facility:

(a) For the disposal, open burn, open detonation or incineration of hazardous waste by a unit or for the burning of hazardous waste in a boiler or industrial furnace for the recovery of energy by a facility:

(1) Eighteen dollars and fifty cents per ton of the volume that is hazardous waste pursuant to paragraph (a) of subsection 2 of [NAC 444.843](#); and

(2) Three dollars per ton of the volume that is hazardous waste pursuant to paragraph (b) or (c) of subsection 2 of [NAC 444.843](#) but is not hazardous waste pursuant to paragraph (a) of that subsection.

(b) For the treatment or storage of a volume of hazardous waste by a unit without:

(1) Subsequent disposal, open burn, open detonation or incineration of the hazardous waste by the facility; or

(2) Subsequent burning of the hazardous waste in a boiler or industrial furnace for the recovery of energy by the facility,

É \$5 per ton, not to exceed a maximum fee of \$10,000 per calendar year if the waste that is stored or treated is waste generated at that facility.

(c) For the treatment of a volume of hazardous waste by a unit so that it is no longer hazardous waste pursuant to [NAC 444.843](#) and subsequent disposal of the treated waste by the facility, \$3 per ton.

2. The owner or operator of such a facility shall:

(a) Calculate the amount of hazardous waste subject to the fees on a quarterly basis based on the volume of the hazardous waste that is newly managed by a unit during the quarter of the year for which the fees are calculated;

(b) Pay the fees provided in this section within 30 days after the end of each quarter; and

(c) Submit, with each payment, a detailed accounting of the volume of waste, which corresponds to the fee paid.

3. The Division may assess a penalty of 2 percent of the unpaid balance for each month, or portion thereof, that a fee remains unpaid.

4. The Division may waive any part of the fees specified in subsection 1 for waste brought to a state-owned facility if the waste is generated:

- (a) By an agency of this State; or
- (b) In compliance with an order issued by the Division to clean up a spill or deposit.

5. As used in this section:

(a) "Owner or operator of a facility for the management of hazardous waste" means a person who:

- (1) Qualifies for interim status pursuant to 40 C.F.R. Part 270, Subpart G; or
- (2) Has been issued a permit pursuant to 40 C.F.R. Part 124, Subparts A and B, and Part 270, Subparts

A to F, inclusive.

(b) "Unit" means a unit for the management of hazardous waste that is:

- (1) Operated by a facility for the management of hazardous waste; and
- (2) Subject to the permitting requirements of 40 C.F.R. Part 270.

(Added to NAC by Environmental Comm'n, eff. 7-22-87; A 5-27-92; 3-1-94; R107-97, 3-5-98; R170-99, 1-26-2000)

NAC 444.8454 Deposit of fees. ([NRS 459.485](#), [459.500](#), [459.510](#)) The Division shall deposit the fees and penalties it collects pursuant to [NAC 444.8446](#) to [444.8452](#), inclusive, with the State Treasurer for credit to the Account for the Management of Hazardous Waste.

(Added to NAC by Environmental Comm'n, eff. 7-22-87; A by R170-99, 1-26-2000)

NAC 444.8455 Facility or mobile unit for recycling of hazardous waste: Preliminary requirements; exemption. ([NRS 459.485](#))

1. Except as otherwise provided in subsection 4, a person who proposes to construct or operate a facility for the recycling of hazardous waste must obtain a written determination from the Administrator that the facility will operate as a facility for the recycling of hazardous waste before commencing the construction or operation of the facility. If the facility will recycle hazardous waste other than used antifreeze governed by [NAC 444.8801](#) to [444.9071](#), inclusive, or precious metals governed by 40 C.F.R. Part 266, the Administrator must approve an operating plan for the facility before construction or operation of the facility commences. Such an operating plan must, without limitation, include a description of the procedures that will ensure safe operation and demonstrate compliance with:

(a) The requirements for emergency preparedness and a contingency plan specified in 40 C.F.R. Part 264, Subparts C and D;

(b) The standards for containers and tanks specified in 40 C.F.R. Part 264, Subparts I, J, AA, BB and CC; and

(c) The applicable requirements for closure and financial assurance for closure specified in 40 C.F.R. Part 264, Subparts G and H.

2. Except as otherwise provided in subsection 4, a person who proposes to construct or operate a mobile unit for the recycling of hazardous waste must obtain a written determination from the Administrator that the mobile unit will operate as a mobile unit for the recycling of hazardous waste before commencing the construction or operation of the mobile unit.

3. A written determination required pursuant to subsection 1 or 2 may be requested by filing a written application with the Administrator.

4. The provisions of this section do not apply to a person who is recycling hazardous waste which he or she has generated, at a unit for the recycling of hazardous waste which is owned by the person and is located at the same site at which the hazardous waste is generated.

(Added to NAC by Environmental Comm'n, eff. 4-18-90; A 3-1-94; R104-02, 10-18-2002)

NAC 444.84555 Facility or mobile unit for recycling of hazardous waste: Written determination by Administrator. ([NRS 459.485](#))

1. An application for a written determination that a proposed facility or mobile unit will operate as a facility for the recycling of hazardous waste or mobile unit for the recycling of hazardous waste must be accompanied by:

(a) The name and address of the owner and operator of the facility or mobile unit;

(b) The name and address of the property owner of the location at which a facility is proposed to be constructed;

- (c) A detailed description of the type of recycling which is proposed, including:
- (1) The manufacturer of the equipment to be used at the facility or mobile unit;
 - (2) The nature of the recycling; and
 - (3) An explanation evidencing that the:
 - (I) Facility is a facility for the recycling of hazardous waste; or
 - (II) Mobile unit is a mobile unit for the recycling of hazardous waste;
- (d) A description of the source and estimated amount of hazardous waste to be recycled on an average day and on a peak day;
- (e) A physical and chemical description of the type of hazardous waste to be accepted by the facility or processed by the mobile unit;
- (f) A detailed economic analysis of the recycling process to be used at the facility or by the mobile unit, including:
- (1) The projected costs to operate the facility or mobile unit;
 - (2) The fees that would be charged per unit of volume to process waste transported to the facility or processed by the mobile unit;
 - (3) The projected value that would be recovered per unit of volume; and
 - (4) The projected costs otherwise to manage, recycle, treat or dispose of the material as a hazardous waste;
- (g) A description of the markets and the uses for the products to be produced and the materials and energy to be recovered;
- (h) A comparison of the economic and environmental impact of the proposed recycling process to a process which uses material that is not considered waste when producing the same product; and
- (i) An operating plan if the facility is a stationary facility and will recycle hazardous waste other than used antifreeze governed by [NAC 444.8801](#) to [444.9071](#), inclusive, or precious metals governed by 40 C.F.R. Part 266. Such an operating plan must, without limitation, include a description of the procedures that will ensure safe operation and demonstrate compliance with:
- (1) The requirements for emergency preparedness and a contingency plan specified in 40 C.F.R. Part 264, Subparts C and D;
 - (2) The standards for containers and tanks specified in 40 C.F.R. Part 264, Subparts I, J, AA, BB and CC; and
 - (3) The applicable requirements for closure and financial assurance for closure specified in 40 C.F.R. Part 264, Subparts G and H.
2. The Administrator may require the applicant to submit additional information before issuing a written determination.
3. The Administrator shall not issue a written determination unless he or she determines, based upon the application, that all the following requirements are satisfied:
- (a) The facility or mobile unit will be operated as a facility or mobile unit for the recycling of hazardous waste.
 - (b) The recycling process has economic value. A recycling process has economic value if:
 - (1) The applicant shows that the material recovered from or the products or energy produced as a result of the process have value in the marketplace; and
 - (2) The fees that the applicant charges per unit of volume to process the material are less than or equal to the cost otherwise to recycle, manage, treat or dispose of the material as a hazardous waste, except that the fees that the applicant charges per unit of volume may be offset by the recovered unit value of the material recovered from or the products or energy produced as a result of the process.
 - (c) The probable beneficial environmental effect of the facility or mobile unit to the State outweighs the probable adverse environmental effect.
4. Before issuing a written determination for a facility, the Administrator shall provide for a period of public notice and comment of not less than 45 days. The request for public comment must be noticed in a local newspaper of general circulation that is published daily or weekly and must be sent to all persons on a mailing list developed and maintained by the Administrator. A person may request to be placed on the mailing list by contacting the Administrator. The Administrator shall respond to all comments he or she receives during the period provided for comments before making his or her determination to issue or not to

issue a written determination.

5. The Administrator may revoke, suspend or modify a written determination if, at any time, he or she determines that:

- (a) A facility or mobile unit no longer satisfies the conditions stated in the application upon which the Administrator issued the written determination;
- (b) An applicant misrepresented or failed to disclose fully a relevant fact on his or her application;
- (c) The Administrator receives information that was not available at the time the Administrator issued the written determination which would have justified the imposition of different conditions at the time the determination was issued; or
- (d) The standards or regulations on which the Administrator based the written determination have been changed.

6. A person may request a hearing before the Commission concerning a final decision of the Administrator to issue, deny, revoke, suspend or modify a written determination by filing a request, not more than 10 days after receiving notice from the Administrator of his or her decision, on Form 3 with the State Environmental Commission, Bryan State Office Building, 901 South Stewart Street, Carson City, Nevada 89701-5249. The provisions of [NAC 445B.875](#) to [445B.899](#), inclusive, apply to a hearing of the Commission requested pursuant to this section.

(Added to NAC by Environmental Comm'n, eff. 4-18-90; A 3-1-94; R125-98, 11-2-98; R104-02, 10-18-2002; R015-08, 4-17-2008)

NAC 444.8456 Stationary new or expanding facility for management of hazardous waste: Restrictions on location; exempt facilities. ([NRS 459.485](#))

1. A stationary new or expanding facility for the management of hazardous waste must not be constructed within:

- (a) One mile of:
 - (1) A dwelling, school, church or community center;
 - (2) An area zoned solely for residential use;
 - (3) A public park;
 - (4) A wildlife management area;
 - (5) An area identified by the Department of Wildlife as a key habitat for wildlife or as a habitat for an endangered or threatened species;
 - (6) An area where surface water or wetlands occur;
 - (7) A natural or artificially created geologic hazard which provides a potential for the conveyance of hazardous constituents, as that term is defined in Appendix VIII of 40 C.F.R. Part 261, to surface or groundwaters; or
 - (8) An existing well which supplies public drinking water;

(b) An area identified by the Office of Historic Preservation of the State Department of Conservation and Natural Resources as an historical or archeological site that is eligible for listing in the State Register of Historic Places or the National Register of Historic Places, unless an approved mitigation activity has been completed on the site;

- (c) A 100-year floodplain; or
- (d) An area where the water table seasonally rises to within 150 feet of the surface of the ground.

2. The provisions of this section do not apply to a facility:

- (a) For community recycling;
- (b) For community storage;
- (c) For the storage of hazardous waste which is generated on the site of the facility; or
- (d) Which qualifies for interim status pursuant to 40 C.F.R. Part 270, Subpart G.

(Added to NAC by Environmental Comm'n, eff. 7-22-87; A 4-18-90; 3-1-94; R104-02, 10-18-2002)

NAC 444.8458 Stationary new or expanding facility for management of hazardous waste: Certificate of designation; prerequisite for permit; application; issuance; exempt facilities. ([NRS 459.485](#), [459.520](#))

1. A person who proposes to construct or operate a new or new or expanding facility for the

management of hazardous waste must obtain a certificate of designation from the Administrator before the submission of an application for a permit or class 3 modification required pursuant to 40 C.F.R. Part 124, Subparts A and B, and Part 270, Subparts A to F, inclusive.

2. An application for a certificate of designation must be accompanied by sufficient information to determine the need for the facility and by information concerning:

(a) The effect of the proposed facility on the public health, safety and welfare in the geographic area and any municipality near its proposed location, including without limitation:

(1) The risk and effect of an accident in the transportation of hazardous waste to the facility;

(2) The identification, risk and effect of any spill, discharge, fire, failure of equipment or other emergency that could occur at the facility;

(3) The identification, risk and effect of any exposure to persons of hazardous waste, or products of the degradation of hazardous waste, that could occur during the operation or after the closure of the facility;

(4) The consistency of the facility with local and regional plans and regulations for the use of land;

(5) The protection of the public from adverse effects, including the economic and environmental effects from the construction and operation, and care after closure, of the facility;

(6) The risk and effect of the facility concerning public and private sources of drinking water; and

(7) The risk and effect of the facility concerning scenic, historic and recreational areas, and wetlands, floodplains, wildlife areas and other areas that are environmentally sensitive;

(b) The density of population in the proximity of the proposed location for the facility;

(c) The public benefits of the proposed facility, including:

(1) The need in the State for the additional capacity for the management of hazardous waste;

(2) The energy and resources recoverable by the proposed facility; and

(3) The reduction in methods for the management of hazardous waste, which are less suitable for the environment, that would be made possible by the proposed facility;

(d) Whether any other available site or method for the management of hazardous waste would be less detrimental to the public health or safety or to the quality of the environment;

(e) The applicant's qualifications and experience in the management of hazardous waste;

(f) Whether the proposed facility complies with the provisions of [NAC 444.8456](#); and

(g) The characteristics, sources and quantity of hazardous waste to be managed.

3. The Administrator shall not issue a certificate of designation unless he or she determines, based upon the application, that:

(a) The probable beneficial environmental effect of the facility to the State outweighs the probable adverse environmental effect; and

(b) There is a need for the facility to serve industry in the State. The Administrator shall set forth in writing the basis of his or her determination of need for the facility.

4. The provisions of this section do not apply to a facility:

(a) For community recycling;

(b) For community storage;

(c) For the storage of hazardous waste which is generated on the site of the facility; or

(d) Which qualifies for interim status pursuant to 40 C.F.R. Part 270, Subpart G.

(Added to NAC by Environmental Comm'n, eff. 7-22-87; A 4-18-90; 3-1-94; 9-15-94)

NAC 444.846 Fee for volume of hazardous waste received by facility for the management of hazardous waste owned by State: Amount; payment; penalty; disposition. ([NRS 459.485](#), [459.510](#))

1. The operator of a facility for the management of hazardous waste that is owned by the State of Nevada shall, in addition to any other applicable fees, pay to the Division of Environmental Protection of the State Department of Conservation and Natural Resources a fee of 25 cents per cubic foot of the volume of all hazardous waste received at the facility.

2. The operator of such a facility shall pay the fee provided in subsection 1, based upon the volume of hazardous waste received by the facility during each quarter of the calendar year, within 30 days after the end of each quarter.

3. The Division of Environmental Protection may assess and collect a penalty of 2 percent of the unpaid balance for each month, or portion thereof, that the fee remains due.

4. The Division of Environmental Protection shall:

- (a) Deposit the money received pursuant to this section in the Account for the Management of Hazardous Waste created pursuant to [NRS 459.530](#);
 - (b) Account for the money received pursuant to this section separately; and
 - (c) Use the money for the cost of closure and perpetual care of the facility.
- (Added to NAC by Environmental Comm'n, eff. 1-2-92; A by R170-99, 1-26-2000)

Variances

NAC 444.847 Submission of application. ([NRS 459.485](#), [459.548](#)) Any person seeking a variance from the provisions of [NAC 444.842](#) to [444.8482](#), inclusive, must submit an application for the variance to the Secretary of the Commission.

(Added to NAC by Environmental Comm'n, eff. 4-18-90)

NAC 444.8472 Contents of application. ([NRS 459.485](#), [459.548](#)) An application for a variance must:

1. Be accompanied by:
 - (a) The maximum fee prescribed by subsection 2 of [NAC 444.8474](#);
 - (b) A map showing:
 - (1) The site of the facility or proposed facility; and
 - (2) The location of any area, structure, park, hazard or well described in [NAC 444.8456](#) and located within 2 miles of the facility;
 - (c) Any drawings, plans or specifications related to the variance requested; and
 - (d) If it has not previously been submitted, any report of operations required to be submitted to the Division pursuant to this chapter.
 2. Include:
 - (a) The name and address of the applicant;
 - (b) A detailed description of the regulated activity in which the applicant is engaged or in which he or she wishes to engage;
 - (c) A detailed description of the variance requested;
 - (d) A statement of the reasons for seeking the variance;
 - (e) A detailed analysis of the environmental effects of the facility or proposed facility under the worst expected adverse conditions if the variance is granted;
 - (f) A description of the extent to which the facility or proposed facility will affect the local environment and the public health under the worst expected adverse conditions if the variance is granted;
 - (g) A description of any:
 - (1) Hardship to the applicant; and
 - (2) Benefit to the environment and public health,
- Ê that will result from denial of the variance;
- (h) In the case of an application relating to an existing facility, a detailed description of any prior judicial or administrative proceeding affecting the facility, with a description of any corrective action taken as a result of the proceeding; and
 - (i) A detailed description of any prior judicial or administrative proceeding involving:
 - (1) The applicant or any officer, partner or coadventurer of the applicant; and
 - (2) The operation of a facility for the management of hazardous waste,
- Ê with a description of any corrective action taken as a result of the proceeding.
- (Added to NAC by Environmental Comm'n, eff. 4-18-90)

NAC 444.8474 Fee for review of application: Amount; return of excess. ([NRS 459.485](#), [459.548](#))

1. An applicant for a variance shall pay:
 - (a) A fee of \$50 per hour for each hour spent by the staff of the Division to review the application; and
 - (b) The actual cost of travel, per diem, salaries and any other expenses incurred by the Commission in connection with the application.
2. The amount to be paid by an applicant pursuant to subsection 1 will not exceed:

(a) Five thousand dollars in the case of a facility or proposed facility handling less than 1,000 tons of waste annually.

(b) Ten thousand dollars in the case of a facility or proposed facility handling 1,000 tons or more but less than 10,000 tons of waste annually.

(c) Twenty thousand dollars in the case of a facility or proposed facility of unspecified capacity or handling 10,000 tons or more of hazardous waste annually.

3. The Division shall maintain an accurate account of the time and expense associated with the review of each application and, upon completion of the review, refund to the applicant any difference between the amount required to cover the cost of the review and the amount paid at the time the application was filed.

(Added to NAC by Environmental Comm'n, eff. 4-18-90)

NAC 444.8476 Initial review of application; recommendation to Commission. ([NRS 459.485](#), [459.548](#)) Upon the filing of an application for a variance, the Division shall review the application and accompanying materials and make a recommendation to the Commission for approval or disapproval of the application.

(Added to NAC by Environmental Comm'n, eff. 4-18-90)

NAC 444.8478 Public comment and hearing on application; statement of reasons for denial. ([NRS 459.485](#), [459.548](#))

1. Before an application is heard, the Commission will provide for a period of public notice and comment of not less than 30 days. After the expiration of that period, the application will be heard by the Commission at its next regularly scheduled meeting or at a meeting scheduled by the Chair of the Commission.

2. If the Commission denies an application, it will state its reasons for the denial.

(Added to NAC by Environmental Comm'n, eff. 4-18-90)

NAC 444.848 Duration of variance; revocation; annual review. ([NRS 459.485](#), [459.546](#), [459.548](#))

1. The duration of a variance will be established by the Commission in each case, but in no event does a variance continue in force after the expiration of any permit issued by the Division for the facility involved.

2. A variance may be revoked by the Commission if it finds, after notice to the owner or operator of the facility and a hearing at which the owner or operator is given an opportunity to be heard:

(a) That the owner or operator has violated any condition of the variance; or

(b) That continued operation of the facility as permitted by the variance poses an unreasonable threat to the public health or violates minimum requirements for the protection of public health as established by state and federal laws and regulations.

3. The Commission will review each variance at least once each year to ensure continuing compliance with the conditions of the variance.

(Added to NAC by Environmental Comm'n, eff. 4-18-90)

NAC 444.8482 Renewal of variance. ([NRS 459.485](#), [459.547](#), [459.548](#))

1. A variance must be renewed before the renewal of any permit issued by the Division for the facility involved.

2. An application to renew a variance is subject to all the provisions of [NAC 444.847](#) to [444.8482](#), inclusive, except that the information required by [NAC 444.8472](#) for an original application need not be submitted if the applicant requests the incorporation into the present record of the entire administrative record relating to the original application.

(Added to NAC by Environmental Comm'n, eff. 4-18-90)

DISPOSAL OF HAZARDOUS WASTE

General Provisions

NAC 444.850 Definitions. ([NRS 459.485](#)) As used in [NAC 444.850](#) to [444.8746](#), inclusive, unless the

context otherwise requires:

1. The words and terms defined in [NAC 444.8505](#) to [444.861](#), inclusive, have the meanings ascribed to them in those sections.

2. Except for the words and terms otherwise defined in [NAC 444.8505](#) to [444.861](#), inclusive, the words and terms defined in 40 C.F.R. § 260.10, as that section existed on July 1, 2008, have the meanings ascribed to them in that section.

(Added to NAC by Environmental Comm'n, eff. 11-22-82; A 9-19-90; 9-19-90, eff. 12-1-90; 1-2-92; 5-27-92; 5-27-92; 10-29-93; 3-1-94; 11-9-95; R202-97, 3-5-98; R124-98, 11-2-98; R170-99, 1-26-2000; R037-01, 10-25-2001; R104-02, 10-18-2002; R126-03, 4-13-2004; R175-05, 5-4-2006; R137-07, 1-30-2008; R015-08, 4-17-2008; R153-08, 4-23-2009)

NAC 444.8505 “Administrator” defined. ([NRS 459.485](#)) “Administrator” means the Regional Administrator of the United States Environmental Protection Agency.

(Added to NAC by Environmental Comm'n, eff. 11-22-82)

NAC 444.8508 “Commission” defined. ([NRS 459.485](#)) “Commission” means the State Environmental Commission.

(Added to NAC by Environmental Comm'n, eff. 5-27-92)

NAC 444.8509 “Conditionally exempt small quantity generator” defined. ([NRS 459.485](#)) “Conditionally exempt small quantity generator” means a generator which generates 100 kilograms of hazardous waste or less in a calendar month. A generator is a conditionally exempt small quantity generator only during the calendar months that it generates 100 kilograms of hazardous waste or less.

(Added to NAC by Environmental Comm'n, eff. 3-1-94)

NAC 444.851 “Department” defined. ([NRS 459.485](#)) “Department” means the State Department of Conservation and Natural Resources.

(Added to NAC by Environmental Comm'n, eff. 11-22-82)

NAC 444.8515 “Director” defined. ([NRS 459.485](#)) “Director” means the Director of the Department.

(Added to NAC by Environmental Comm'n, eff. 11-22-82)

NAC 444.853 “Division” defined. ([NRS 459.485](#)) “Division” means the Division of Environmental Protection.

(Added to NAC by Environmental Comm'n, eff. 11-22-82)

NAC 444.8546 “Facility for the management of hazardous waste” defined. ([NRS 459.485](#)) “Facility for the management of hazardous waste” has the meaning ascribed to it in [NAC 444.8428](#).

(Added to NAC by Environmental Comm'n, eff. 5-27-92)

NAC 444.8565 “Hazardous waste” defined. ([NRS 459.485](#))

1. “Hazardous waste” has the meaning ascribed to it in [NRS 459.430](#).

2. The term includes any:

(a) Hazardous waste or constituent of hazardous waste which is subject to regulation under 40 C.F.R. Part 261; and

(b) Waste brought into this State which is designated as hazardous waste in the state of its origin.

Ê The term does not include waste containing polychlorinated biphenyl, unless it is mixed with hazardous waste.

(Added to NAC by Environmental Comm'n, eff. 11-22-82; A 10-3-83; 6-29-84; 10-16-85; 7-22-87; 7-1-88; 9-19-90; R202-97, 3-5-98)

NAC 444.861 “Used oil” defined. ([NRS 459.485](#)) “Used oil” means any oil that has been refined from crude oil, or any synthetic oil, that has been used and as a result of the use is contaminated by physical or chemical impurities.

(Added to NAC by Environmental Comm’n, eff. 3-1-94)

NAC 444.8618 Information concerning and application for EPA identification number. ([NRS 459.485](#)) A generator, transporter or facility owner or operator who is required to obtain an EPA identification number pursuant to 40 C.F.R. § 262.12, 263.11, 264.1(j)(1), 264.11 or 265.11 may obtain information relating to the procedure to obtain the identification number and an application by submitting a request in writing to the Division of Environmental Protection, Bryan State Office Building, 901 South Stewart Street, Carson City, Nevada 89701-5249, or by telephone at (775) 687-9481.

(Added to NAC by Environmental Comm’n by R019-00, eff. 5-26-2000; A by R126-03, 4-13-2004; R175-05, 5-4-2006)

Standards of Practice

NAC 444.8632 Compliance with federal regulations adopted by reference. ([NRS 459.485](#))

1. In addition to the requirements of [NAC 444.850](#) to [444.8746](#), inclusive, a person who generates, transports, treats, stores, disposes or otherwise manages hazardous waste or used oil shall comply with all applicable requirements of, and may rely upon applicable exclusions or exemptions under, 40 C.F.R. Part 2, Subpart A, Part 124, Subparts A and B, Parts 260 to 270, inclusive, Part 273 and Part 279, as those provisions existed on July 1, 2008, which, except as otherwise modified by [NAC 444.86325](#), [444.8633](#) and [444.8634](#), are hereby adopted by reference. The Commission may use federal statutes and regulations that are cited in 40 C.F.R. Part 2, Subpart A, Part 124, Subparts A and B, Parts 260 to 270, inclusive, Part 273 and Part 279 to interpret those sections and parts.

2. The volumes containing those parts may be obtained by mail from the Superintendent of Documents, U.S. Government Printing Office, P.O. Box 979050, St. Louis, Missouri 63197-9000, or by toll-free telephone at (866) 512-1800, for the following prices:

(a) Volume 40 C.F.R. Parts 1 to 49, inclusive.....	\$60
(b) Volume 40 C.F.R. Parts 100 to 135, inclusive.....	48
(c) Volume 40 C.F.R. Parts 260 to 265, inclusive.....	53
(d) Volume 40 C.F.R. Parts 266 to 299, inclusive.....	50

(Added to NAC by Environmental Comm’n, eff. 7-22-87; A 3-7-90; 9-19-90; 1-2-92; 5-27-92; 10-29-93; 3-1-94; 9-15-94; 11-9-95; R202-97, 3-5-98; R124-98, 11-2-98; R170-99, 1-26-2000; R037-01, 10-25-2001; R104-02, 10-18-2002; R126-03, 4-13-2004; R175-05, 5-4-2006; R137-07, 1-30-2008; R015-08, 4-17-2008; R153-08, 4-23-2009)

NAC 444.86325 Exceptions to and revision of federal regulations adopted by reference. ([NRS 459.485](#))

1. The following sections and parts of Title 40 of the Code of Federal Regulations, and any reference to those sections and parts, are not adopted by reference:

- (a) Section 2.101(a)(1)-(10);
- (b) Sections 124.1(b)-(e), 124.4, 124.5(e), 124.9, 124.10(a)(1)(iv), 124.15(b)(2), 124.16, 124.17(b), 124.18, 124.19 and 124.21;
- (c) Sections 260.1(b)(4)-(6) and 260.20, 260.21 and 260.22;
- (d) Section 261.5(j);
- (e) Part 262, Subpart H;
- (f) Sections 264.1(d), 264.1(f), 264.149, 264.150, 264.301(1), 264.1050(h), 265.1(c)(4), 265.149, 265.150, 265.430 and 265.1050(g);
- (g) Section 266.111;
- (h) Sections 268.5 and 268.6, Part 268, Subpart B, and sections 268.42(b) and 268.44;
- (i) Sections 270.1(c)(1)(i), 270.60(b) and 270.64;

- (j) Part 278; and
- (k) Sections 279.10(b)(2), 279.10(b)(3), 279.10(c), 279.10(d)(1), 279.42(b)(2), 279.51(b)(2), 279.62(b)(2) and 279.73(b)(2).

2. The following parts and sections of Title 40 of the Code of Federal Regulations are adopted by reference, as revised in this subsection:

- (a) Part 124 is adopted with the following exceptions:
 - (1) Delete all references to appeals to the Administrator in section 124.5(b);
 - (2) Delete all references to "EPA-issued permits" and insert in its place "permits issued by the Department," except in sections 124.5(d), 124.10(b) and 124.10(d)(1)(vi);
 - (3) Delete all references to "when EPA is the permitting issuing authority" and insert in its place "when the Department is authorized to issue a permit," except in sections 124.5(d), 124.10(b) and 124.10(d)(1)(vi);
 - (4) Subpart A is adopted solely for the purpose of establishing procedures for permits for the management of hazardous waste, except that all references to "UIC," "PSD" and "NPDES" are deleted;
 - (5) Delete all references to "RCRA part B," "part B RCRA" and "part B" and insert in their place "[NRS 459.400](#) to [459.600](#), inclusive," in sections 124.31 and 124.32; and
 - (6) Delete from sections 124.31(a), 124.32(a) and 124.33(a) the following sentence: "For the purposes of this section only, 'hazardous waste management units over which EPA has permit issuance authority' refers to hazardous waste management units for which the State where the units are located has not been authorized to issue RCRA permits pursuant to 40 C.F.R. part 271."
 - (b) Section 260.2(a) is adopted except that the Freedom of Information Act, 5 U.S.C. § 552, section 3007(b) of RCRA and EPA regulations implementing the Freedom of Information Act and section 3007(b) must be replaced with "[NRS 459.555](#) and any regulations adopted pursuant thereto."
 - (c) Section 260.11(a) is adopted except that "and 278" is deleted.
 - (d) Section 260.11(c)(3)(vii) is adopted except that "and § 278.3(b)(1)" is deleted.
 - (e) Section 260.33(b) is adopted except that "in the locality where the recycler is located" is deleted.
 - (f) Section 260.41(a) is adopted except that "or unless review by the Administrator is requested. The order may be appealed to the Administrator by any person who participated in the public hearing. The Administrator may choose to grant or to deny the appeal" is deleted.
 - (g) Section 261.4(e)(3)(iii) is adopted except that "in the Region where the sample is collected" is deleted.
 - (h) Section 262.11(c)(1) is adopted except that "; or according to an equivalent method approved by the Administrator under 40 C.F.R. Part 260.21" is deleted.
 - (i) Sections 262.42(a)(2) and 262.42(b) are adopted except that "for the Region in which the generator is located" is deleted.
 - (j) Sections 264.18(c) and 265.18 are adopted except that "except for the Department of Energy Waste Isolation Pilot Project in New Mexico" is deleted.
 - (k) Sections 264.143(h), 264.145(h), 265.143(g) and 265.145(g) are adopted except that "If the facilities covered by the mechanism are in more than one Region, identical evidence of financial assurance must be submitted to and maintained with the Regional Administrators of all such Regions" is deleted.
 - (l) Sections 264.147(a)(1)(i), 264.147(b)(1)(i) and 265.147(a)(1)(i) are adopted except that "or Regional Administrators if the facilities are located in more than one Region" is deleted.
 - (m) Section 264.151 is adopted with the following exceptions:
 - (1) Delete all references to "(of/for) the Regions in which the facilities are located"; and
 - (2) Delete "an agency of the United States Government" from the second paragraph of the trust agreement.
 - (n) Part 270 is adopted except that all references to "interim authorization" are deleted.
 - (o) Section 279.40(c) is adopted except that "unless, under the provisions of § 279.10(b), the hazardous waste/used oil mixture is determined not to be hazardous waste" is deleted.
- (Added to NAC by Environmental Comm'n, eff. 1-2-92; A 10-29-93; 3-1-94; R202-97, 3-5-98; R037-01, 10-25-2001; R104-02, 10-18-2002; R175-05, 5-4-2006; R153-08, 4-23-2009)

NAC 444.8633 Revision of certain terms referred to in federal regulations adopted by reference.
([NRS 459.485](#)) Except as otherwise provided in [NAC 444.8634](#):

1. Any references in any part of Title 40 of the Code of Federal Regulations to the U.S. Environmental Protection Agency, "United States Environmental Protection Agency," "Agency," "EPA Headquarters," "EPA Region(s)" or "EPA" which have been adopted by reference shall be deemed to mean the "Department" with the following exceptions:

- (a) Any reference to "EPA" identification numbers;
- (b) Any reference to "EPA" hazardous waste numbers;
- (c) Any reference to "EPA" test methods;
- (d) Any reference to "EPA" forms;
- (e) Any reference to "EPA" publications or manuals;
- (f) Any reference to "EPA" guidance;
- (g) Any reference to "EPA" Acknowledgment of Consent;
- (h) Any reference to "EPA" or "Agency" in:
 - (1) Sections 124.1(f), 124.2(b), 124.6(e) and 124.10(c)(1)(ii);
 - (2) The provisions of section 124.2(a) defining "Administrator," "Director," "EPA," "permit," "person" and "Regional Administrator";
 - (3) The provisions of section 260.10 defining "Administrator," "EPA Region," "federal agency," "person" and "Regional Administrator";
 - (4) Part 260, Appendix I;
 - (5) Section 261.39(a)(5) and Part 261, Appendix IX;
 - (6) Section 262.32(b), Part 262, Subparts E and F, and the Appendix to Part 262;
 - (7) The Note following section 263.10(a);
 - (8) Sections 264.11, 264.71, 265.11 and 265.71;
 - (9) Section 268.1(e)(3);
 - (10) Sections 270.1(a)(1), 270.1(b), 270.3, 270.5, 270.10(e)(1)-(2), 270.11(a)(3), 270.32(a), 270.32(c), 270.51, 270.72(a)(5) and 270.72(b)(5); and
 - (11) The provisions of section 270.2 defining "Administrator," "approved program or approved State," "Director," "Environmental Protection Agency," "EPA," "final authorization," "permit," "person," "Regional Administrator" and "state/EPA agreement"; and
- (i) Any reference to "EPA," "Agency" or "EPA Director of the Office of Solid Waste" in section 262.21 and any subsequent reference to EPA's oversight of the manifest registry process in Part 262, Subparts C and E.

2. Any references in any part of Title 40 of the Code of Federal Regulations to the "Regional Administrator" or "Administrator" which have been adopted by reference shall be deemed to mean the "Director" with the following exceptions:

- (a) The provisions of section 124.2(a) defining "Administrator," "Director," "interstate agency," "major facility" and "Regional Administrator";
- (b) Sections 124.2(b), 124.5(d), 124.6(e) and 124.10(b);
- (c) The provisions of section 260.10 defining "Administrator," "Regional Administrator" and "hazardous waste constituent";
- (d) Section 261.30(b), Section 261.4 and Part 261, Appendix IX;
- (e) Section 262.12, Part 262, Subpart E and the Appendix to Part 262;
- (f) Sections 263.11 and 264.1(j)(1);
- (g) Sections 264.12(a) and 265.12(a);
- (h) The provisions of section 270.2 defining "Administrator," "Director," "major facility," "Regional Administrator" and "state/EPA agreement"; and
- (i) Sections 270.3, 270.5, 270.10(e)(1)-(2), 270.10(e)(4), 270.10(f)-(g), 270.11(a)(3), 270.14(b)(20), 270.32(b)(2) and 270.51.

3. Any references in any part of Title 40 of the Code of Federal Regulations to the Resource Conservation and Recovery Act, "RCRA," "Subtitle C of RCRA," "RCRA Subtitle C" or "Subtitle C" which have been adopted by reference shall be deemed to mean "[NRS 459.400](#) to [459.600](#), inclusive," when referring to an operating permit or to the federal hazardous waste program, with the following exceptions:

- (a) Any references to a specific provision of the Resource Conservation and Recovery Act, "RCRA," "Subtitle C of RCRA," "RCRA Subtitle C" or "Subtitle C";

- (b) The provisions of section 124.2 defining “appropriate act and regulations” and “RCRA”;
- (c) The provisions of section 260.10 defining “Act or RCRA”;
- (d) Part 260, Appendix I;
- (e) Part 261, Appendix IX;
- (f) The Appendix to Part 262;
- (g) Section 270.1(a)(2); and
- (h) The provisions of section 270.2 defining “RCRA” and the provision of section 270.51 defining “RCRA permit.”

4. Following any references in any part of Title 40 of the Code of Federal Regulations to a specific provision of the Resource Conservation and Recovery Act, “RCRA,” “Subtitle C of RCRA,” “RCRA Subtitle C” or “Subtitle C,” which have been adopted by reference, the phrase “or any comparable provisions of [NRS 459.400](#) to [459.600](#), inclusive, and any regulations adopted pursuant thereto” shall be deemed to be added with the following exceptions:

- (a) Section 270.1(a)(2);
- (b) Section 270.72(a)(5); and
- (c) Section 270.72(b)(5).

5. Any references in any part of Title 40 of the Code of Federal Regulations to the “Department of Transportation” or “DOT” which have been adopted by reference shall be deemed to mean “the Department of Transportation of the United States.”

6. Any references in any part of Title 40 of the Code of Federal Regulations to “state(s),” “authorized state,” “approved state” or “approved program” which have been adopted by reference shall be deemed to mean “Nevada” with the following exceptions:

- (a) The provisions of section 124.2(a) defining “Director,” “interstate agency,” “person” and “state”;
- (b) The provisions of section 260.10 defining “person,” “state” and “United States”;
- (c) Part 262;
- (d) Sections 264.143(e)(1), 264.145(e)(1), 264.147(a)(1)(ii), 264.147(b)(1)(ii), 264.147(g)(2) and 264.147(i)(4);
- (e) Sections 265.143(d)(1), 265.145(d)(1), 265.147(a)(1)(ii), 265.147(g)(2) and 265.147(i)(4); and
- (f) The provisions of section 270.2 defining “approved program or approved State,” “Director,” “final authorization,” “person” and “state.”

(Added to NAC by Environmental Comm’n, eff. 6-29-84; A 7-22-87; 9-19-90; 1-2-92; 10-29-93; R019-00, 5-26-2000; R175-05, 5-4-2006; R015-08, 4-17-2008)

NAC 444.8634 Meanings ascribed to certain terms referred to in federal regulations; payment and deposit of certain fees. ([NRS 459.485](#))

1. Any reference to the following terms in 40 C.F.R. Part 2, Subpart A, shall be deemed to have the meanings ascribed thereto in this section:

- (a) “District court of the United States” or “Federal district court” shall be deemed to mean “district court in Nevada”;
- (b) “Federal agency” shall be deemed to mean “state agency”;
- (c) Except in section 2.105(a), Freedom of Information Act, “FOIA,” the “Act” or “5 U.S.C. 552” shall be deemed to mean “[NRS 459.555](#) and any regulations adopted pursuant thereto”;
- (d) “Freedom of information officer” shall be deemed to mean the “Administrator of the Division or his or her designee”;
- (e) “General counsel” shall be deemed to mean the “Attorney General of Nevada”;
- (f) Any addresses shall be deemed to mean the “Division of Environmental Protection, Bryan State Office Building, 901 South Stewart Street, Carson City, Nevada 89701-5249”;
- (g) Any references to the employment rankings of “GS-8” or “GS-9” shall be deemed to mean, respectively, “grade 31” and “grade 32” of the Nevada Personnel System established pursuant to [NRS 284.170](#), and any reference to a fee for the cost of staff time shall be deemed to mean, respectively, \$15 and \$22.50 per half hour;
- (h) Any references to duplication or reproduction charges of “\$0.15 per page” shall be deemed to mean “10 cents per page”; and

(i) Any reference to an officer except the general counsel shall be deemed to mean the “Administrator of the Division.”

2. Any reference to the “Administrator” in 40 C.F.R. 262.12, 263.11 or 264.1(j)(1) shall be deemed to include the “Director.”

3. Any reference to the “EPA” in 40 C.F.R. 264.11 or 265.11 shall be deemed to include the “Director.”

4. Fees required to be paid to the “U.S. Environmental Protection Agency” or the “United States Environmental Protection Agency” pursuant to section 2.107 of 40 C.F.R. must be paid to the “State of Nevada” and deposited in the Account for the Management of Hazardous Waste.

(Added to NAC by Environmental Comm’n, eff. 7-22-87; A 9-19-90; 1-2-92; 10-29-93; R170-99, 1-26-2000; R019-00, 5-26-2000; R175-05, 5-4-2006)

NAC 444.8655 Acquisition, preparation and distribution of manifests. ([NRS 459.485](#))

1. Except as otherwise provided in 40 C.F.R. Part 262, Subpart B, the generator shall include in the manifest the hazardous waste number assigned by the United States Environmental Protection Agency, if appropriate.

2. The manifest must consist of at least the number of copies which will provide:

(a) The Division with one copy;

(b) The generator, each transporter and the operator of the designated facility, one copy each; and

(c) Another copy to be returned to the generator upon completion of the shipment.

3. For shipments of waste out of the State, the generator shall, in addition to complying with the requirements for distribution set forth in 40 C.F.R. § 262.23, send one copy of the generator’s returned copy from the out-of-state facility to the Division within 30 days after his or her receipt of that copy.

4. The generator shall acquire his or her manifest as specified in 40 C.F.R. Part 262.21 or in the case of international shipment as specified in 40 C.F.R. Part 262, Subpart E.

(Added to NAC by Environmental Comm’n, eff. 11-22-82; A 6-29-84; 10-16-85; 7-22-87; 9-19-90)

NAC 444.8666 Receipt of hazardous waste accompanied by manifest. ([NRS 459.485](#)) If a facility receives hazardous waste accompanied by a manifest, the owner or operator, or his or her agent, shall:

1. Comply with the requirements for manifests set forth in 40 C.F.R. Part 264, Subpart E or 40 C.F.R. Part 265, Subpart E; and

2. Within 30 days after the delivery, send a copy of the manifest or shipping paper, for shipments transported by railroad, to the Division.

(Added to NAC by Environmental Comm’n, eff. 11-22-82; A 9-19-90)—(Substituted in revision for NAC 444.8960)

NAC 444.8671 Labeling of containers of hazardous waste accumulated or stored on-site. ([NRS 459.485](#)) A generator who accumulates or stores hazardous waste on-site shall, in addition to complying with the requirements for labeling set forth in 40 C.F.R. Part 262, include on the label of each container of hazardous waste, excluding those containers described in 40 C.F.R. § 262.34(c), the hazardous waste number assigned by the United States Environmental Protection Agency.

(Added to NAC by Environmental Comm’n, eff. 5-27-92; A by R202-97, 3-5-98)

NAC 444.8677 Written record of inspections by certain generators of hazardous waste. ([NRS 459.485](#), [459.550](#)) A generator who generates more than 100 kilograms of hazardous waste in a calendar month and accumulates hazardous waste on-site shall, in addition to complying with the requirements for accumulation set forth in 40 C.F.R. § 262.34, maintain a written record of inspections conducted of containers and tanks. Those records must be kept on-site for not less than 3 years and must include:

1. The date and time of an inspection;

2. The name of the inspector;

3. A notation of the inspector’s observations; and

4. The date and nature of any repairs made or other remedial action taken.

(Added to NAC by Environmental Comm’n, eff. 10-29-93)

NAC 444.8681 Mixing of used oil with hazardous waste or products prohibited; exceptions; recordkeeping requirements. ([NRS 459.485](#), [459.550](#))

1. The mixing of used oil with hazardous wastes is prohibited except for the following:

(a) Mixtures of used oil and a hazardous waste which is hazardous solely because it exhibits the characteristic of ignitability specified in 40 C.F.R. § 261.21 and is not listed in Subpart D of 40 C.F.R. Part 261, by a conditionally exempt small quantity generator who generates and mixes less than 5 gallons of such waste per calendar month with its used oil, if the resulting mixture does not exhibit the characteristic of ignitability specified in 40 C.F.R. § 261.21.

(b) Mixtures of used oil and waste gasoline, if the resulting mixture does not exhibit any of the characteristics of hazardous waste specified in Subpart C of 40 C.F.R. Part 261.

(c) Mixtures of used oil and waste diesel fuel. If such mixtures will be used for mining activities relating to extraction, express written approval must be granted by the Division before such use.

2. The mixing of used oil with products is prohibited except for the following:

(a) Mixtures of used oil and diesel fuel. If such mixtures will be used for mining activities relating to extraction, express written approval must be granted by the Division before such use.

(b) Mixtures of used oil and other fuels if such mixture will be used for the recovery of energy pursuant to 40 C.F.R. Part 279.

(c) Mixtures of used oil and sorbent materials when used only to manage isolated leaks and spills. Such mixtures must not contain any free liquid.

3. Conditionally exempt small quantity generators who mix hazardous waste with used oil pursuant to paragraph (a) of subsection 1 shall maintain records of the mixing for a minimum of 3 years. The records must include the quantity and description of the hazardous waste mixed with the used oil, the amount of used oil to which the waste was added and the date the mixing took place. In addition, such conditionally exempt small quantity generators shall, for not less than 3 years, maintain records on-site of all purchases of solvents that upon disposal would exhibit the characteristic of ignitability specified in 40 C.F.R. § 261.21. The records maintained pursuant to this subsection must be readily available for review.

(Added to NAC by Environmental Comm'n, eff. 3-1-94)

NAC 444.8682 Requirements for managing and disposing of mixtures of used oil and hazardous wastes or other products. ([NRS 459.485](#))

1. Mixtures of used oil with hazardous wastes that are exempted pursuant to subsection 1 of [NAC 444.8681](#) that are being recycled or burned for the recovery of energy must be managed in accordance with the requirements of 40 C.F.R. Part 279. If such mixtures are to be disposed of, they must be managed in accordance with the requirements of 40 C.F.R. Part 262.

2. Mixtures of used oil and hazardous wastes that are not exempted pursuant to subsection 1 of [NAC 444.8681](#) must be managed as a hazardous waste in accordance with the requirements of Subtitle C of the Resource Conservation and Recovery Act and [NAC 444.850](#) to [444.8746](#), inclusive.

3. Except as otherwise provided in subsection 4, mixtures of used oil and products that are exempted pursuant to subsection 2 of [NAC 444.8681](#) that are being reused or burned for the recovery of energy must be managed in accordance with the requirements of 40 C.F.R. Part 279.

4. Mixtures of used oil and sorbent materials that are exempted pursuant to paragraph (c) of subsection 2 of [NAC 444.8681](#) may be managed in accordance with the requirements of [NAC 444.570](#) to [444.7499](#), inclusive.

5. Mixtures of used oil and products that are not exempted pursuant to subsection 2 of [NAC 444.8681](#) must be managed as a hazardous waste in accordance with the requirements of Subtitle C of the Resource Conservation and Recovery Act and [NAC 444.850](#) to [444.8746](#), inclusive, until a determination has been made pursuant to [NAC 444.8683](#) that the waste is not hazardous.

(Added to NAC by Environmental Comm'n, eff. 3-1-93)

NAC 444.8683 Regulation of mixtures of used oil with wastes determined not to be hazardous. ([NRS 459.485](#)) Mixtures of used oil with wastes that are determined not to be hazardous are subject to regulation as used oil pursuant to 40 C.F.R. Part 279. Documentation of the determination that the waste was not hazardous must be maintained on-site and available for inspection while the waste is being generated and

for a minimum of 3 years.

(Added to NAC by Environmental Comm'n, eff. 3-1-93)

NAC 444.8686 Open burning of hazardous waste. (NRS 459.485) An operator shall not openly burn hazardous waste except for the open burning and detonation of waste explosives. For the purposes of this section, waste explosives include waste which has the potential to detonate and any bulk military propellants which cannot safely be disposed of through other treatment. For the purposes of this section, detonation is an explosion in which chemical transformation passes through the material faster than the speed of sound. An operator who openly burns hazardous waste or detonates waste explosives shall do so in accordance with 40 C.F.R. Part 264, Subpart X and the following table and in a manner that does not threaten human health or the environment.

Pounds of Waste Explosives or Propellants	Minimum Distance From Open Burning or Detonation to the Property of Others
0 to 100.....	204 meters
101 to 1,000.....	380 meters
1,001 to 10,000.....	530 meters
10,001 to 30,000.....	690 meters

(Added to NAC by Environmental Comm'n, eff. 11-22-82; A 9-19-90)—(Substituted in revision for NAC 444.9290)

NAC 444.8688 Transfer of hazardous waste from transport vehicle to boiler or industrial furnace. (NRS 459.485)

1. A person shall not transfer hazardous waste from a transport vehicle directly to a boiler or industrial furnace without the use of a storage unit.

2. An owner or operator of a boiler or industrial furnace may transfer hazardous waste from a transport vehicle to the boiler or furnace using a storage unit if he or she first obtains a permit for the storage of hazardous waste in the manner prescribed by 40 C.F.R. Part 270, as that Part existed on July 1, 2008.

(Added to NAC by Environmental Comm'n, eff. 1-2-92; A by R126-03, 4-13-2004; R175-05, 5-4-2006; R137-07, 1-30-2008; R015-08, 4-17-2008; R153-08, 4-23-2009)

Variances

NAC 444.8693 Submission of application for variance from certain federal regulations. (NRS 459.485, 459.548) An owner or operator of a facility for the management of hazardous waste may seek a variance from the requirements of 40 C.F.R. Parts 260, 264 and 268, as adopted by reference in [NAC 444.8632](#), by submitting an application for the variance to the Commission.

(Added to NAC by Environmental Comm'n, eff. 5-27-92; A by R126-03, 4-13-2004)

NAC 444.8696 Fee for processing and review of application for variance. ([NRS 459.485](#), [459.548](#))

1. Except as otherwise provided in subsection 2, the owner or operator of a facility for the management of hazardous waste shall pay to the Division, to offset the cost to process and review an application for a variance:

(a) A fee of \$50 for each hour of staff time devoted to processing and reviewing the application; and

(b) The actual cost of travel, per diem, salaries and any other expenses incurred by the Commission in connection with the application.

2. The maximum amount an applicant must pay pursuant to subsection 1 is:

(a) Five thousand dollars in the case of a facility or proposed facility handling less than 1,000 tons of hazardous waste annually.

(b) Ten thousand dollars in the case of a facility or proposed facility handling 1,000 tons or more but less than 10,000 tons of hazardous waste annually.

(c) Twenty thousand dollars in the case of a facility or proposed facility of unspecified capacity or handling 10,000 tons or more of hazardous waste annually.

3. The Division shall maintain an accurate account of the time and expense associated with the review of each application and, upon completion of the review, refund to the applicant any difference between:

(a) The amount required to cover the cost of the review; and

(b) The amount paid at the time the application was filed.

4. The Commission shall not issue a variance unless all applicable fees are paid.

(Added to NAC by Environmental Comm'n, eff. 5-27-92)

Administrative Penalties

NAC 444.8701 Definitions. ([NRS 459.485](#), [459.500](#)) As used in [NAC 444.8701](#) to [444.8746](#), inclusive:

1. "Administrator" means the Administrator of the Division.

2. "Hearing officer" means the Administrator or any person designated by him or her to conduct a hearing relating to a citation issued pursuant to [NAC 444.8711](#).

(Added to NAC by Environmental Comm'n, 9-19-90, eff. 12-1-90)

NAC 444.8706 Imposition and amounts. ([NRS 459.485](#), [459.500](#))

1. In addition to any other remedy provided by law for such a violation and except as otherwise provided in subsection 2, any person who violates any provision of [NRS 459.400](#) to [459.600](#), inclusive, or any regulation adopted pursuant to those sections, including the provisions of the federal regulations adopted by reference in [NAC 444.8632](#), may be required to pay an administrative penalty pursuant to [NRS 459.500](#) in an amount to be determined by the Division.

2. The administrative penalty may not exceed the amount specified in this subsection for a violation of any of the following provisions:

Section Violated	Nature of Violation	Maximum Penalty
40 C.F.R. § 262.11	Failure to determine whether solid waste is hazardous.	\$300
40 C.F.R. § 262.12(a)	Treatment, storage, disposal, transportation or offering for transportation of hazardous waste without identification number.	200
40 C.F.R. § 262.12(c)	Offering hazardous waste to	\$200

	transporter or facility which does not have identification number.	
40 C.F.R. § 262.20(a)	Failure to prepare manifest.	400
40 C.F.R. § 262.20(b)	Failure to designate facility on manifest.	200
40 C.F.R. § 262.20(d)	Failure to designate facility or instruct return of waste.	200
40 C.F.R. § 262.22	Insufficient number of copies of manifest.	200
40 C.F.R. § 262.23(a)(1)	Failure to sign manifest certification by hand.	100
40 C.F.R. § 262.23(a)(2)	Failure to obtain signature of initial transporter and date of acceptance on manifest.	100
40 C.F.R. § 262.23(a)(3)	Failure to retain copy of manifest.	100
40 C.F.R. § 262.23(b)	Failure to give transporter remaining copies of manifest.	300
40 C.F.R. § 262.23(d)	Failure to send required number of copies of dated and signed manifest for shipment by rail.	200
40 C.F.R. § 262.30	Failure to comply with regulations for packaging.	400 per load
40 C.F.R. § 262.31	Failure to comply with regulations for labeling.	200 per load
40 C.F.R. § 262.32(a)	Failure to comply with regulations for marking.	200 per load
40 C.F.R. § 262.32(b)	Failure to mark each container with required information.	200 per load
40 C.F.R. § 262.33	Failure to comply with regulations for placarding.	200 per load
40 C.F.R. § 262.34(a)	Accumulation of hazardous	1,000

	waste.	
40 C.F.R. § 262.34(c)(1)	Accumulation of hazardous waste or acutely hazardous waste.	300
40 C.F.R. § 262.34(d)	Accumulation of hazardous waste.	\$500
40 C.F.R. § 262.34(d)(1)	Accumulation of more than 6,000 kilograms of hazardous waste.	500
40 C.F.R. § 262.40(a)	Retention of copy of manifest.	200
40 C.F.R. § 262.40(b)	Retention of copies of reports.	200 per record
40 C.F.R. § 262.40(c)	Retention of records.	200
40 C.F.R. § 262.41	Failure to submit properly completed biennial report.	500
40 C.F.R. § 262.42(a)(1)	Determination by generator of status of waste.	100
40 C.F.R. § 262.42(a)(2)	Submittal of exception report.	100
NAC 444.8666	Failure to submit copy of manifest to the Division.	500
NAC 444.8671	Failure to label container properly.	100

(Added to NAC by Environmental Comm'n, 9-19-90, eff. 12-1-90; A 5-27-92)

NAC 444.8711 Issuance and contents of citations. ([NRS 459.485](#), [459.500](#))

1. Any authorized representative or employee of the Division who has probable cause to believe that a violation described in [NAC 444.8706](#) has occurred may issue a citation to the generator or other person responsible for the violation.

2. A citation issued pursuant to this section must:

- (a) Be in the form prescribed by the Division;
- (b) Identify the provision alleged to have been violated;
- (c) Contain a short and plain statement of the facts supporting the alleged violation; and
- (d) Set forth the amount of the penalty provided for the violation.

(Added to NAC by Environmental Comm'n, 9-19-90, eff. 12-1-90)

NAC 444.8716 Requests for forfeiture or hearing; scheduling and notice of hearing. ([NRS 459.485](#), [459.500](#))

1. A person who receives a citation pursuant to [NAC 444.8711](#) and does not desire to contest the matter must, within 30 days after the date of the citation, sign a request for forfeiture and deliver it to the Division, together with his or her copy of the citation and payment for the total amount of the penalty set forth in the

citation.

2. A person who is cited pursuant to [NAC 444.8711](#) and desires a hearing on the matter must, within the time provided by subsection 1, deliver a written request for hearing to the Division. The person shall include in the request a statement of the issues that he or she intends to raise at the hearing.

3. Upon receipt of a request for hearing, the Division shall:

- (a) Schedule the matter for hearing at the earliest practicable date; and
- (b) Deliver written notice of the hearing to the person.

4. Any delivery required by this section to be made to the office of the Division may be made personally or by mail, but the documents must be received by the Division before the expiration of the time provided by this section.

(Added to NAC by Environmental Comm'n, 9-19-90, eff. 12-1-90)

NAC 444.8721 Failure to request forfeiture or hearing or to appear at hearing. ([NRS 459.485](#), [459.500](#)) If a person cited pursuant to [NAC 444.8711](#) fails to deliver a request for forfeiture or a request for hearing within the time required by [NAC 444.8716](#), or fails to appear at a scheduled hearing, the Department may proceed to recover a civil penalty and damages for the violation as provided by [NRS 459.585](#).

(Added to NAC by Environmental Comm'n, 9-19-90, eff. 12-1-90)

NAC 444.8726 Continuance of hearing. ([NRS 459.485](#), [459.500](#))

1. If a request for hearing is made and granted pursuant to [NAC 444.8716](#), the person cited may request a continuance of the hearing by delivering a written request to the hearing officer. The request may be granted or denied at the discretion of the hearing officer.

2. Except as otherwise ordered by the hearing officer for good cause:

(a) A request for continuance:

(1) Must state the basis for the request; and

(2) Must be received by the hearing officer not less than 5 business days before the scheduled date of the hearing.

(b) A continuance will not be granted for more than 30 days after the date previously scheduled for the hearing.

(Added to NAC by Environmental Comm'n, 9-19-90, eff. 12-1-90; A 5-27-92)

NAC 444.8731 Inspection and copying of documents Division intends to use at hearing. ([NRS 459.485](#), [459.500](#)) If a request for hearing is granted, the person cited is entitled before the hearing to inspect and copy any document that the Division intends to present to the hearing officer. The Division may charge a fee, not to exceed the cost of reproduction, for each copy of any such document.

(Added to NAC by Environmental Comm'n, 9-19-90, eff. 12-1-90)

NAC 444.8736 Rendering of decision by hearing officer. ([NRS 459.485](#), [459.500](#)) Within 30 days after the end of a hearing, the hearing officer shall prepare and file a decision in writing. The decision must include a statement of the reasons for the conclusion reached by the hearing officer. The hearing officer shall cause a copy of the decision to be delivered, personally or by certified mail, to the person cited.

(Added to NAC by Environmental Comm'n, 9-19-90, eff. 12-1-90)

NAC 444.8741 Address for delivery of documents. ([NRS 459.485](#), [459.500](#)) Any delivery required by [NAC 444.8701](#) to [444.8746](#), inclusive, to be made to:

1. The Division must be made to the office of the Division at Bryan State Office Building, 901 South Stewart Street, Carson City, Nevada 89701-5249.

2. The person cited must be made to him or her at the address set forth in the citation or, if the person has made a request for hearing, at the address set forth in the request.

(Added to NAC by Environmental Comm'n, 9-19-90, eff. 12-1-90; A by R015-08, 4-17-2008)

NAC 444.8746 Methods of payment. ([NRS 459.485](#), [459.500](#)) Payment of an administrative penalty

imposed pursuant to [NAC 444.8706](#) must be made by money order, bank draft or check payable to the State of Nevada.

(Added to NAC by Environmental Comm'n, 9-19-90, eff. 12-1-90)

RECYCLING OF USED ANTIFREEZE

General Provisions

NAC 444.8801 Definitions. As used in [NAC 444.8801](#) to [444.9071](#), inclusive, unless the context otherwise requires, the words and terms defined in [NAC 444.8806](#) to [444.8866](#), inclusive, have the meanings ascribed to them in those sections.

(Supplied in codification)

NAC 444.8806 “Administrator” defined. ([NRS 459.485](#)) “Administrator” means the Administrator of the Division.

(Added to NAC by Environmental Comm'n, eff. 10-3-96)

NAC 444.8811 “Center for the collection of used antifreeze” defined. ([NRS 459.485](#)) “Center for the collection of used antifreeze” means any facility that accepts, aggregates or stores used antifreeze which is collected from:

1. Generators of used antifreeze that are governed by the provisions of [NAC 444.8911](#) to [444.8931](#), inclusive; or

2. A person who generates used antifreeze from his or her household.

È The term does not include a generator of used antifreeze who collects his or her used antifreeze in compliance with the provisions of [NAC 444.8911](#) to [444.8931](#), inclusive.

(Added to NAC by Environmental Comm'n, eff. 10-3-96)

NAC 444.8816 “Commission” defined. ([NRS 459.485](#)) “Commission” means the State Environmental Commission.

(Added to NAC by Environmental Comm'n, eff. 10-3-96)

NAC 444.8821 “Division” defined. ([NRS 459.485](#)) “Division” means the Division of Environmental Protection of the State Department of Conservation and Natural Resources.

(Added to NAC by Environmental Comm'n, eff. 10-3-96)

NAC 444.8826 “Facility for the recycling of used antifreeze” defined. ([NRS 459.485](#))

1. “Facility for the recycling of used antifreeze” means a facility that receives used antifreeze from another site, performs recycling of the used antifreeze and is permanently stationed at a single facility.

2. The term includes the contiguous land and any structures, other appurtenances or improvements on the land which are used for the recycling of used antifreeze.

3. The term does not include a generator of used antifreeze who recycles his or her own used antifreeze or has it recycled by a mobile unit for the recycling of used antifreeze.

(Added to NAC by Environmental Comm'n, eff. 10-3-96)

NAC 444.8831 “Facility for the transfer of used antifreeze” defined. ([NRS 459.485](#))

1. “Facility for the transfer of used antifreeze” means a facility where shipments of used antifreeze are transported to and stored for more than 24 hours but not more than 35 days.

2. The term includes, without limitation, loading docks and parking areas.

3. The term does not include a generator of used antifreeze who transfers his or her used antifreeze in compliance with the provisions of [NAC 444.8911](#) to [444.8931](#), inclusive.

(Added to NAC by Environmental Comm'n, eff. 10-3-96)

NAC 444.8836 “Generator of used antifreeze” defined. ([NRS 459.485](#)) “Generator of used

antifreeze” means a person or facility that performs an act or conducts a process which produces used antifreeze.

(Added to NAC by Environmental Comm’n, eff. 10-3-96)

NAC 444.8841 “Hazardous waste” defined. (NRS 459.485)

1. “Hazardous waste” has the meaning ascribed to it in [NRS 459.430](#).
2. The term includes any:
 - (a) Hazardous waste or constituent of hazardous waste which is subject to regulation under 40 C.F.R. Part 261; and
 - (b) Waste brought into this State which is designated as hazardous waste in the state of its origin.
3. The term does not include waste containing polychlorinated biphenyl, unless it is mixed with hazardous waste.

(Added to NAC by Environmental Comm’n, eff. 10-3-96; A by R170-99, 1-26-2000)

NAC 444.8846 “Identification number” defined. (NRS 459.485) “Identification number” means an identification number issued by the Environmental Protection Agency or by an agency of a state authorized by the Environmental Protection Agency to issue such numbers.

(Added to NAC by Environmental Comm’n, eff. 10-3-96; A by R126-03, 4-13-2004)

NAC 444.8851 “Mobile unit for the recycling of used antifreeze” defined. (NRS 459.485) “Mobile unit for the recycling of used antifreeze” means any transportable equipment which is used to perform recycling of used antifreeze and is not permanently stationed to a single facility.

(Added to NAC by Environmental Comm’n, eff. 10-3-96)

NAC 444.8856 “Point for aggregation” defined. (NRS 459.485) “Point for aggregation” means a facility that accepts, aggregates or stores used antifreeze which is collected from:

1. Another site where used antifreeze is generated which is owned or operated by the owner or operator of the point for aggregation; or
2. A person who generates used antifreeze from his or her household.

(Added to NAC by Environmental Comm’n, eff. 10-3-96)

NAC 444.8861 “Transporter of used antifreeze” defined. (NRS 459.485) “Transporter of used antifreeze” means a person who:

1. Transports used antifreeze;
2. Collects used antifreeze from more than one generator of used antifreeze and transports the used antifreeze; or
3. Owns or operates a facility for the transfer of used antifreeze.

Ê The term does not include a generator of used antifreeze who transports his or her used antifreeze in compliance with the provisions of [NAC 444.8911](#) to [444.8931](#), inclusive.

(Added to NAC by Environmental Comm’n, eff. 10-3-96)

NAC 444.8866 “Used antifreeze” defined. (NRS 459.485) “Used antifreeze” means ethylene glycol or propylene glycol that has been used and as a result of such use is contaminated by physical or chemical impurities.

(Added to NAC by Environmental Comm’n, eff. 10-3-96)

NAC 444.8871 Applicability. (NRS 459.485)

1. The provisions of [NAC 444.8801](#) to [444.9071](#), inclusive, apply to used antifreeze that is recycled and is determined to be a hazardous waste because:

- (a) It exhibits a characteristic of hazardous waste which is identified in 40 C.F.R. Part 261, Subpart C, as that Part existed on July 1, 2008; or
- (b) It was designated as a hazardous waste in the state of its origin.

2. The provisions of [NAC 444.8801](#) to [444.9071](#), inclusive, do not apply to used antifreeze which will be disposed of and not recycled, or to mixtures of used antifreeze and hazardous waste. The used antifreeze described in this subsection is governed by the provisions of [NAC 444.850](#) to [444.8746](#), inclusive.

(Added to NAC by Environmental Comm'n, eff. 10-3-96; A by R126-03, 4-13-2004; R175-05, 5-4-2006; R137-07, 1-30-2008; R015-08, 4-17-2008; R153-08, 4-23-2009)

General Requirements

NAC 444.8876 Containers and tanks for storage of used antifreeze: General requirements. ([NRS 459.485](#)) Each container and storage tank that is above the ground which stores used antifreeze must be:

1. In good condition, including, without limitation, being free from severe rusting, visible structural defects or deterioration;

2. Free from visible leaks;

3. Closed unless material is being added or removed; and

4. Clearly marked with the words "Used Antifreeze."

(Added to NAC by Environmental Comm'n, eff. 10-3-96)

NAC 444.8881 Underground storage tanks: Compliance with federal regulations; identification of pipes. ([NRS 459.485](#))

1. Each storage tank that is underground which stores used antifreeze must comply with the requirements of 40 C.F.R. Part 265, Subpart J, as that Subpart existed on July 1, 2008.

2. Each pipe that transfers used antifreeze to storage tanks that are underground must be clearly marked with the words "Used Antifreeze."

(Added to NAC by Environmental Comm'n, eff. 10-3-96; A by R126-03, 4-13-2004; R175-05, 5-4-2006; R137-07, 1-30-2008; R015-08, 4-17-2008; R153-08, 4-23-2009)

NAC 444.8886 Container: Secondary system for containment. ([NRS 459.485](#)) Each container which stores used antifreeze at a facility for the transfer of used antifreeze or a facility for the recycling of used antifreeze must have a secondary system for containment which:

1. Includes dikes, berms or retaining walls, or the equivalent, which are impervious to the penetration of used antifreeze;

2. Includes a floor, or the equivalent, which covers the entire area within the dike, berm or retaining wall and is impervious to the penetration of used antifreeze;

3. Is large enough to prevent the release of used antifreeze into the soil, groundwater or surface water; and

4. Has the capacity to contain either 10 percent of the total volume of the containers within the system or the volume of the largest container within the system, excluding a container which contains no free liquid, whichever is greater.

(Added to NAC by Environmental Comm'n, eff. 10-3-96; A by R202-97, 3-5-98)

NAC 444.8891 Above-ground storage tank: Secondary system for containment. ([NRS 459.485](#))

1. Each storage tank that is above the ground which stores used antifreeze at a facility for the transfer of used antifreeze or a facility for the recycling of used antifreeze must have a secondary system for containment which:

(a) Includes dikes, berms or retaining walls, or the equivalent, which are impervious to the penetration of used antifreeze;

(b) Except as otherwise provided in subsection 2, includes a floor, or the equivalent, which covers the entire area within the dike, berm or retaining wall and is impervious to the penetration of used antifreeze; and

(c) Is large enough to prevent the release of used antifreeze into the soil, groundwater or surface water.

2. If a storage tank that is above the ground is being used as of October 3, 1996, the floor of the secondary system for containment is not required to cover that portion of the tank which has contact with the ground.

(Added to NAC by Environmental Comm'n, eff. 10-3-96)

NAC 444.8896 Required action upon release of used antifreeze. ([NRS 459.485](#)) If used antifreeze which is not governed by the requirements of 40 C.F.R. Part 280, Subpart F, is released into the environment, a person, center or facility that is governed by the provisions of [NAC 444.8911](#) to [444.8931](#), inclusive, [444.8936](#) to [444.8986](#), inclusive, or [444.8991](#) to [444.9046](#), inclusive, shall, as soon as the release is discovered:

1. Immediately stop the release of used antifreeze into the environment;
2. Immediately contain, if possible, the used antifreeze which was released;
3. Clean up and properly manage the used antifreeze which was released and any other materials that were released; and
4. If necessary to prevent future releases of used antifreeze, repair or replace any storage tanks or containers.

(Added to NAC by Environmental Comm'n, eff. 10-3-96; A by R126-03, 4-13-2004)

NAC 444.8901 Required report of release of used antifreeze. ([NRS 459.485](#), [459.550](#)) In addition to the requirements of [NAC 444.8896](#), a person, center, point for aggregation or facility that is governed by the provisions of [NAC 444.8911](#) to [444.8931](#), inclusive, [444.8936](#) to [444.8986](#), inclusive, or [444.8991](#) to [444.9046](#), inclusive, shall, not more than 24 hours after a release, report the release by telephone to:

1. The National Response Center, in accordance with 40 C.F.R. Part 302, at (800) 424-8802 or (202) 267-2675; and
2. The Director of the State Department of Conservation and Natural Resources at (888) 331-6337 or (775) 687-9485.

(Added to NAC by Environmental Comm'n, eff. 10-3-96; A by R021-99, 9-27-99; R126-03, 4-13-2004)

NAC 444.8906 Required report of release of used antifreeze into body of water. ([NRS 459.485](#), [459.550](#)) If used antifreeze is released into a body of water in this State, a person, center, point for aggregation or facility that is governed by the provisions of [NAC 444.8911](#) to [444.8931](#), inclusive, [444.8936](#) to [444.8986](#), inclusive, or [444.8991](#) to [444.9046](#), inclusive, shall, not more than 24 hours after a release, report the release by telephone to the Director of the State Department of Conservation and Natural Resources at (888) 331-6337 or (775) 687-9485.

(Added to NAC by Environmental Comm'n, eff. 10-3-96; A by R021-99, 9-27-99; R126-03, 4-13-2004)

Generation, Collection and Aggregation

NAC 444.8911 Applicability. ([NRS 459.485](#))

1. The provisions of [NAC 444.8911](#) to [444.8931](#), inclusive, apply to:
 - (a) Generators of used antifreeze, except for persons who generate used antifreeze from their households.
 - (b) Centers for the collection of used antifreeze.
 - (c) Points for aggregation.
2. The provisions of [NAC 444.8911](#) to [444.8931](#), inclusive, do not apply to wastewater which contains a small amount of used antifreeze, if the discharge of antifreeze is governed by paragraph (b) of section 307 of the Clean Water Act, 33 U.S.C. § 1317, or section 402 of the Clean Water Act, 33 U.S.C. § 1342. For the purposes of this subsection, wastewater contains a small amount of used antifreeze if the antifreeze is discharged as a result of small spills, leaks or drips from pumps, machinery, pipes and other equipment which occur during normal operations of the facility or discharged into a system for the treatment of wastewater during the washing or draining operations of the system. Wastewater contains more than a small amount of used antifreeze if the antifreeze is discharged as a result of substantial leaks, spills or other releases which occur during abnormal operations of the facility, or if the used antifreeze is recaptured from the wastewater.

(Added to NAC by Environmental Comm'n, eff. 10-3-96; A by R126-03, 4-13-2004)

NAC 444.8916 Mixing of used antifreeze with solid or hazardous waste forbidden; storage. ([NRS 459.485](#))

1. A generator of used antifreeze shall not mix any solid waste or hazardous waste with used antifreeze.
2. A generator of used antifreeze shall store his or her used antifreeze in containers or storage tanks that

are above the ground, or both, which comply with the requirements of [NAC 444.8876](#).

(Added to NAC by Environmental Comm'n, eff. 10-3-96)

NAC 444.8921 Center for collection of used antifreeze: Registration. ([NRS 459.485](#)) A center for the collection of used antifreeze shall register with the Division for permission to manage used antifreeze. An application for registration may be obtained from the Division.

(Added to NAC by Environmental Comm'n, eff. 10-3-96)

NAC 444.8926 Recycling of used antifreeze for personal use: Requirements; calculation in determination of status; management of waste as hazardous waste. ([NRS 459.485](#))

1. A generator of used antifreeze may recycle his or her used antifreeze for the generator's own use if the recycling:

(a) Is performed by the generator at a site which is located where the used antifreeze was generated; or

(b) Is performed pursuant to a written contract by a mobile unit for the recycling of used antifreeze which is located where the used antifreeze was generated.

2. Used antifreeze which is recycled pursuant to this section will not be calculated in the determination of the status of the generator of used antifreeze as a generator of hazardous waste pursuant to 40 C.F.R. Part 262, as that Part existed on July 1, 2008.

3. A person who performs recycling pursuant to this section shall manage any waste which is generated during the recycling process pursuant to the provisions of [NAC 444.850](#) to [444.8746](#), inclusive.

4. A generator who recycles his or her used antifreeze pursuant to paragraph (a) of subsection 1 is not required to obtain a written determination pursuant to [NAC 444.8455](#) and [444.84555](#).

(Added to NAC by Environmental Comm'n, eff. 10-3-96; A by R126-03, 4-13-2004; R175-05, 5-4-2006; R137-07, 1-30-2008; R015-08, 4-17-2008; R153-08, 4-23-2009)

NAC 444.8931 Transport of used antifreeze: Responsibilities of generator; calculation in determination of status. ([NRS 459.485](#), [459.550](#))

1. Except as otherwise provided in this section, a generator of used antifreeze shall ensure that his or her used antifreeze is transported by persons who hold an identification number.

2. A generator may transport, without an identification number, used antifreeze generated at a site which is owned by the generator or collected from a person who generated the used antifreeze from his or her household if:

(a) The used antifreeze is transported in a motor vehicle which is owned by the generator or an employee of the generator;

(b) Not more than 350 gallons of used antifreeze is transported at one time; and

(c) The used antifreeze is transported to a point for aggregation or a center for the collection of used antifreeze which is registered pursuant to [NAC 444.8921](#).

3. Used antifreeze which is transported pursuant to this section will not be calculated in the determination of the status of the generator of used antifreeze as a generator of hazardous waste pursuant to 40 C.F.R. Part 262, as that Part existed on July 1, 2008, if he or she maintains records which describe the disposition of the used antifreeze. The records must be maintained for at least 3 years and be made available, upon request, for inspection by a representative of the Division or the Commission. The records may be in the form of a log, copies of contractual agreements, invoices, bills of lading or other documents relating to shipping which show each shipment of used antifreeze that is transported for recycling. The records must include:

(a) The name and address of the generator;

(b) The identification number of the generator, if he or she has an identification number;

(c) The name and address of the center for the collection of used antifreeze or the facility for the recycling of used antifreeze with whom the generator has contracted to recycle the used antifreeze;

(d) The identification number of the center or facility, if it has an identification number;

(e) The amount of used antifreeze that is transported for recycling; and

(f) The signature and date of acceptance of the representative of the center or facility.

(Added to NAC by Environmental Comm'n, eff. 10-3-96; A by R126-03, 4-13-2004; R175-05, 5-4-2006;

R137-07, 1-30-2008; R015-08, 4-17-2008; R153-08, 4-23-2009)

Transport and Transfer

NAC 444.8936 Applicability. (NRS 459.485)

1. Except as otherwise provided in this section, the provisions of [NAC 444.8936](#) to [444.8986](#), inclusive, apply to all transporters of used antifreeze. The provisions of [NAC 444.8936](#) to [444.8986](#), inclusive, apply to the transportation of used antifreeze for the purposes of import into this State and export from this State while the used antifreeze is located in this State.

2. The provisions of [NAC 444.8936](#) to [444.8986](#), inclusive, do not apply to the transportation of used antifreeze on the site where the used antifreeze was generated.

3. The provisions of [NAC 444.8936](#) to [444.8986](#), inclusive, do not apply to the transportation of used antifreeze which was generated at a site owned by the generator of used antifreeze or collected from a person who generates used antifreeze from his or her household if:

(a) The used antifreeze is transported in a motor vehicle which is owned by the generator or an employee of the generator;

(b) Not more than 350 gallons of used antifreeze is transported at one time; and

(c) The used antifreeze is transported to:

(1) A center for the collection of used antifreeze which is registered pursuant to [NAC 444.8921](#); or

(2) A point for aggregation which is owned or operated by the generator.

4. The provisions of [NAC 444.8936](#) to [444.8986](#), inclusive, do not apply to the initial transportation of used antifreeze generated from a household if the used antifreeze is transported to:

(a) A generator of used antifreeze;

(b) A center for the collection of used antifreeze;

(c) A point for aggregation;

(d) A facility for the recycling of used antifreeze; or

(e) A mobile unit for the recycling of used antifreeze.

Ê If the used antifreeze has been transported from a household pursuant to this subsection, the provisions of [NAC 444.8936](#) to [444.8986](#), inclusive, apply to the subsequent transportation of the used antifreeze unless the transportation is otherwise exempt pursuant to this section.

(Added to NAC by Environmental Comm'n, eff. 10-3-96)

NAC 444.8941 Management of used antifreeze transported in truck used for hazardous waste. (NRS 459.485) If a transporter of used antifreeze transports used antifreeze in a truck which was used to transport hazardous waste, he or she shall manage the used antifreeze as a hazardous waste pursuant to the provisions of [NAC 444.850](#) to [444.8746](#), inclusive, unless the transporter removes the hazardous waste from the truck in accordance with 40 C.F.R. § 261.7, as that section existed on July 1, 2008, before transporting the used antifreeze.

(Added to NAC by Environmental Comm'n, eff. 10-3-96; A by R126-03, 4-13-2004; R175-05, 5-4-2006; R137-07, 1-30-2008; R015-08, 4-17-2008; R153-08, 4-23-2009)

NAC 444.8946 Consolidation or aggregation; processing forbidden; exception. (NRS 459.485)

1. A transporter of used antifreeze may consolidate or aggregate loads of used antifreeze for the purpose of transporting the used antifreeze.

2. Except as otherwise provided in this subsection, a transporter of used antifreeze shall not perform any operations which process the used antifreeze unless he or she complies with the provisions of [NAC 444.8991](#) to [444.9046](#), inclusive. A transporter may perform operations which process the used antifreeze if the processing is a result of the normal operation of the transportation, including, without limitation, skimming or separating the used antifreeze.

(Added to NAC by Environmental Comm'n, eff. 10-3-96)

NAC 444.8951 Identification number; compliance with federal regulations. (NRS 459.485)

1. Except as otherwise provided in subsection 2 of [NAC 444.8931](#), a transporter of used antifreeze must

hold an identification number. A person may obtain information relating to the procedure to obtain the identification number and an application by submitting a request in writing to the Division of Environmental Protection, Bryan State Office Building, 901 South Stewart Street, Carson City, Nevada 89701-5249, or by telephone at (775) 687-9481.

2. A transporter of used antifreeze shall comply with all applicable provisions of 49 C.F.R. Parts 173, 178 and 179, which govern the packaging, labeling and placarding of hazardous waste.

(Added to NAC by Environmental Comm'n, eff. 10-3-96; A by R202-97, 3-5-98; R126-03, 4-13-2004; R175-05, 5-4-2006)

NAC 444.8956 Required destinations after transport. ([NRS 459.485](#)) A transporter of used antifreeze shall transport all used antifreeze to:

1. Another transporter of used antifreeze who holds an identification number; or
2. A facility for the recycling of used antifreeze which has an identification number and written determination issued by the Administrator pursuant to [NAC 444.8455](#) and [444.84555](#).

(Added to NAC by Environmental Comm'n, eff. 10-3-96)

NAC 444.8961 Records of used antifreeze accepted for transport: Maintenance; contents. ([NRS 459.485](#), [459.550](#)) A transporter of used antifreeze shall maintain records of all used antifreeze accepted by him or her for the purpose of transport. The transporter shall maintain the records for at least 3 years and, upon request, provide the records for inspection by a representative of the Division. The record for each shipment of used antifreeze accepted by the transporter must include:

1. The name and address of the person or facility that provided the used antifreeze;
2. The identification number of the person, if he or she has an identification number, or the facility, if it has an identification number;
3. The quantity of used antifreeze accepted by the transporter; and
4. The signature and date of delivery of the representative of the person or facility that provided the used antifreeze.

(Added to NAC by Environmental Comm'n, eff. 10-3-96)

NAC 444.8966 Records of used antifreeze delivered to transporter: Maintenance; contents. ([NRS 459.485](#), [459.550](#)) A transporter of used antifreeze shall maintain records of all used antifreeze which is delivered by him or her to another transporter or a facility for the recycling of used antifreeze, including a transporter or facility that is located in a foreign county. The transporter shall maintain the records for at least 3 years and, upon request, provide the records for inspection by a representative of the Division. The record for each delivery of used antifreeze must include:

1. The name and address of the facility or transporter which received the used antifreeze from the transporter;
2. The identification number of the facility, if it has an identification number, or the transporter, if he or she has an identification number;
3. The quantity of used antifreeze that was delivered to the facility or transporter;
4. The date of delivery of the used antifreeze; and
5. The signature of a representative of the transporter or facility that received the used antifreeze from the transporter, unless the used antifreeze is delivered to a foreign country.

(Added to NAC by Environmental Comm'n, eff. 10-3-96)

NAC 444.8971 Release of used antifreeze during transport. ([NRS 459.485](#))

1. If used antifreeze is released during transportation, the transporter of the used antifreeze shall immediately take action which is necessary to protect human health and the environment, including, without limitation, notification of the local, state and federal officials in the location where the release occurred.

2. If an official from a local, state or federal agency determines that the used antifreeze must be immediately removed to protect human health or the environment, that official may authorize the transportation of the used antifreeze by transporters who have not been issued an identification number.

3. If used antifreeze is released during transportation, the transporter shall clean up the release and take such action as is required or approved by an official from a local, state or federal agency.

4. If used antifreeze is released during transportation, the transporter shall comply with the provisions of this section and [NAC 444.8896](#) and [444.8901](#).

(Added to NAC by Environmental Comm'n, eff. 10-3-96)

NAC 444.8976 Release of used antifreeze into body of water during transport. ([NRS 459.485](#), [459.550](#)) If used antifreeze is released during transportation into a body of water which is located in this State, the person who transports the used antifreeze shall:

1. Comply with the provisions of [NAC 444.8906](#);

2. If required by 40 C.F.R. Part 302 or 49 C.F.R. § 171.15, report the release to the National Response Center at (800) 424-8802 or (202) 267-2675; and

3. If required by 49 C.F.R. § 171.16, provide a written report of the release to the Information Systems Manager, DHM-63, Research and Special Programs Administration, Department of Transportation, Washington, DC 20509-0001.

(Added to NAC by Environmental Comm'n, eff. 10-3-96; A by R126-03, 4-13-2004)

NAC 444.8981 Storage: Tanks and containers. ([NRS 459.485](#)) An owner or operator of a facility for the transfer of used antifreeze shall store the used antifreeze at the facility in storage tanks or containers, or both, which comply with the applicable requirements of [NAC 444.8876](#) to [444.8891](#), inclusive.

(Added to NAC by Environmental Comm'n, eff. 10-3-96)

NAC 444.8986 Storage: Maximum duration. ([NRS 459.485](#)) An owner or operator of a facility for the transfer of used antifreeze shall not store used antifreeze for more than 35 days.

(Added to NAC by Environmental Comm'n, eff. 10-3-96)

Facilities for Recycling

NAC 444.8991 Applicability. ([NRS 459.485](#)) The provisions of [NAC 444.8991](#) to [444.9046](#), inclusive, apply to facilities for the recycling of used antifreeze which perform recycling of used antifreeze at a location other than the location where the used antifreeze was generated.

(Added to NAC by Environmental Comm'n, eff. 10-3-96)

NAC 444.8996 Written determination; identification number. ([NRS 459.485](#))

1. An owner or operator of a facility for the recycling of used antifreeze shall obtain a written determination from the Administrator pursuant to [NAC 444.8455](#) and [444.84555](#).

2. An owner or operator of a facility for the recycling of used antifreeze shall obtain an identification number. A person may obtain information relating to the procedure to obtain the identification number and an application by submitting a request in writing to the Division of Environmental Protection, Bryan State Office Building, 901 South Stewart Street, Carson City, Nevada 89701-5249, or by telephone at (775) 687-9481.

(Added to NAC by Environmental Comm'n, eff. 10-3-96; A by R126-03, 4-13-2004; R175-05, 5-4-2006)

NAC 444.9001 Storage: Tanks and containers. ([NRS 459.485](#)) An owner or operator of a facility for the recycling of used antifreeze shall store used antifreeze at the facility in storage tanks or containers, or both, which comply with the applicable requirements of [NAC 444.8876](#) to [444.8891](#), inclusive.

(Added to NAC by Environmental Comm'n, eff. 10-3-96)

NAC 444.9006 Requirements when above-ground storage tank no longer used. ([NRS 459.485](#))

1. Except as otherwise provided in subsection 2, if a storage tank that is above the ground is no longer used at a facility for the recycling of used antifreeze, the owner or operator of the facility shall ensure that the used antifreeze, including its residue, is decontaminated or removed from the storage tank, system for

containment, soil and other structures or equipment which are contaminated with used antifreeze. The owner or operator shall manage the used antifreeze as a hazardous waste unless it does not exhibit a characteristic of hazardous waste identified in 40 C.F.R. Part 261, as that Part existed on July 1, 2008.

2. If the owner or operator demonstrates to the satisfaction of the Division that the used antifreeze cannot be removed or decontaminated as required by subsection 1, he or she must follow the procedures for closure and postclosure set forth in 40 C.F.R. § 265.310, as that section existed on July 1, 2008.

(Added to NAC by Environmental Comm'n, eff. 10-3-96; A by R126-03, 4-13-2004; R175-05, 5-4-2006; R137-07, 1-30-2008; R015-08, 4-17-2008; R153-08, 4-23-2009)

NAC 444.9011 Requirements when facility is closed. ([NRS 459.485](#)) If a facility for the recycling of used antifreeze is closed, the owner or operator of the facility shall ensure that containers which are used to store used antifreeze, including its residue, are removed from the facility and that systems for containment, soil and other structures or equipment which are contaminated with used antifreeze are decontaminated or removed. Material that is removed must be managed as a hazardous waste unless it does not exhibit a characteristic of hazardous waste which is identified in 40 C.F.R. Part 261, as that Part existed on July 1, 2008.

(Added to NAC by Environmental Comm'n, eff. 10-3-96; A by R126-03, 4-13-2004; R175-05, 5-4-2006; R137-07, 1-30-2008; R015-08, 4-17-2008; R153-08, 4-23-2009)

NAC 444.9016 Records of used antifreeze accepted by facility: Maintenance; contents. ([NRS 459.485](#), [459.550](#)) An owner or operator of a facility for the recycling of used antifreeze shall maintain records of all used antifreeze accepted by the facility. The records must be maintained for at least 3 years and be made available, upon request, for inspection by a representative of the Division. The records may be in the form of a log, copies of contractual agreements, invoices, bills of lading or other documents relating to shipping which show each shipment of used antifreeze accepted by the facility for the purpose of recycling. The record for each shipment of used antifreeze accepted by the facility must include:

1. The name and address of the person, or the owner or operator of the facility that provided the used antifreeze;
2. The identification number of the person, or the owner or operator that provided the used antifreeze, if he or she has an identification number;
3. The quantity of used antifreeze accepted by the facility; and
4. The signature and date of acceptance of the representative of the person, or the owner or operator that provided the used antifreeze.

(Added to NAC by Environmental Comm'n, eff. 10-3-96)

NAC 444.9021 Management of residue as hazardous waste. ([NRS 459.485](#)) An owner or operator of a facility for the recycling of used antifreeze shall manage any residue of used antifreeze which is generated by the storage or recycling of used antifreeze in accordance with the provisions of [NAC 444.850](#) to [444.8746](#), inclusive.

(Added to NAC by Environmental Comm'n, eff. 10-3-96)

NAC 444.9026 Responsibility of owner or operator that used antifreeze not be mixed with hazardous waste; creation, maintenance and review of written plan. ([NRS 459.485](#))

1. An owner or operator of a facility for the recycling of used antifreeze shall ensure that the used antifreeze managed at the facility is not mixed with hazardous waste. The owner or operator shall submit to the Division a written plan for the characterization of waste which describes the procedures that will be used at the facility to detect hazardous waste at the facility. The facility must not begin operations until the Division has approved the written plan.

2. The written plan must be reviewed, and amended if necessary, if the quantity or source of waste streams received at the facility changes significantly.

3. The written plan must be maintained at the facility and be made available, upon request, for review by a representative of the Division.

(Added to NAC by Environmental Comm'n, eff. 10-3-96)

NAC 444.9031 Contingency plan in case of release: Contents; review and amendment; maintenance. ([NRS 459.485](#))

1. An owner or operator of a facility for the recycling of used antifreeze shall develop a plan for contingency to be followed if used antifreeze is released into the soil, groundwater or surface water. The plan must:

(a) Be designed to minimize hazards to human health, public safety and the environment upon the release of used antifreeze; and

(b) Describe the actions that personnel employed at the facility will be required to take upon the release of used antifreeze.

2. A facility for the recycling of used antifreeze shall review, and amend if necessary, its plan for contingency if:

(a) The plan fails in an emergency;

(b) The facility undergoes a change in its design, construction, operation, or maintenance or undergoes other changes which increase the potential for the release of used antifreeze; or

(c) The facility changes its procedures for managing a release of used antifreeze.

3. The plan for contingency must be maintained at the facility for recycling and be made available, upon request, for review by a representative of the Division.

(Added to NAC by Environmental Comm'n, eff. 10-3-96)

NAC 444.9036 Responsibility of owner or operator for weekly inspection of storage tanks and containers. ([NRS 459.485](#), [459.550](#)) An owner or operator of a facility for the recycling of used antifreeze shall ensure that all containers and storage tanks at the facility, including the secondary systems for containment, are inspected at least once per week. The containers and storage tanks must be inspected for evidence of leaks and deterioration caused by corrosion or other factors. Each inspection must be documented in the written record of operation.

(Added to NAC by Environmental Comm'n, eff. 10-3-96)

NAC 444.9041 Written record of operation. ([NRS 459.485](#), [459.550](#))

1. An owner or operator of a facility for the recycling of used antifreeze shall maintain a written record of operation. The record of operation must include:

(a) The records and results of analyses performed on used antifreeze at the facility pursuant to [NAC 444.9026](#);

(b) Reports which summarize all incidents which required the facility to use its plan for contingency;

(c) A copy of the application for a written determination submitted by the facility pursuant to [NAC 444.84555](#);

(d) A copy of the written determination issued to the facility by the Administrator;

(e) The records for each shipment of antifreeze maintained pursuant to [NAC 444.9016](#); and

(f) The records of inspections of the containers and storage tanks used at the facility pursuant to [NAC 444.9036](#).

2. The record of operation must be maintained at the facility until the closure of the facility.

(Added to NAC by Environmental Comm'n, eff. 10-3-96)

NAC 444.9046 Written report. ([NRS 459.485](#), [459.550](#))

1. An owner or operator of a facility for the recycling of used antifreeze shall submit a written report to the Administrator which includes:

(a) The name and address of the facility;

(b) The identification number issued to the facility;

(c) The quantity of used antifreeze accepted by the facility for recycling during the previous year;

(d) The quantity of used antifreeze accepted by the facility for a purpose other than recycling and the disposition of that used antifreeze; and

(e) The calendar year which the report covers.

2. The report must be received by the Administrator on or before March 1 of the year after the period covered by the report.

(Added to NAC by Environmental Comm'n, eff. 10-3-96)

Mobile Units for Recycling

NAC 444.9051 Applicability. ([NRS 459.485](#)) The provisions of [NAC 444.9051](#) to [444.9071](#), inclusive, apply to an owner or operator of a mobile unit for the recycling of used antifreeze which recycles used antifreeze pursuant to a contract with a generator of used antifreeze.

(Added to NAC by Environmental Comm'n, eff. 10-3-96)

NAC 444.9056 Written determination. ([NRS 459.485](#)) An owner or operator of a mobile unit for the recycling of used antifreeze shall obtain a written determination from the Administrator pursuant to [NAC 444.8455](#) and [444.84555](#).

(Added to NAC by Environmental Comm'n, eff. 10-3-96)

NAC 444.9061 Records of used antifreeze accepted by mobile unit: Maintenance; contents. ([NRS 459.485](#), [459.550](#)) An owner or operator of a mobile unit for the recycling of used antifreeze shall maintain records of all used antifreeze accepted by the mobile unit for recycling. The records must be maintained for at least 3 years and be made available, upon request, for inspection by a representative of the Division. The records may be in the form of a log or copies of written contracts. The record for each shipment of used antifreeze accepted by the mobile unit for the purpose of recycling must include:

1. The name and address of the generator of used antifreeze;
2. The identification number of the generator, if he or she has an identification number;
3. The quantity of used antifreeze that is accepted by the mobile unit;
4. The date of acceptance of the used antifreeze; and
5. Upon completion of the contract, the date of completion and the signature of the representative of the owner or operator of the mobile unit.

(Added to NAC by Environmental Comm'n, eff. 10-3-96)

NAC 444.9066 Management of residue as hazardous waste. ([NRS 459.485](#))

1. Except as otherwise provided in subsection 2, an owner or operator of a mobile unit for the recycling of used antifreeze is responsible for the proper management, in accordance with [NAC 444.850](#) to [444.8746](#), inclusive, of residue of used antifreeze generated during the recycling or storage of the used antifreeze.

2. If recycling of used antifreeze occurs at the location where the used antifreeze was generated, the contract between the generator of used antifreeze and the owner or operator of the mobile unit which performs the recycling may specify that the generator is responsible for the proper management, in accordance with [NAC 444.850](#) to [444.8746](#), inclusive, of residue of used antifreeze generated during the recycling or storage of the used antifreeze.

(Added to NAC by Environmental Comm'n, eff. 10-3-96)

NAC 444.9071 Written report. ([NRS 459.485](#), [459.550](#))

1. An owner or operator of a mobile unit for the recycling of used antifreeze shall submit a written report to the Administrator which includes:

- (a) The name and address of the mobile unit;
- (b) The identification number issued to the mobile unit;
- (c) The quantity of used antifreeze accepted by the mobile unit for recycling during the previous year; and
- (d) The calendar year which the report covers.

2. The report must be received by the Administrator on or before March 1 of the year after the period covered by the report.

(Added to NAC by Environmental Comm'n, eff. 10-3-96)

POLYCHLORINATED BIPHENYL

NAC 444.940 Definitions. ([NRS 459.485](#)) As used in [NAC 444.940](#) to [444.9555](#), inclusive, unless the context otherwise requires, the words and terms defined in [NAC 444.9405](#) to [444.945](#), inclusive, have the meanings ascribed to them in those sections.

(Added to NAC by Environmental Comm'n, eff. 6-29-84; A 9-19-90)

NAC 444.9405 "Director" defined. ([NRS 459.485](#)) "Director" means the Administrator of the Division.

(Added to NAC by Environmental Comm'n, eff. 6-29-84)

NAC 444.941 "Disposal" defined. ([NRS 459.485](#)) "Disposal" has the meaning ascribed to it in 40 C.F.R. Part 761.3.

(Added to NAC by Environmental Comm'n, eff. 6-29-84; A 9-19-90)

NAC 444.9415 "Division" defined. ([NRS 459.485](#)) "Division" means the Division of Environmental Protection.

(Added to NAC by Environmental Comm'n, eff. 6-29-84)

NAC 444.942 "Draft permit" defined. ([NRS 459.485](#)) "Draft permit" means a document evidencing the proposed decision of the Director to issue, deny, modify, revoke, terminate or reissue a permit. The term includes a notice of intent to terminate a permit and a notice of intent to deny a permit.

(Added to NAC by Environmental Comm'n, eff. 6-29-84; A 9-19-90)

NAC 444.9425 "Facility for the management of waste containing polychlorinated biphenyl" defined. ([NRS 459.485](#)) "Facility for the management of waste containing polychlorinated biphenyl" includes the contiguous land and any structure, other appurtenances or improvements on the land which are used for treating, storing or disposing of waste containing polychlorinated biphenyls. Such a facility may contain several units for the treatment, storage or disposal of such waste.

(Added to NAC by Environmental Comm'n, eff. 6-29-84)

NAC 444.943 "Generator of polychlorinated biphenyl" defined. ([NRS 459.485](#)) "Generator of polychlorinated biphenyl" means any person who removes from service any item containing polychlorinated biphenyl, if such removal would require storage or disposal, or both, under 40 C.F.R. Part 761, Subpart B.

(Added to NAC by Environmental Comm'n, eff. 6-29-84; A 9-19-90)

NAC 444.9435 "Polychlorinated biphenyl" defined. ([NRS 459.485](#)) "Polychlorinated biphenyl" has the meaning ascribed to "PCB" in 40 C.F.R. Part 761.3.

(Added to NAC by Environmental Comm'n, eff. 6-29-84; A 9-19-90)

NAC 444.944 "Site" defined. ([NRS 459.485](#)) "Site" means the land or water where any facility for the management of waste containing polychlorinated biphenyl is located. The term includes any:

1. Adjacent land used in connection with the facility;
2. Geographically contiguous parcel which is owned by the same person but separated by a public or private right-of-way if access across the right-of-way is not along the right-of-way but across it; and
3. Noncontiguous property owned by the same person if the facility and the property are connected by a right-of-way controlled by the owner and to which public access is prohibited.

(Added to NAC by Environmental Comm'n, eff. 6-29-84)

NAC 444.9445 "Storage" defined. ([NRS 459.485](#)) "Storage" means temporary storage of waste containing polychlorinated biphenyl that has been designated for disposal.

(Added to NAC by Environmental Comm'n, eff. 6-29-84)

NAC 444.945 “Waste containing polychlorinated biphenyl” defined. (NRS 459.485) “Waste containing polychlorinated biphenyl” means any polychlorinated biphenyl or item containing polychlorinated biphenyl subject to regulation under 40 C.F.R. Part 761.

(Added to NAC by Environmental Comm’n, eff. 6-29-84; A 9-19-90)

NAC 444.9452 Adoption by reference of certain federal regulations. (NRS 459.485)

1. All sections, subparts and parts of Title 40 of the Code of Federal Regulations referred to in [NAC 444.940](#) to [444.9555](#), inclusive, as modified by [NAC 444.9453](#), are hereby adopted by reference as those sections, subparts and parts existed on July 1, 2008.

2. The volumes containing those sections, subparts and parts may be obtained by mail from the Superintendent of Documents, U.S. Government Printing Office, P.O. Box 979050, St. Louis, Missouri 63197-9000, or by toll-free telephone at (866) 512-1800, for the following prices:

(a) The volume containing 40 C.F.R. Parts 260 to 265,	\$53
inclusive.....	
(b) The volume containing 40 C.F.R. Parts 266 to 299,	50
inclusive.....	
(c) The volume containing 40 C.F.R. Parts 700 to 789,	64
inclusive.....	

(Added to NAC by Environmental Comm’n, eff. 9-19-90; A 11-9-95; R202-97, 3-5-98; R124-98, 11-2-98; R170-99, 1-26-2000; R037-01, 10-25-2001; R104-02, 10-18-2002; R126-03, 4-13-2004; R175-05, 5-4-2006; R137-07, 1-30-2008; R015-08, 4-17-2008; R153-08, 4-23-2009)

NAC 444.9453 References in federal regulations to “hazardous waste” and “hazardous waste facility.” (NRS 459.485)

1. Any references in any part of Title 40 of the Code of Federal Regulations to “hazardous waste” which have been adopted by reference pursuant to [NAC 444.9452](#) shall be deemed to mean “waste containing polychlorinated biphenyl.”

2. Any references in any part of Title 40 of the Code of Federal Regulations to “hazardous waste facility” which have been adopted by reference pursuant to [NAC 444.9452](#) shall be deemed to mean “polychlorinated biphenyl facility.”

(Added to NAC by Environmental Comm’n, eff. 9-19-90)

NAC 444.946 Generators: General duties. (NRS 459.485)

1. A generator of waste containing polychlorinated biphenyl shall not treat, store, dispose of, transport or offer for transportation any waste containing polychlorinated biphenyl without having received an identification number from the United States Environmental Protection Agency.

2. A generator of waste containing polychlorinated biphenyl shall mark his or her items as prescribed in 40 C.F.R. Part 761, Subpart C.

3. A generator of waste containing polychlorinated biphenyl who transports or offers for transportation waste containing polychlorinated biphenyl for treatment, storage or disposal at a place other than a site which is owned and operated by the generator shall prepare a manifest before transporting the waste. The manifest must be prepared and distributed in accordance with [NAC 444.8655](#) and 40 C.F.R. Part 262.42.

4. A generator of waste containing polychlorinated biphenyl shall retain a copy of the results of each test or analysis of waste containing polychlorinated biphenyl in accordance with 40 C.F.R. §§ 262.40(c) and 262.40(d).

5. A generator of waste containing polychlorinated biphenyl shall not offer the waste to transporters or to facilities for its treatment, storage or disposal that do not have an identification number or are not authorized to accept such waste.

(Added to NAC by Environmental Comm’n, eff. 6-29-84; A 9-19-90; 11-9-95)

NAC 444.9465 Transporters: General duties. (NRS 459.485)

1. A transporter of waste containing polychlorinated biphenyl shall not transport or accept for transportation any such waste without having received an identification number from the United States Environmental Protection Agency.

2. A transporter of waste containing polychlorinated biphenyl shall comply with the provisions of 40 C.F.R. §§ 263.20 to 263.22, inclusive.

(Added to NAC by Environmental Comm'n, eff. 6-29-84; A 9-19-90)

NAC 444.9475 Restrictions on management and treatment. ([NRS 459.485](#)) Waste containing polychlorinated biphenyl may not be managed in surface impoundments or waste piles and may not be treated or managed in soil.

(Added to NAC by Environmental Comm'n, eff. 6-29-84; A 9-19-90)

NAC 444.9485 Requirements for permit to operate or construct facility; requirements for permitted facility. ([NRS 459.485](#), [459.520](#))

1. Any facility to be constructed for the treatment, storage or disposal of waste containing polychlorinated biphenyl must have a permit before commencement of construction. The application for the permit must comply with the following sections of 40 C.F.R. Part 270:

- (a) Section 270.11;
- (b) Section 270.13, except for subsections (c), (f) and (j);
- (c) Section 270.14, except for subsections (a), (b)(2), (b)(6), (b)(9), (b)(11)(v), (b)(14), (b)(18) and (c)(1);
- (d) Section 270.15, except for subsections (c) and (d) and any reference to drainage systems in § 264.175;
- (e) Section 270.16;
- (f) Section 270.19; and
- (g) Section 270.21.

2. An application for a permit to operate or construct a facility for the treatment, storage or disposal of waste containing polychlorinated biphenyl must contain:

- (a) A specification and an estimate of the annual quantity of the waste containing polychlorinated biphenyl to be treated, stored or disposed of at the facility, designated by code number;
- (b) A description of the procedures and equipment required for the security of the facility;
- (c) A copy of the schedule for inspection;
- (d) A copy of the contingency plan;
- (e) A copy of the plan for the introductory and continuing training of personnel at the facility;
- (f) Proof of financial responsibility to ensure compliance with conditions of the permit as these requirements are specified in 40 C.F.R. §§ 264.140 to 264.148, inclusive; and
- (g) A copy of the plan for closure of the facility.

3. A generator of polychlorinated biphenyl who stores his or her own waste for less than 9 months or in quantities of less than 1,000 kilograms is not required to obtain a permit under this section.

4. The owner or operator of a permitted facility for the management of waste containing polychlorinated biphenyl shall comply with the conditions specified in 40 C.F.R. § 270.30.

(Added to NAC by Environmental Comm'n, eff. 6-29-84; A 9-19-90)

NAC 444.949 Director to prepare draft permit or deny application. ([NRS 459.485](#), [459.520](#))

1. When the Director receives a complete application for the management of waste containing polychlorinated biphenyl he or she shall prepare a draft permit or deny the application.

2. The Director shall include in each draft permit:

- (a) All conditions of the permit;
- (b) All schedules set for compliance; and
- (c) All requirements regarding the observation, detection and regulation of the facility.

3. If the Director decides to deny the application for a permit, the Director shall issue a notice of his or her intention to deny it.

4. If the Director's final decision is to withdraw the notice of intent to deny he or she shall prepare a draft permit.

(Added to NAC by Environmental Comm'n, eff. 6-29-84)

NAC 444.9495 Public notice. ([NRS 459.485](#), [459.520](#))

1. The Director shall give public notice that:
 - (a) An application for a permit for the management of waste containing polychlorinated biphenyl has been tentatively denied;
 - (b) A draft of such a permit has been prepared;
 - (c) A hearing concerning an application or permit has been scheduled; or
 - (d) An appeal from a decision concerning a permit has been granted.
 2. No public notice is required when a request for a modification, revocation, reissuance or termination of a permit is denied. The Director shall send the requester a brief written response containing a reason for the denial.
 3. The Director shall allow at least 45 days of public comment on a draft permit. The public notice of the preparation of a draft permit must specify the period allowed for public comment.
 4. Public notice of a hearing must be given at least 30 days before the hearing.
 5. All public notices must contain:
 - (a) The name and address of the Division;
 - (b) The name and address of the applicant for a permit or the holder of the permit and, if different, of the facility regulated by the permit;
 - (c) A brief description of the business conducted at the facility or activity described in the application or the draft permit;
 - (d) The name, address and telephone number of a person from whom interested persons may obtain further information, including copies of the draft permit and the application; and
 - (e) The time and place of any related hearing which is scheduled.
- (Added to NAC by Environmental Comm'n, eff. 6-29-84)

NAC 444.950 Public comment and hearings. ([NRS 459.485](#), [459.520](#))

1. During the period allowed for receipt of public comment and during any subsequent public hearing, any interested person may submit oral or written comments and data on the draft permit for the management of waste containing polychlorinated biphenyl.
 2. The Director may hold a public hearing if he or she receives:
 - (a) Written notice of opposition to a draft permit; and
 - (b) A request for a public hearing which is submitted to the Director within the period allowed for public comment.
 3. If a hearing concerns the location of a proposed facility, the Director shall, if possible, schedule the hearing at a place which is conveniently located in the center of population nearest the site of the proposed facility.
 4. The Director may set reasonable limits upon the time allowed for oral statements at the hearing and may require interested persons who make oral statements to submit those statements in writing.
 5. The Director may extend the period for receiving public comment by so stating at the hearing.
 6. The Director shall make available to the public a tape recording or written transcript of the hearing.
 7. Before the Director makes his or her final decision, the Director shall consider all comments which he or she has received.
- (Added to NAC by Environmental Comm'n, eff. 6-29-84)

NAC 444.9505 Final decision by Director. ([NRS 459.485](#), [459.520](#))

1. The Director shall issue a final decision regarding the issuance, denial, modification, revocation, reissuance or termination of a permit for the management of waste containing polychlorinated biphenyl after the close of the period set to receive public comment.
2. The Director shall notify the applicant of his or her decision and each person who has submitted written comments or requested notice of the final decision.
3. A final decision becomes effective 30 days after the service of notice of the decision unless:
 - (a) A later effective date is specified in the decision;
 - (b) Review is requested or a hearing for appeal is requested; or
 - (c) No comments requested a change in the draft permit, in which case the permit becomes effective

immediately upon issuance of the final decision.

(Added to NAC by Environmental Comm'n, eff. 6-29-84)

NAC 444.951 Requirements specified in permit. ([NRS 459.485](#), [459.520](#), [459.550](#)) The Director shall specify in each permit for the management of waste containing polychlorinated biphenyl:

1. Any requirements concerning the proper use, maintenance and installation of detecting equipment or methods used to observe or check the permitted activity;
2. Any required observation including the type, interval and frequency sufficient to yield data which are representative of the observed activity; and
3. Any applicable reporting requirements.

(Added to NAC by Environmental Comm'n, eff. 6-29-84)

NAC 444.9515 Transfer of permit. ([NRS 459.485](#), [459.520](#)) The holder of a permit may transfer his or her permit for the management of waste containing polychlorinated biphenyl to a new owner or operator if the permit has been modified by the Director to identify the new owner or operator and incorporate any other changes deemed necessary by the Director.

(Added to NAC by Environmental Comm'n, eff. 6-29-84; A 9-19-90)

NAC 444.952 Modification of permit; revocation and reissuance. ([NRS 459.485](#), [459.520](#))

1. The Director may modify a permit for the management of waste containing polychlorinated biphenyl if:

- (a) The holder files a request to make substantial alterations, additions or changes to the facility or activity after issuance of the permit;
- (b) The Director has received information which was not available at the time the permit was issued and which would have justified the imposition of different conditions upon the holder of the permit;
- (c) The standards or regulations on which the permit was based have been changed by amendment or by judicial decision after the permit was issued;
- (d) The Director determines that good cause exists for modification of a schedule for compliance, such as a strike, a shortage of materials, a flood or other act of God, or some other event over which the holder has little or no control and for which there is no reasonably available remedy;
- (e) The Director receives new information that the facility in its existing location constitutes a threat to human health or the environment;
- (f) The holder files a request for a variance from the level of required financial responsibility or the Director finds that an adjustment of the level of financial responsibility is necessary;
- (g) The Director has received notification of a proposed transfer of the permit;
- (h) One of the causes set forth in [NAC 444.9525](#) exists for the termination of a permit and the Director determines that modification or revocation and reissuance is appropriate; or
- (i) The Director determines that:
 - (1) Extension and modification of the time for closing the facility;
 - (2) Continuation of requirements for security at the facility; or
 - (3) Disturbing the integrity of the system for containment of waste at the facility,

Ê is unwarranted.

2. Each request from an interested person, including the holder of the permit, for a modification or a revocation and reissuance of a permit must be in writing and contain facts or reasons supporting the request.

3. If the Director decides to modify a permit or to revoke and reissue it, he or she shall prepare a draft permit incorporating the proposed changes.

4. In the case of:

- (a) A revoked and reissued permit, the owner or operator must submit a new application.
- (b) A modified permit, the Director may require the owner or operator to submit an updated application.

5. The Director may request additional information from the owner or operator as needed.

6. When a permit is modified, only those conditions to be modified may be considered when a new draft of a permit is prepared. All other aspects of the existing permit must remain in effect for the duration of the unmodified portion of the permit.

7. When a permit is revoked and reissued, the entire subject of the permit may be considered, as if the permit had expired and was being reissued. During any procedure for revocation and reissuance, the holder shall comply with all conditions of the existing permit until a final permit is reissued.

(Added to NAC by Environmental Comm'n, eff. 6-29-84; A 9-19-90)

NAC 444.9525 Notice of intent to terminate permit. (NRS 459.485, 459.520) When the Director decides to terminate a permit for the management of waste containing polychlorinated biphenyl the Director shall issue a notice of his or her intent to terminate and follow the same procedure as for a draft permit. The following are causes for terminating a permit during its term or for denying renewal:

1. Noncompliance by the permittee with any condition of the permit;
2. The permittee's misrepresentation or failure to disclose fully all relevant facts; or
3. A determination by the Director that the permitted activity endangers human health or the environment and can only be returned to acceptable levels by modification or termination.

(Added to NAC by Environmental Comm'n, eff. 6-29-84)

NAC 444.953 Emergency permits. (NRS 459.485, 459.520)

1. If the Director finds an imminent and substantial endangerment to human health or the environment he or she may issue an emergency permit for the management of waste containing polychlorinated biphenyl to a nonpermitted facility to allow the storage of waste containing polychlorinated biphenyl for a period which does not exceed 90 days.

2. The emergency permit may be:

(a) Oral or written. If oral, the Director shall issue a written emergency permit within 5 days after the oral permission is given; and

(b) Terminated by the Director at any time to protect human health or the environment.

3. The Director shall clearly specify the manner and location of storage.

4. The permit must incorporate all applicable requirements of this chapter to the extent possible and not inconsistent with the emergency.

(Added to NAC by Environmental Comm'n, eff. 6-29-84)

NAC 444.9535 Notice of planned alterations or additions. (NRS 459.485, 459.520)

1. The permittee shall give notice to the Director as soon as possible of any planned physical alterations or additions to the permitted facility for the management of waste containing polychlorinated biphenyl. The permittee shall not commence treatment, storage or disposal of waste containing polychlorinated biphenyl in an altered facility until:

(a) The permit has been modified in accordance with [NAC 444.952](#);

(b) The permittee has submitted to the Director by certified mail or hand delivery a letter signed by the permittee and a licensed professional engineer stating that the facility has been modified or the addition has been constructed in compliance with the permit; and

(c) Except as otherwise provided in subsection 2, the Director has inspected the modified or newly constructed facility and finds it is in compliance with the conditions of the permit.

2. If within 15 days after the date of submission of the letter required in subsection 1 the permittee has not received notice from the Director of his or her intent to inspect, the inspection is waived and the permittee may commence treatment, storage or disposal of waste containing polychlorinated biphenyl.

3. The permittee shall give advance notice to the Director of any planned changes in the permitted facility or activity which may result in noncompliance with the permit.

(Added to NAC by Environmental Comm'n, eff. 6-29-84)

NAC 444.954 Report of noncompliance. (NRS 459.485, 459.550)

1. The permittee of the facility for the management of waste containing polychlorinated biphenyl shall report to the Director any noncompliance which may endanger public health or the environment.

2. Within 24 hours after the time the permittee becomes aware of the noncompliance he or she shall orally provide:

(a) Information concerning the release of any waste containing polychlorinated biphenyl that may cause

an endangerment to a public supply of drinking water; and

(b) Any information regarding a discharge of waste containing polychlorinated biphenyl or a fire or explosion from a facility which could threaten the environment or human health outside the facility. The permittee shall include:

- (1) The name, address and telephone number of the operator;
- (2) The name, address and telephone number of the facility;
- (3) The date, time and type of the incident;
- (4) The name and quantity of material involved;
- (5) The extent of any injuries;

(6) An assessment of any actual or potential hazards to the environment and human health outside the facility; and

(7) The estimated quantity and disposition of any recovered material that resulted from the incident.

3. The permittee shall submit a written report to the Director within 5 days after the time the permittee becomes aware of any noncompliance which may endanger public health or the environment which includes:

- (a) The information required in subsection 2;
- (b) A description of the noncompliance and its cause;
- (c) The period of noncompliance, including the exact dates and times;
- (d) The anticipated time the noncompliance is expected to continue; and
- (e) The steps planned or taken to reduce, eliminate and prevent a reoccurrence of the noncompliance.

4. The Director may, upon a reasonable request, extend to 15 days the period allowed for the submission of the written report.

(Added to NAC by Environmental Comm'n, eff. 6-29-84)

NAC 444.9545 Completion or correction of application or report. ([NRS 459.485](#), [459.520](#), [459.550](#)) When the facility permittee becomes aware that he or she:

1. Failed to submit any relevant facts in an application for a permit; or

2. Submitted incorrect information in an application for a permit or in any report to the Director, he or she shall promptly submit the facts or corrected information to the Director.

(Added to NAC by Environmental Comm'n, eff. 6-29-84)

NAC 444.955 Minor modifications to permit. ([NRS 459.485](#), [459.520](#), [459.550](#)) The Director may make minor modifications to a permit for the management of waste containing polychlorinated biphenyl with the consent of the permittee. For the purposes of this section, minor modifications may:

1. Correct typographical errors;

2. Require more frequent checking or reporting by the permittee;

3. Allow for a change in ownership or operational control of a facility where the Director determines that no other change in the permit is necessary, provided that a written agreement containing a specific date for transfer of responsibility, coverage and liability between the current and new permittees has been submitted to the Director; or

4. Change the lists of the facility's emergency coordinators or equipment in the permit's plan for contingency.

(Added to NAC by Environmental Comm'n, eff. 6-29-84)

NAC 444.9555 Facilities to obtain identification number; compliance with regulations. ([NRS 459.485](#), [459.520](#))

1. A facility for the management of waste containing polychlorinated biphenyl shall obtain an identification number from the United States Environmental Protection Agency and comply with the requirements of 40 C.F.R. Part 761, Subpart D.

2. A facility for the management of waste containing polychlorinated biphenyl which is required to obtain a permit as specified in [NAC 444.9485](#) shall also comply with the following:

(a) 40 C.F.R. § 264.12;

(b) 40 C.F.R. § 264.13;

(c) 40 C.F.R. §§ 264.14 to 264.16, inclusive;

- (d) 40 C.F.R. §§ 264.31 to 264.37, inclusive;
 - (e) 40 C.F.R. §§ 264.51 to 264.56, inclusive;
 - (f) 40 C.F.R. §§ 264.72 to 264.74, inclusive;
 - (g) 40 C.F.R. § 264.76;
 - (h) 40 C.F.R. §§ 264.77(a) and 264.77(b);
 - (i) 40 C.F.R. §§ 264.111 to 264.120, inclusive;
 - (j) 40 C.F.R. §§ 264.140 to 264.148, inclusive;
 - (k) 40 C.F.R. §§ 264.171 to 264.175, inclusive;
 - (l) 40 C.F.R. § 264.178; and
 - (m) 40 C.F.R. Part 264, Subparts J, N and O.
- (Added to NAC by Environmental Comm'n, eff. 6-29-84; A 4-18-90; 9-19-90)

LIMITATIONS ON ISSUANCE OF PERMITS

NAC 444.960 Reliability, expertise and competence required; issuance prohibited if person having beneficial interest convicted of felony. ([NRS 459.485](#), [459.520](#))

1. A person may be issued a permit to operate a facility for the management of hazardous waste or facility for the management of waste containing polychlorinated biphenyl only if the Administrator of the Division of Environmental Protection is satisfied that he or she has exhibited sufficient reliability, expertise and competence in the management of waste or a related field to operate the facility with a minimal risk to the health of humans or to the environment.

2. The Administrator shall not issue a permit if any person shown to have a beneficial interest in the facility has been convicted of a felony.

3. As used in this section:

(a) "Facility for the management of hazardous waste" includes the contiguous land and any structures, other appurtenances or improvements on the land which are used for treating, storing or disposing of hazardous waste. Such a facility may contain several units for the treatment, storage or disposal of hazardous waste or a combination of such units.

(b) "Facility for the management of waste containing polychlorinated biphenyl" has the meaning ascribed to it in [NAC 444.9425](#).

(Added to NAC by Environmental Comm'n, eff. 10-16-85; A 9-19-90)

DISPOSAL OF ASBESTOS

NAC 444.965 Definitions. ([NRS 618.775](#)) As used in [NAC 444.965](#) to [444.976](#), inclusive, unless the context otherwise requires, the words and terms defined in [NAC 444.966](#) to [444.970](#), inclusive, have the meanings ascribed to them in those sections.

(Added to NAC by Environmental Comm'n, eff. 12-19-89)

NAC 444.966 "Asbestos" defined. ([NRS 618.775](#)) "Asbestos" has the meaning ascribed to it in [NRS 618.750](#).

(Added to NAC by Environmental Comm'n, eff. 12-19-89)

NAC 444.967 "Division" defined. ([NRS 618.775](#)) "Division" means the Division of Environmental Protection of the State Department of Conservation and Natural Resources.

(Added to NAC by Environmental Comm'n, eff. 12-19-89)

NAC 444.968 "Operator" defined. ([NRS 618.775](#)) "Operator" means a person who operates a Class I disposal site which has been approved by the solid waste management authority.

(Added to NAC by Environmental Comm'n, eff. 12-19-89)

NAC 444.969 "Solid waste management authority" defined. ([NRS 618.775](#)) "Solid waste management authority" means the officers and agents of the Division of Environmental Protection, any

district board of health created pursuant to [NRS 439.370](#) or any other entity given specific authority by the Division to control asbestos.

(Added to NAC by Environmental Comm'n, eff. 12-19-89; A 11-8-93)

NAC 444.970 "Transporter" defined. ([NRS 618.775](#)) "Transporter" means a person engaged in the transportation of asbestos by air, rail, highway or water. The term does not include any person engaged in such transportation on an approved Class I disposal site.

(Added to NAC by Environmental Comm'n, eff. 12-19-89)

NAC 444.971 Standards for handling and transportation. ([NRS 618.775](#))

1. All asbestos that is friable or otherwise capable of giving off friable asbestos dust and that is intended for transport must be wetted with a water and surfactant mixture and stored in:

- (a) A plastic bag which is not less than 6 mils thick and sealed so it will not leak;
- (b) A combination of plastic bags which equal at least 6 mils in thickness; or
- (c) A container made of cardboard or metal which is lined with plastic.

2. Each container used to dispose asbestos must bear a label that conforms with the requirements of the United States Environmental Protection Agency or Occupational Safety and Health Act and contains either of the following statements:

CAUTION
CONTAINS ASBESTOS FIBERS
AVOID OPENING OR BREAKING CONTAINER
BREATHING ASBESTOS IS HAZARDOUS TO YOUR HEALTH
or
CAUTION
CONTAINS ASBESTOS FIBERS
AVOID CREATING DUST
MAY CAUSE SERIOUS BODILY HARM
or
DANGER
CONTAINS ASBESTOS FIBERS
AVOID CREATING DUST
CANCER AND LUNG DISEASE HAZARD

3. The vehicle used to transport asbestos must be fully enclosed or be covered so as to prevent damage to the containers or the release of asbestos fibers.

(Added to NAC by Environmental Comm'n, eff. 12-19-89)

NAC 444.972 Approval required for transportation; submission of information to obtain approval. ([NRS 618.775](#))

1. Before a transporter may transport asbestos, he or she must obtain the written approval of the solid waste management authority.

2. A transporter who seeks approval to transport asbestos shall submit the following information in writing:

- (a) The name, address and license number of the transporter and any subcontractor;
- (b) The address and description of the place from which the asbestos is collected;
- (c) The projected starting and completion dates for transportation and disposal of the asbestos;
- (d) The procedure which will be used to comply with [NAC 444.965](#) to [444.976](#), inclusive, concerning the transportation and disposal of the asbestos; and
- (e) The name and address of the site where the asbestos will be disposed of.

(Added to NAC by Environmental Comm'n, eff. 12-19-89)

NAC 444.973 Maintenance and filing of records regarding transportation. ([NRS 618.775](#))

1. A transporter shall maintain a written record containing the following information regarding each load of asbestos he or she transports to a Class I disposal site:
 - (a) A number identifying the record;
 - (b) The name and location of the place where the asbestos is located;
 - (c) The name, mailing address and telephone number of the generator;
 - (d) The name, mailing address and telephone number of the transporter;
 - (e) The name, mailing address and telephone number of the disposal site;
 - (f) A description of the asbestos, the number of containers and the volume or weight of each container;
 and
 - (g) A certification of the containers and labels of the generator.
2. The record must:
 - (a) Be maintained each time the transporter transports asbestos to a disposal site on the form prescribed by the Division;
 - (b) Contain a signature line for the generator, transporter and operator; and
 - (c) Contain a space for comments.
3. For the purposes of [NAC 444.965](#) to [444.976](#), inclusive, the transporter shall be deemed the generator.
4. The transporter shall file a copy of his or her record with the solid waste management authority within 30 days after the asbestos has been delivered to the disposal site. The transporter shall keep each record for at least 3 years after the asbestos has been delivered to the disposal site.
5. As used in this section:
 - (a) "Asbestos-containing waste material" means any:
 - (1) Waste substance that contains more than 1 percent asbestos and is generated as a result of a project for the abatement of asbestos; or
 - (2) Clothing, equipment or other material contaminated with asbestos as a result of such a project.
 - (b) "Generator" means any person whose act or process produces asbestos or asbestos-containing waste material.
 (Added to NAC by Environmental Comm'n, eff. 12-19-89)

NAC 444.974 Notification required before delivery; disposal at site other than Class I disposal site. ([NRS 618.775](#))

1. Each transporter shall notify the operator at least 24 hours before delivery of the asbestos.
 2. Asbestos may be disposed of at a site other than a Class I disposal site if such disposal is approved by the solid waste management authority.
- (Added to NAC by Environmental Comm'n, eff. 12-19-89)

NAC 444.975 Inspection upon delivery; notice of noncompliance with standards; acceptance of noncomplying load. ([NRS 618.775](#))

1. Each operator who accepts asbestos shall inspect each load to verify that each container and label complies with the requirements prescribed in [NAC 444.971](#). If there is any noncompliance with those requirements which may cause the release of fibers during disposal, the operator shall notify the solid waste management authority.
 2. If the operator notifies the solid waste management authority of noncompliance and the authority authorizes the operator to accept the asbestos, the operator shall comply with the requirements set forth in paragraphs (e), (f) and (g) of subsection 1 of [NAC 444.976](#).
- (Added to NAC by Environmental Comm'n, eff. 12-19-89)

NAC 444.976 Duties of operator who accepts asbestos. ([NRS 618.775](#))

1. Each operator who accepts asbestos shall:
 - (a) Designate a separate area of the disposal site for asbestos;
 - (b) Maintain records of the location and quantity of asbestos which he or she accepts;
 - (c) Place each container in a landfill in a manner that limits breakage;
 - (d) Cover asbestos within 24 hours after placement with at least 6 inches of material that is not asbestos;
 - (e) Soak any asbestos which is in a container that does not comply with the requirements of [NAC 444.971](#)

before unloading it;

(f) Rinse out any vehicle which contained any asbestos which is in a container that does not comply with the requirements of [NAC 444.971](#);

(g) Immediately cover any asbestos which is in a container that does not comply with the requirements of [NAC 444.971](#);

(h) Compact asbestos after it is covered as prescribed in paragraph (d);

(i) Cover asbestos with at least 30 inches of compacted material that is not asbestos after the area designated for the disposal of asbestos is no longer used;

(j) Grade and stabilize the material which covers asbestos;

(k) Control access to any area where asbestos is disposed of; and

(l) Place a sign at each point of access to the site which reads:

ASBESTOS WASTE DISPOSAL SITE
BREATHING ASBESTOS DUST
MAY CAUSE LUNG DISEASE AND CANCER
or
DANGER
CONTAINS ASBESTOS FIBERS
AVOID CREATING DUST
CANCER AND LUNG DISEASE HAZARD

2. As used in this section, "landfill" means a facility or part of a facility at which asbestos is disposed of by placing it into or on land.

(Added to NAC by Environmental Comm'n, eff. 12-19-89)

PRACTICE BEFORE STATE ENVIRONMENTAL COMMISSION

NAC 444.980 Appeal of final decision of State Department of Conservation and Natural Resources. ([NRS 233B.050](#), [444.560](#), [459.485](#))

1. Except as otherwise provided in subsection 2, any person who requests a hearing before the State Environmental Commission concerning a final decision of the State Department of Conservation and Natural Resources pursuant to [chapter 444](#) of NRS may do so by filing a request, within 10 days of notice of the action of the Department on Form 3* with the State Environmental Commission, Bryan State Office Building, 901 South Stewart Street, Carson City, Nevada 89701-5249.

2. A decision of the Department issued pursuant to [NAC 444.8701](#) to [444.8746](#), inclusive, is a final decision for the purposes of judicial review.

3. The provisions of [NAC 445B.875](#) to [445B.899](#), inclusive, apply to a hearing of the State Environmental Commission requested pursuant to subsection 1.

*(See adopting agency for form.)

(Added to NAC by Environmental Comm'n, eff. 10-29-93; A by R015-08, 4-17-2008)