

AquaPure[®] and PureLink[™] Tri-Sensor Replacement Kits

WARNING

FOR YOUR SAFETY - This product must be installed and serviced by a contractor who is licensed and qualified in pool equipment by the jurisdiction in which the product will be installed where such state or local requirements exists. In the event no such state or local requirement exists, the maintainer must be a professional with sufficient experience in pool equipment installation and maintenance so that all of the instructions in this manual can be followed exactly. Before installing this product, read and follow all warning notices and instructions that accompany this product. Failure to follow warning notices and instructions may result in property damage, personal injury, or death. Improper installation and/or operation will void the warranty. Improper installation and/or operation can create unwanted electrical hazard which can cause serious injury, property damage, or death.

WARNING

If the information in these instructions is not followed exactly, a fire or explosion may result causing property damage, personal injury or death.

These instructions are to be used with the following:

R0452500 -- Chlorine Generator Cell Port Sensor Installation Kit

R0476400 -- Chlorine Generator Cell Port Sensor Installation Kit

R0403700 -- Flow Sensor Installation Kit

R0403800 -- Flow Sensor Installation Kit

To avoid any shock hazards and to ensure your safety, follow these instructions precisely.

Before starting, use the parts lists at the back of these instructions to identify the parts that are in your kit. If any parts are missing, please call your local Zodiac distributor. For technical assistance, call Zodiac Technical Support at 1.800.822.7933.

A. Installation of Tri-Sensor Assembly

WARNING

ELECTRICAL SHOCK HAZARD



Turn off all switches and the main breaker in the pool/spa electrical circuit before starting the installation or replacement procedure. Failure to comply may cause a shock hazard resulting in severe personal injury or death.

All wiring must be done in accordance with the National Electrical Code[®] (NEC[®]), NFPA-70. In Canada, the Canadian Electrical Code (CEC), CSA C22.1, must be followed. All applicable local installation codes and regulations must be followed.

1. Turn OFF power to AquaPure/PureLink[™] systems and circulation pump.
2. Open power center door and remove the two (2) outer screws of panel assembly. Fold down panel assembly on its hinge to access chlorine generator power interface board. See Figure 2.
3. Disconnect and remove the existing Tri-Sensor assembly.
4. Insert the new female connector from the Tri-Sensor cable through the bottom of the power center enclosure. The Sensor Interface Module will remain outside & below the power center as shown in Figure 2.
5. Connect the female connector from the Tri-Sensor into the mating connector on the power interface board (Figure 4) or AKC Front Board (Figure 5).
6. Install cable tie for strain relief as shown in figure 3.
7. Re-attach the PureLink User Interface to the Power Center using the screws removed in step 2.

8. Secure PureLink User Interface panel assembly to Power Center using the two (2) screws removed in step 2.
9. Turn ON power to AquaPure/PureLink systems and circulation pump.
10. Proceed to SECTION B: FIRMWARE IDENTIFICATION.

B. Identify AquaPure Firmware Version

1. At the same time, press ,  and  on the AquaPure User Interface. See Figure 1.

NOTE The first four pairs of digits that flash on the AquaPure User Interface screen is the firmware revision. See Figure 1.

2. Press  to resume normal operation.
Use the space below to record the firmware version:

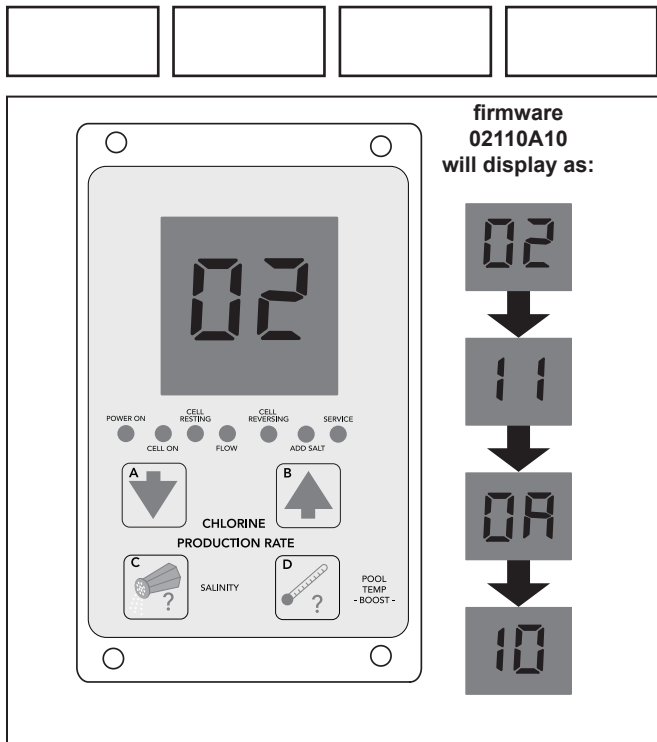

Figure 1. AquaPure User Interface

C. Firmware Selection

On the Interface module, there are three LED's: one indicating flow, and two indicating firmware programs A & B.

1. Ensure there is power to the tri-sensor interface module. Either PGM A or PGM B must be illuminated before proceeding. If neither is illuminated, there is no power to the Tri-Sensor.

2. If the power interface board firmware is 02110A10 as determined in Section B, 'PGM A' should be lit before proceeding to section D: CONFIRMATION OPERATION. If "PGM B" is lit, proceed to step 4.
3. For all other firmwares and AKC13 Front Boards (See Figure 5)"PGM B" should be lit before proceeding to section D: CONFIRMATION OPERATION. If "PGM A" is lit, proceed to step 4.
4. On the Interface Module press and hold "SEL" button until the desired program is selected, then release the "SEL" button.

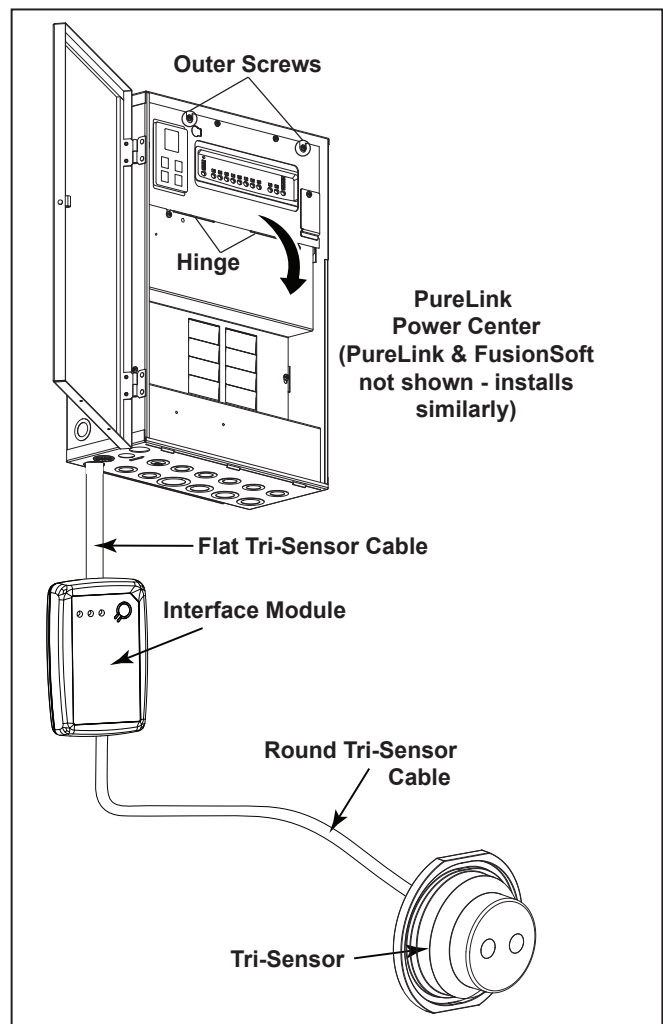

Figure 2. PureLink Power Center Enclosure

D. Confirm Operation

1. Confirm that either Pgm A or Pgm B is illuminated.
2. With pump running, confirm the Sensor Flow indicator is illuminated. This may take up to 5 minutes.

3. Within 2 minutes of the Sensor Flow indicator illuminated on the Tri-Sensor Interface Module, ensure that the AquaPure User Interface indicates flow.
4. If the AquaPure User Interface indicates flow, installation is now complete. If it does not, ensure that the correct program (A or B) is selected and change it if necessary as explained in section C, step 4.

E. Components of the Installation Kit, P/N R0452500

The following table is for your reference. To order additional parts, please contact your local Zodiac distributor.

	DESCRIPTION	QTY
1	Tri-Sensor Assembly	1
2	Installation Instructions	1
3	Plastic Cable Ties for Strain Relief	2

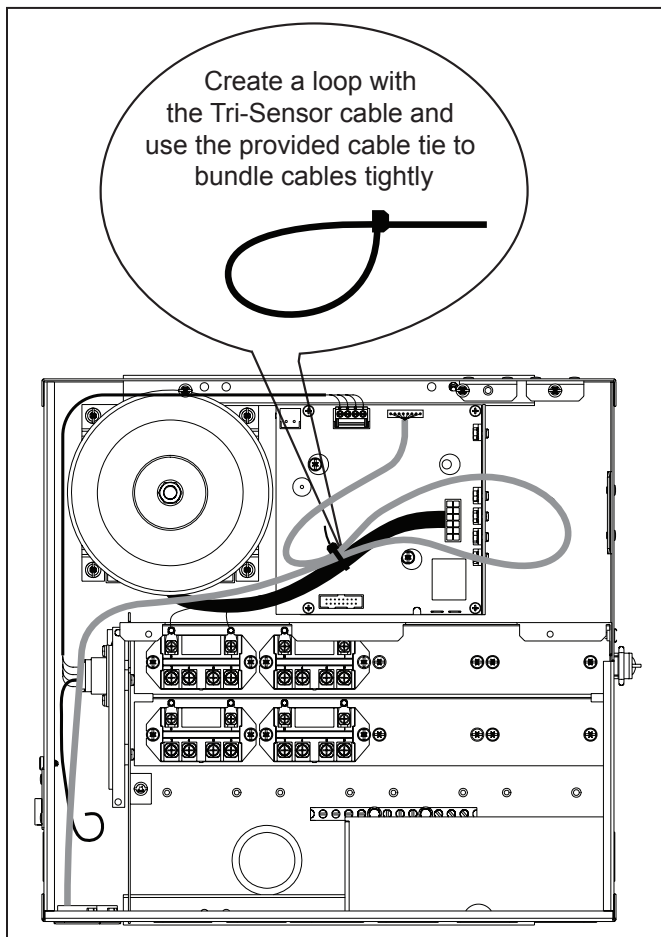

Figure 3. Cable Tie Installation for strain relief

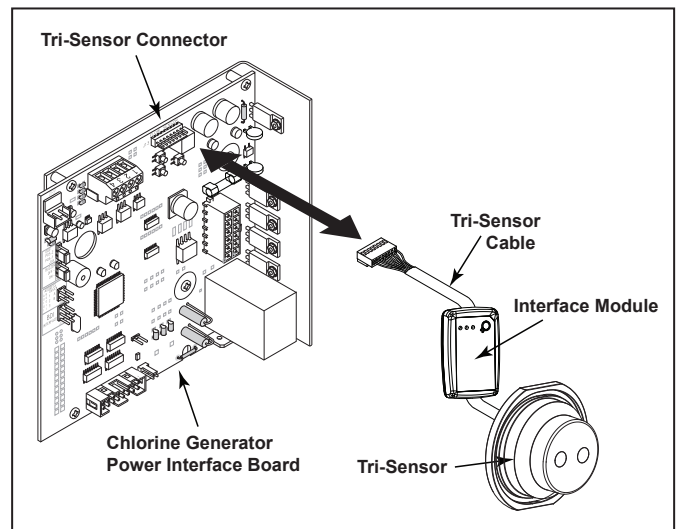

Figure 4. Installation on a late generation Power Interface Board. For installation with an AKC13 Front Board, see Figure 5.

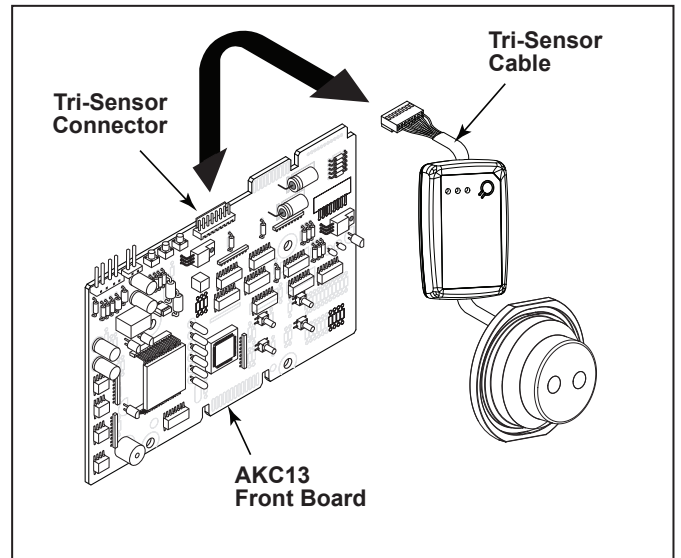

Figure 5. Tri-Sensor installation on an AKC13 Front Board

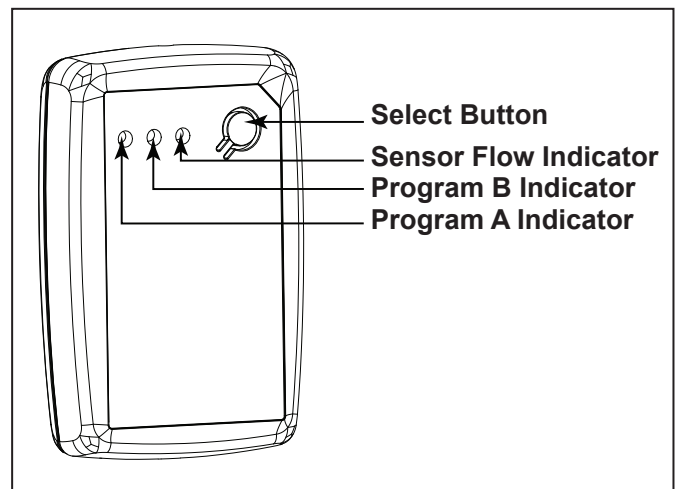

Figure 6. Tri-Sensor Interface Module

Zodiac Pool Systems, Inc.
2620 Commerce Way, Vista, CA 92081
1.800.822.7933 | www.ZodiacPoolSystems.com

*ZODIAC® is a registered trademark of Zodiac International, S.A.S.U., used under license.
All trademarks referenced herein are the property of their respective owners.*

©2014 Zodiac Pool Systems, Inc. H0425400 Rev C

