

**HANDRAIL SERIES
MODEL - 3 BEND STAIR RAIL 72"**

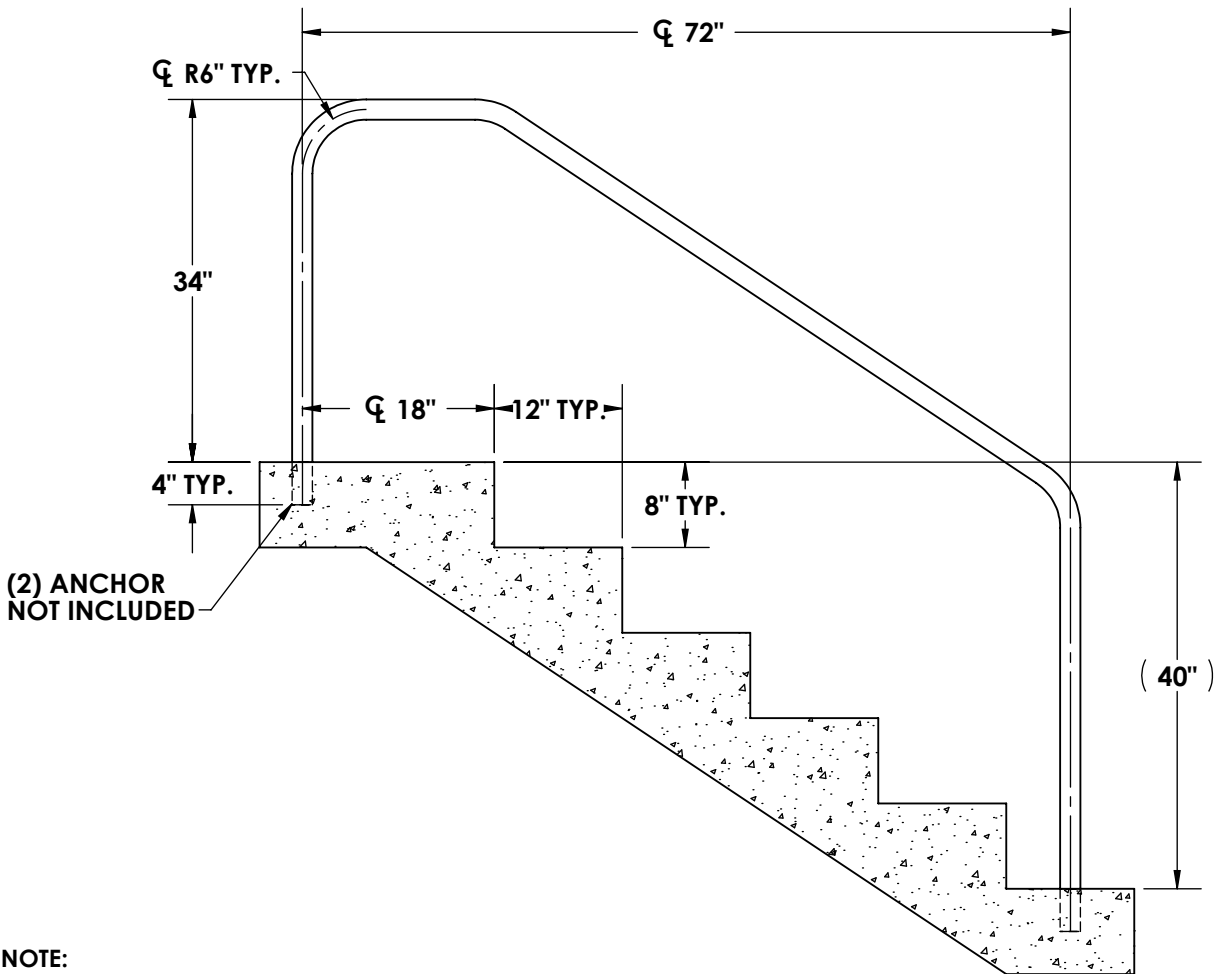

NOTE:

1 DIMENSIONS VARY WITH SPECIFIC APPLICATIONS.

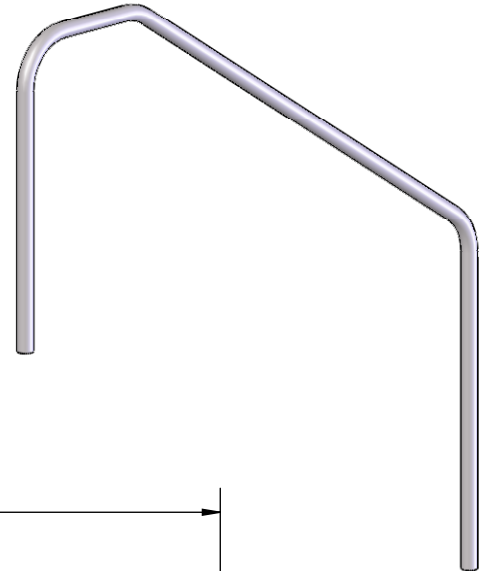

7100 Spectrum Lane
Missoula, Montana 59808
406.542.9781 * 800.791.8056
Fax: 406.542.1158
www.spectrumproducts.com

ENGINEERING DATA

PRODUCT:	3 BEND STAIR RAIL 72"
PRODUCT #:	35013-.109
REVISION:	A
MATERIAL:	300 SERIES STAINLESS STEEL