

SPECK X pumps

High-performance design ...



BADU[®] Block Multi Series **Normblock Multi Series**

All Plastic Commercial Pool Pump 1750 RPM

BADU® Block Multi Series Normblock Multi Series

QUIET & EFFICIENT SUPERIOR DESIGN

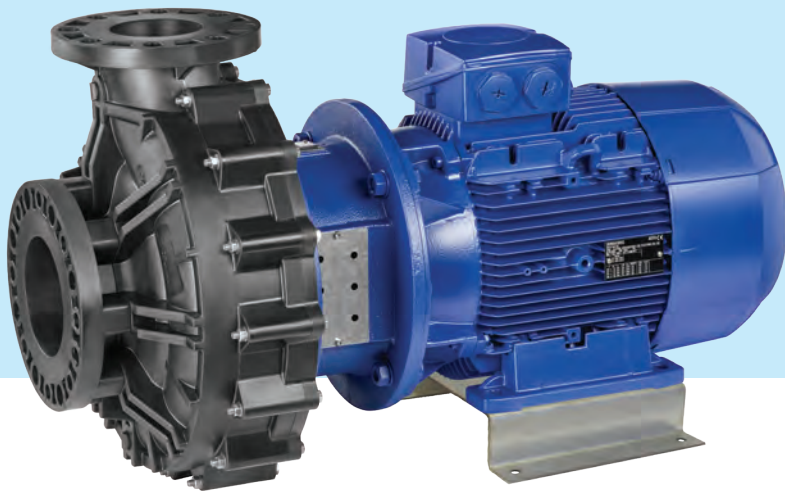

Normblock Multi Series (7.5 up to 30 HP)

DESIGN

This pump has a robust horizontal single stage design.

APPLICATION

Ideally suited for aquatic facilities, fountains, water parks, cruise ships and pools with elevated salt concentration. Perfect for aquaculture.

Optional all plastic strainer tank for horizontal flooded suction applications



BADU Block Multi Series (7.5 up to 30 HP)

DESIGN

- This pump has a vertical design that creates impressive performance while saving space thereby reducing construction costs.
- All plastic strainer tank with stainless steel basket. Optional plastic basket and plastic air bleed available for fish farming and aquaculture with higher salt concentration.
- Each pump is equipped with outside circulation and air bleed line that extends the life of the mechanical seal.

APPLICATION

Ideally suited for aquatic facilities, fountains, water parks, cruise ships and pools with elevated salt concentration. Perfect for aquaculture.

Please note: Both horizontal and vertical pumps are for flooded suction applications only.

BADU® Block & Normblock Multi 125/250

1750 RPM (20 HP, 25 HP, 30 HP)

SPECK

The most powerful plastic pool pumps in America ...

Introducing the latest additions to our all plastic commercial pool pump line ... the **BADU Block 125/250** and the **Normblock Multi 125/250**. With a durable plastic housing and power up to 30 HP, you can expect superior performance, dependable operation and long life.

What You Want, When You Need It

Our all-plastic production line has allowed us to dramatically cut lead times. By assembling, testing, and stocking our pumps in the U.S., we typically ship in just days instead of weeks.

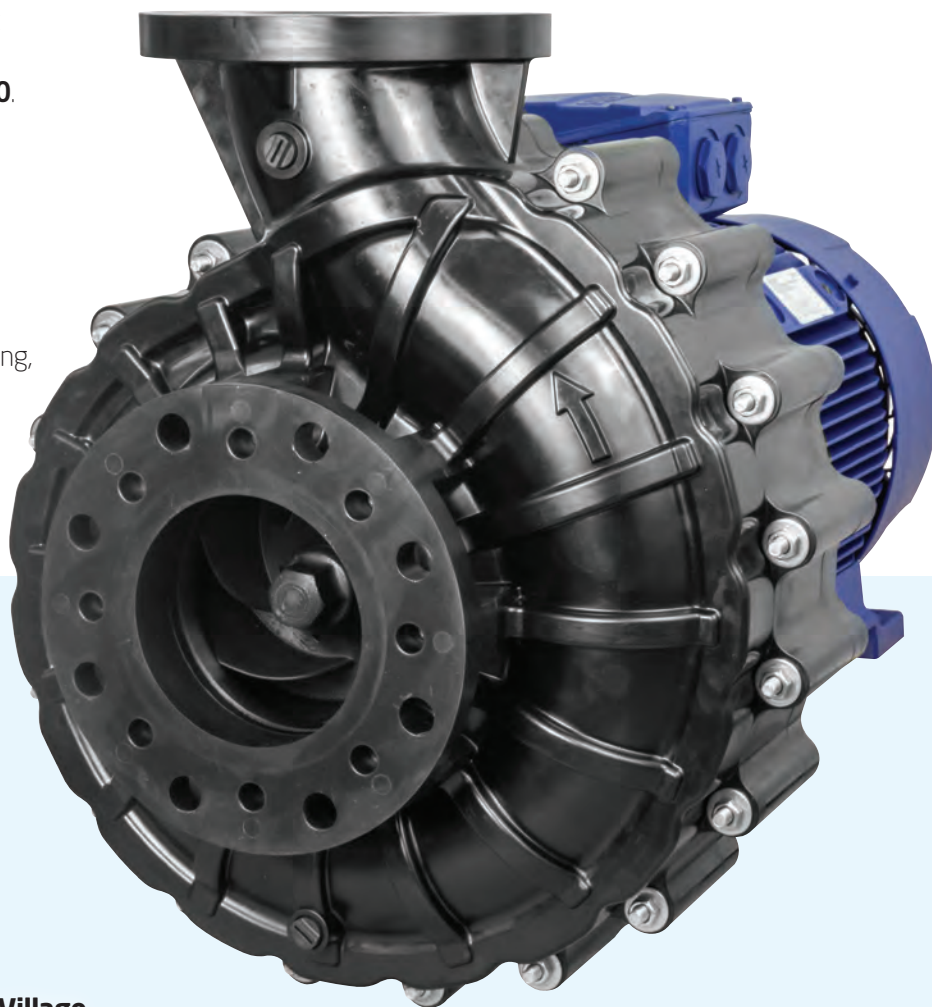

A Sampling of Speck Commercial Installations on Pools & Fountains Around the World

Metropolitan Museum of Art Fountain

New York City, New York USA
Fountains

Crystal Lagoons

Nocatee, Florida USA
Swimming Pool

AT&T Discovery Plaza

McKinney, Texas USA
Fountain

Frisco Natatorium

Frisco, Texas USA
Competition Pool

Four Seasons Hotel

Orlando, Florida USA
Waterfall

Santa's Village Azoosment Park

East Dundee, Illinois USA
Waterslides

Nashville Zoo

Nashville, TN USA
Animals Exhibit

Sandals Resort

Ocho Rios, Jamaica
Swimming Pool

Aquacentrum

Hradec, Czech Republic
Swimming Pool

Vogesenplatz

Basel, Switzerland
Fountain

Theresienbad

Vienna, Austria
Swimming Pool

CNI Les Thermes

Strassen, Luxembourg
Swimming Pool

Aqua Park

Kfar, Israel
Swimming Pool

Burgers' Zoo

Arnhem, Netherlands
Animals Exhibits

Tierpark Hagenbeck

Hamburg, Germany
Artic Animals Exhibits

The German-engineered BADU® Block Multi Series and Normblock Multi Series pumps are designed to run at 1750 rpm providing efficient, quiet operation.

The new all-plastic housing is corrosion resistant, delivering long life and dependable performance ... hallmarks of Speck Pumps technology.

BADU Block is equipped with outside circulation and air bleed line that extends the life of the mechanical seal.

Heavy-duty energy efficient totally enclosed fan cooled (TEFC) motor, Class F insulation, protection class IP 55. Sealed ball bearings need no lubrication.

Stainless steel shaft extension

Carbon/SiC-EPDM mechanical seal

The housing and impeller are made of high performance plastic (THK), corrosion resistant without elaborate internal coating and can be used with higher salt concentrations.

FEATURES

- Superior slow (1750 rpm) running design reduces vibrations resulting in quiet operation.
- On BADU Block Multi models the discharge can be rotated freely (a major advantage at the construction site).
- The motor can be replaced without disassembling the pump. This design allows for the mechanical seal to remain in place.
- A wear-resistant and rugged Carbon/SiC-EPDM mechanical seal allows for a long life and long maintenance intervals.
- The pump comes with a full 12 month warranty.
- Every pump is tested to factory & customer's specifications.

Please Note: The noise level from both the motor and pump is greatly influenced by how they are installed. Consideration should be given to minimize vibration and noise transmission.

Optional integrated NEMA 4X Speck/Vacon X5



Optional Ceramic Coated Cast Iron Strainer Tank

PERFORMANCE CURVES



BADU Block & Normblock Multi Series (7.5 HP, 10 HP, 15 HP, 20 HP)

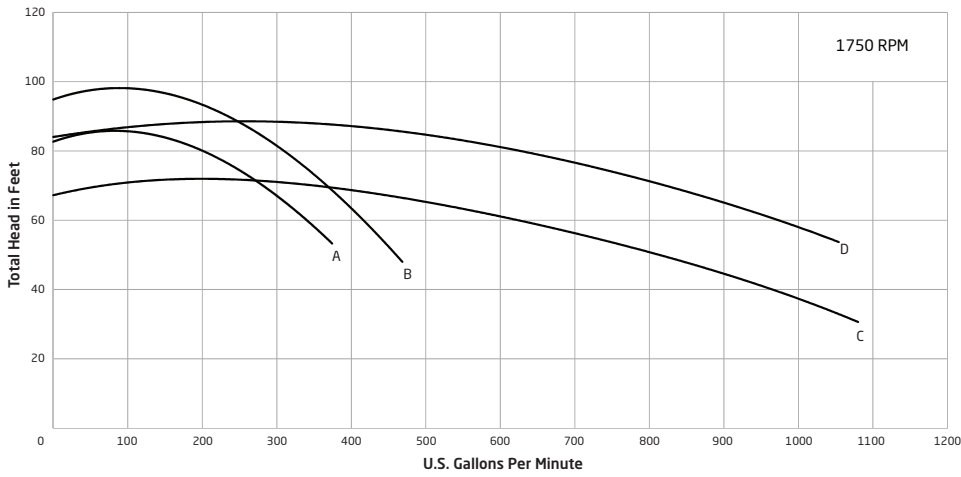

- A. 65/250 (Ø 225mm) - 7.5 HP S.F. 1.25
- B. 65/250 (Ø 240mm) - 10 HP S.F. 1.25
- C. 100/250 (Ø 220mm) - 15 HP S.F. 1.25
- D. 100/250 (Ø 240mm) - 20 HP S.F. 1.25

BADU Block & Normblock Multi 125/250 Series (20 HP, 25 HP, 30 HP)

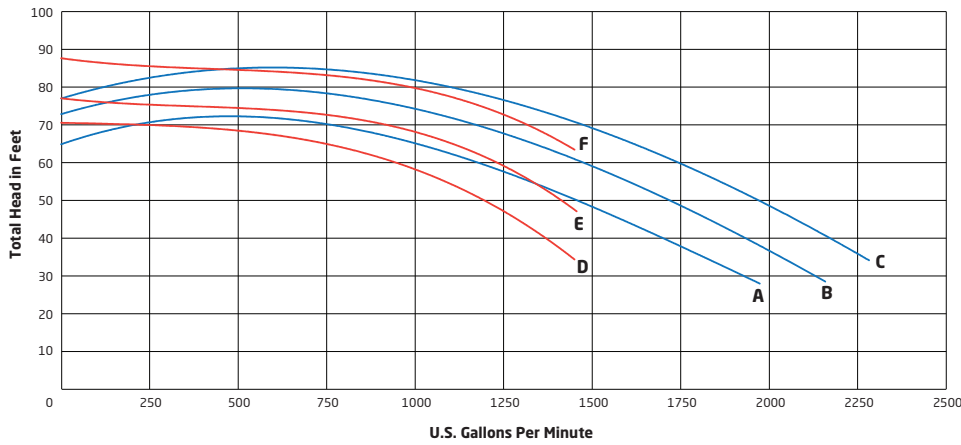

Normblock Multi 125/250
(Horizontal Pump)

- A. 125/250 (Ø 235mm) - 20 HP S.F. 1.25
- B. 125/250 (Ø 245mm) - 25 HP S.F. 1.15
- C. 125/250 (Ø 255mm) - 30 HP S.F. 1.15

BADU Block Multi 125/250
(Vertical Pump w/ ceramic coated cast iron strainer housing - 10" suction port)

- A. 125/250 (Ø 235mm) - 20 HP S.F. 1.25
- B. 125/250 (Ø 245mm) - 25 HP S.F. 1.15
- C. 125/250 (Ø 255mm) - 30 HP S.F. 1.15

BADU Block Multi 125/250
(Vertical Pump w/ plastic strainer housing - 8" suction port)

- D. 125/250 (Ø 235mm) - 20 HP S.F. 1.25
- E. 125/250 (Ø 245mm) - 25 HP S.F. 1.15
- F. 125/250 (Ø 255mm) - 30 HP S.F. 1.15

Discharge Connection Positions

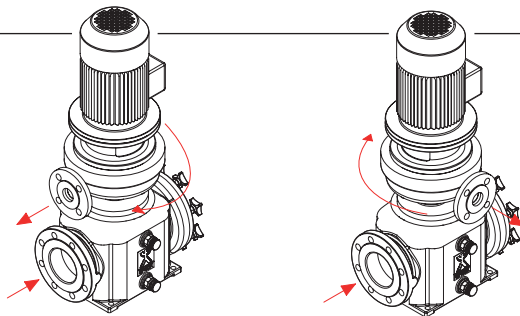

Discharge connection can be rotated in 45° increments.

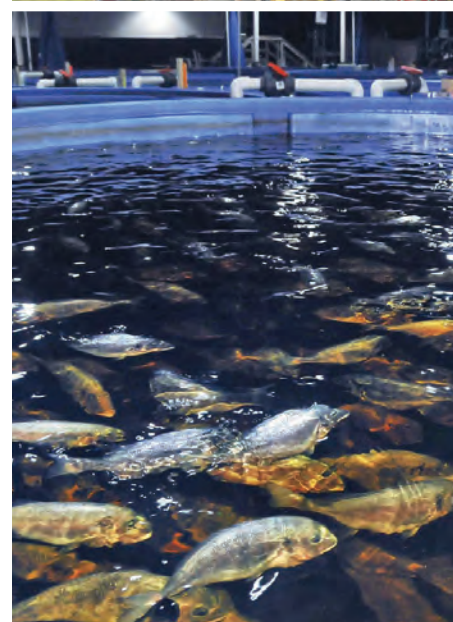

WE BRING WATER TO LIFE™

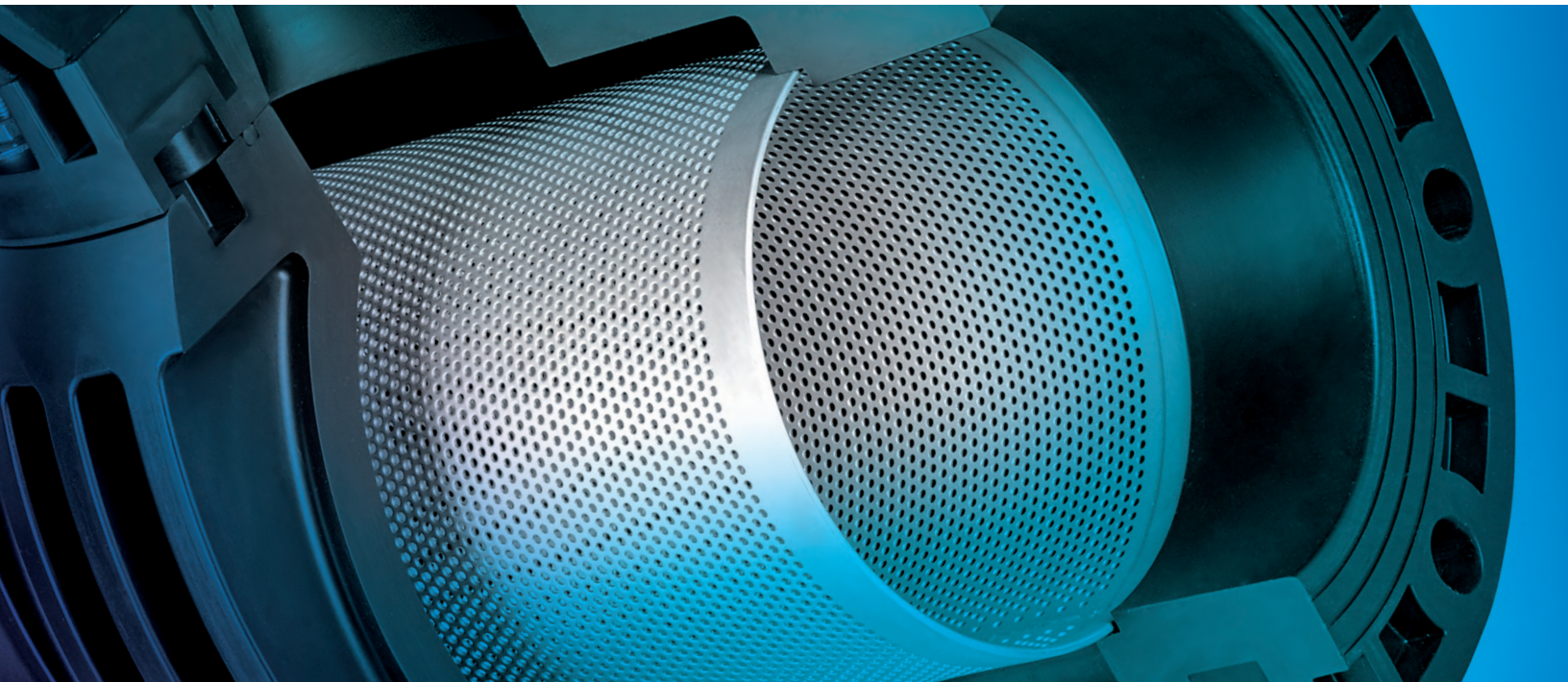

SPECK X
pumps

8125 Bayberry Road
Jacksonville, FL 32256 USA

info.usa@speck-pumps.com
www.speck-pumps.com

Toll Free 800.223.8538
Phone 904.739.2626
Fax 904.737.5261

