

# AIPER®

## CORDLESS ROBOTIC POOL CLEANER ROBOT DE PISCINE SANS FIL

Aiper Scuba P1 Ultra

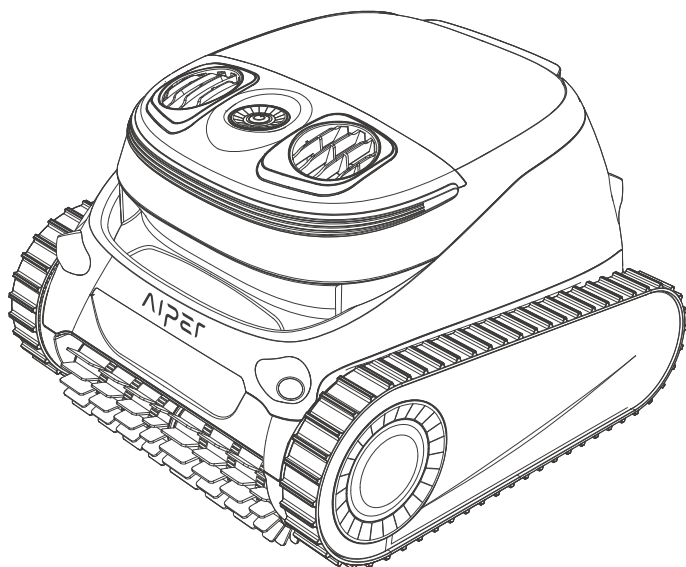

User Manual / Manuel d'utilisation



## CONTENTS / SOMMAIRE / CONTENIDOS

---

English / Anglais / Inglés	-----	1-21
French / Français / Francés	-----	22-42
Spanish / Espagnol / Español	-----	43-63

---

## FCC Statement

This device complies with Part 15 of the FCC Rules. Operation is subject to the following two conditions: (1) This device may not cause harmful interference, and (2) this device must accept any interference received, including interference that may cause undesired operation.

**Warning:** Changes or modifications not expressly approved by the party responsible for compliance could void the user's authority to operate the equipment.

**Note:** This equipment has been tested and found to comply with the limits for a Class B digital device, pursuant to Part 15 of the FCC Rules. These limits are designed to provide reasonable protection against harmful interference in a residential installation.

This equipment generates, uses, and can radiate radio frequency energy and, if not installed and used in accordance with the instructions, may cause harmful interference to radio communications. However, there is no guarantee that interference will not occur in a particular installation. If this equipment does cause harmful interference to radio or television reception, which can be determined by turning the equipment off and on, the user is encouraged to try to correct the interference by one or more of the following measures:

- (1) Reorient or relocate the receiving antenna.
- (2) Increase the separation between the equipment and receiver.
- (3) Connect the equipment into an outlet on a circuit different from that to which the receiver is connected.
- (4) Consult the dealer or an experienced radio / TV technician for help.

## Radiation Exposure Statement:

1. This equipment complies with FCC radiation exposure limits set forth for an uncontrolled environment.
2. This equipment should be installed and operated with minimum distance 20cm between the radiator & your body.

Importer: Aiper Intelligent, LLC.

Address: 8735 Dunwoody Place, STE 6, Atlanta, Georgia 30350, USA. (Not for Returns)

US Toll-Free: +18668500666 AU Toll-Free: +611800497023

## IC Statement

This device complies with Industry Canada license - ICES-003. Operation is subject to the following two conditions: (1) This device may not cause interference, and (2) This device must accept any interference, including interference that may cause undesired operation of the device.

CAN ICES-003 (B)/NMB-003(B)

## Radiation Exposure Statement:

1. This equipment complies with IC radiation exposure limits set forth for an uncontrolled environment.
2. This equipment should be installed and operated with minimum distance 20cm between the radiator & your body.

## Button Cell Battery

# WARNING

- **INGESTION HAZARD:** This product contains a button cell or coin battery.
- **DEATH** or serious injury can occur if ingested.
- A swallowed button cell or coin battery can cause **Internal Chemical Burns** in as little as **2 hours**.
- **KEEP** new and used batteries **OUT OF REACH of CHILDREN**
- **Seek immediate medical attention** if a battery is suspected to be swallowed or inserted inside any part of the body.



1. Remove and immediately recycle or dispose of used batteries according to local regulations and keep away from children. Do NOT dispose of batteries in household trash or incinerate.
2. Even used batteries may cause severe injury or death. Call a local poison control center for treatment information.
3. Product contains non-replaceable button cell batteries.
4. The compatible button cell battery types for this device are: CR1225, with a nominal voltage of: 3.0V.
5. Non-rechargeable batteries are not to be recharged.
6. Do not force discharge, recharge, disassemble, heat above 265°F (130°C) or incinerate. Doing so may result in injury due to venting, leakage or explosion resulting in chemical burns.

Thank you for choosing Aiper.

You've now joined a family of millions who have already put their trust in Aiper to take care of their pools and are enjoying the convenience of a pristinely clean pool.

This user manual will help you maintain your Aiper pool cleaner and ensure it performs at its maximum efficiency for years to come. Please take a few minutes to read through this manual.

If you have any questions, please visit our website at [www.aiper.com](http://www.aiper.com) and contact our customer service team for assistance or more information.

### Aiper Customer Service:

US Toll-Free: +18668500666

AU Toll-Free: +611800497023

Email: [service@aiper.com](mailto:service@aiper.com)

Facebook: [@AiperOfficial](https://www.facebook.com/AiperOfficial)



Scan for  
Video Guide



Scan the QR  
Code to Access  
Customer Support

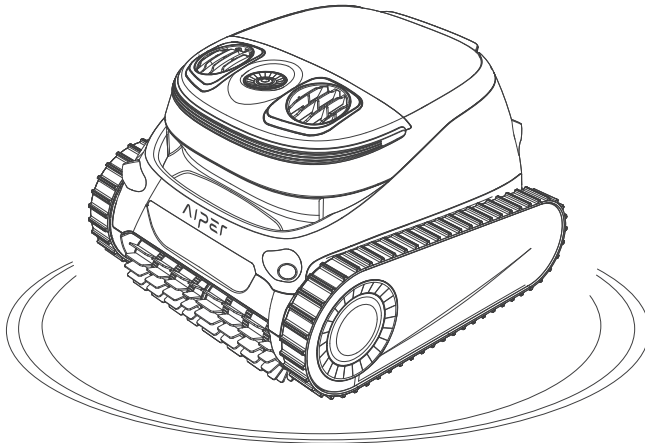



## IMPORTANT SAFETY PRECAUTIONS

Read this manual carefully and use your device in accordance with the instructions. Aiper is not liable for any damages or injuries caused by improper use.

For your safety and optimal performance of this device, please read and follow the following suggestions.

### 1. READ AND FOLLOW ALL INSTRUCTIONS.

2. Do not operate the device when people or animals are in the pool.
3. Ensure the device is turned off when conducting maintenance, cleaning, or when not in use.
4. Do not allow children to ride the device or play operate it without adult supervision.
5. Only use the original, authorized power adapter.
6. The adapter cord should only be replaced by a qualified electrician.
7. It is strongly recommended to connect the charger to a surge protector when charging.
8. Ensure the charging port is completely dry before charging your device.
9. While charging, the device should be kept in a cool, well-ventilated place. Customers should not over the device while charging as this may lead to overheating or hardware malfunctions.
10. Do not operate the device out of the water, as this may lead to hardware malfunctions or overheating.
11. Only certified professionals should disassemble the driving kit of the device.
12. Do not operate the device while running your pool filter.
13. Avoid puncturing the oil sealing of the motor, as this contains grease. If punctured, this may cause a small grease leakage into your pool.
14. Do not store or use the device near anything that generates extreme heat.
15. Do not pierce or bludgeon the device's shell, as this will cause irreparable damage. Additionally, the device should not be thrown.

16. WARNING – To reduce the risk of injury, do not permit children to use this product unless they are closely supervised at all times.
17. Ensure that children do not attempt to access cleaner while it is operating.
18. CAUTION:
  - a. FOR USE WITH SWIMMING POOLS ONLY.
  - b. DO NOT RUN PUMP DRY.
  - c. TO REDUCE THE RISK OR INJURY, USER MUST READ MANUAL.
  - d. FOR USE ONLY WITH AC/DC ADAPTOR, MODEL:  
GM95-294300-1FGN.

**SAVE THESE INSTRUCTIONS**

Please read this user manual carefully before operating the device.

## 1. Structure

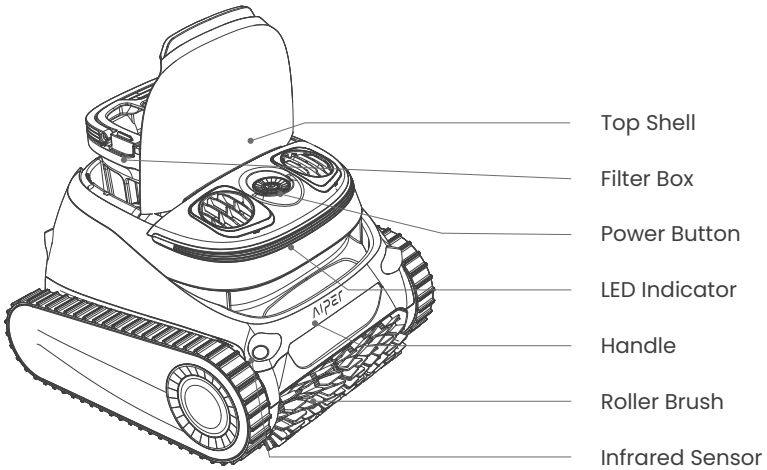

Retrieval Hook

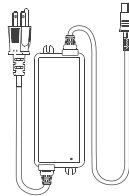

Charger

## 2. Specifications & Working Conditions

1. Pool Size: 2150 sq. ft./ 200m <sup>2</sup>
2. Charger Input: 100-240V~, 50/60Hz, 2.5A
3. Charger Output: 29.4V=3A
4. Charging Time: 5 Hours
5. Battery Life: Up to 180 Minutes
6. IP Grade: IPX8 Waterproof
7. Water Depth: 10ft(3m)
8. Suction Power: 7800GPH (29520LPH)
9. Battery Pack: 10400mAh (262.08Wh)
10. Battery Pack Voltage: 25.2V=
11. Bluetooth frequency range: 2402-2480 MHz, Maximum E.I.R.P: 6.92 dBm
12. 2.4G Wi-Fi frequency range: 2412-2472 MHz, Maximum E.I.R.P: 18.81 dBm

### CAUTION:

Do not use the device in a pool environment beyond the conditions described below, doing so may cause damage to the device that will not be covered by your warranty.

- Temperature: 50-95°F (10-35°C)
- pH Value: 7.0-7.4
- Chlorine: Maximum 4 ppm
- NaCl: Maximum 5000 ppm

## 3. Charging

**CAUTION:** Do not charge the device in direct sunlight.

- Fully charge the device before using it to clean your pool.
- Before charging, remove the charging port cover to check if there is any residual water in the charging port. If so, wipe dry the charging port before charging.
- Insert the charging cable into the charging port of the device and then into an available electrical outlet. The LED indicator on the device will start to pulse, indicating that the device is being charged. After the device is fully charged, the LED indicator will remain on for 15 minutes before turning off.

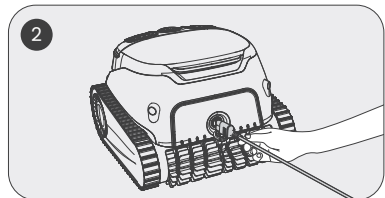
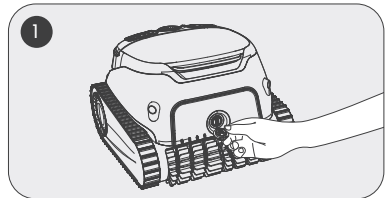

## 4. Using Your Aiper Pool Cleaner

a. This device is suitable for cleaning the floors, walls, and waterlines of your pool within an area of up to 2150 sq. ft. / 200m<sup>2</sup>.

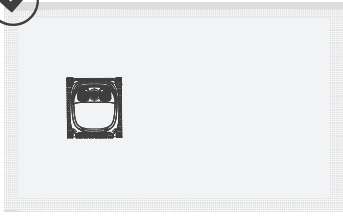

← 2150 sq. ft./200m<sup>2</sup> →

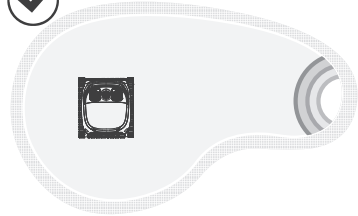

## 5. Operating Your Device

a. Press and hold the Power Button for 2s to turn on/off the device.

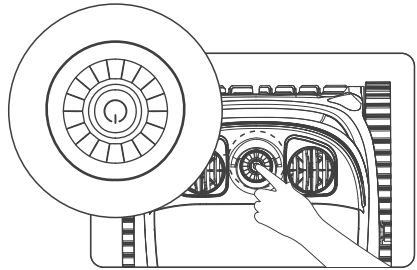

b. Auto mode is the default mode for this device once turned on. Press the button to switch between Auto, Floor, Waterline, and Eco Mode.

1) Auto Mode: The device will clean your pool's floors and walls. When the battery level is low (LED indicator turns solid red), the device will automatically stop cleaning and dock.

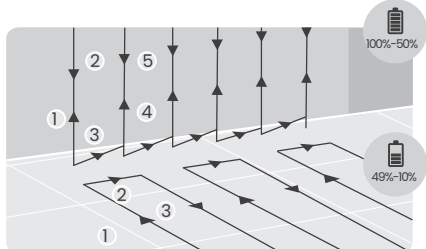
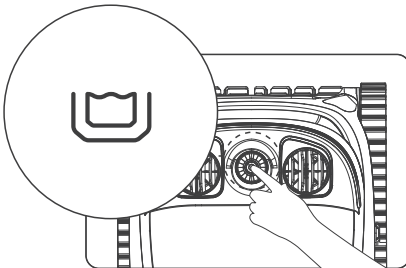

**Auto Mode: cleaning the pool**

- 2) Floor Mode: The device will clean the pool floor in an S-shaped route, without climbing or cleaning walls. When the battery level is low, the device will automatically stop cleaning and dock.

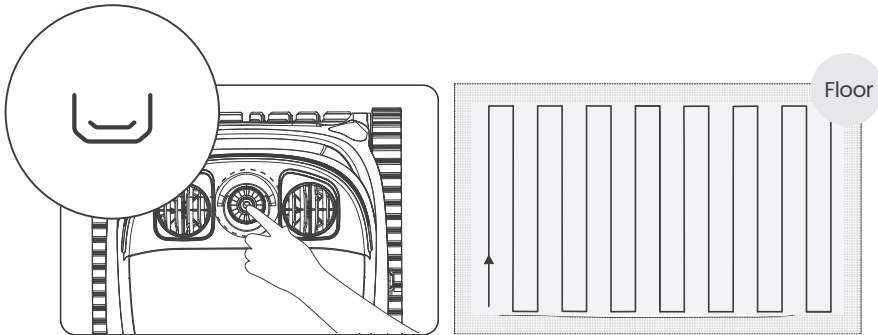

**Floor Mode**

- 3) Waterline Mode: The machine will move horizontally and clean along the waterline. When running into corners or obstacles on the pool walls, it will descend from the waterline, switch walls or bypass obstacles, and resume cleaning.

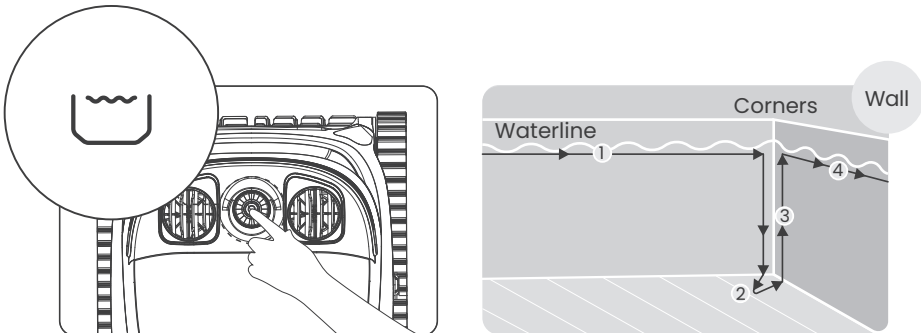

**Waterline Mode**

- 4) Eco Mode: On a fully charged battery, the device will clean the floor of your pool for 45 min once every 48 hours for one week.

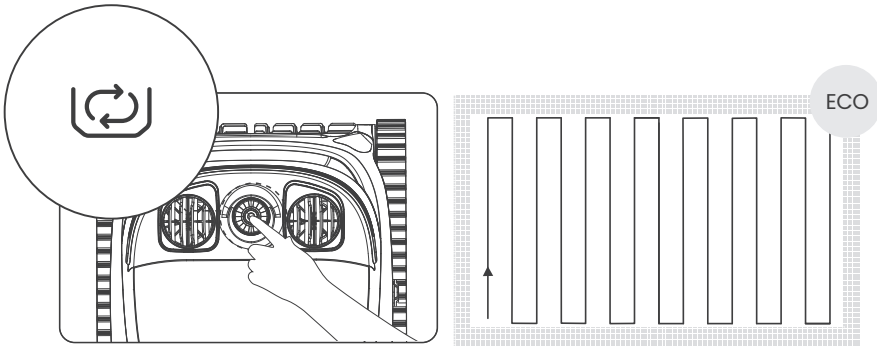

Eco Mode

- 5) Wall Mode: Only configurable via the Aiper APP, the device will clean the pool walls in an N-shaped route, and not clean the floors. When the battery level is low, the device will automatically stop cleaning and dock.

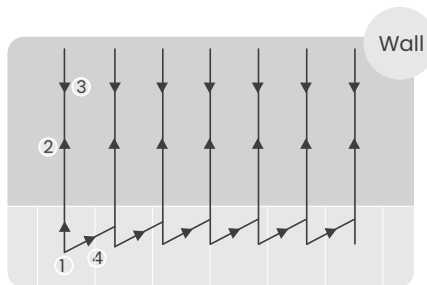

Wall Mode

- c. After selecting a cleaning mode, the device will rotate its water pump every 10 seconds, 3 times in total, to check if it has been put into the pool. If the device fails to detect water during this process, it will automatically shut down. The device will start cleaning within 10 seconds of reaching the pool floor.
- d. When the battery level is low, the device will automatically stop cleaning and dock by the nearest wall.

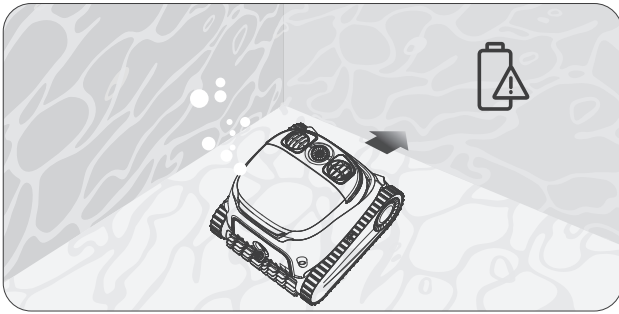

- e. Lift the device from the pool floor with a hook to prevent getting wet. Users can connect the hook to any standard pool cleaning rod (not included) to extend the reach of the hook.

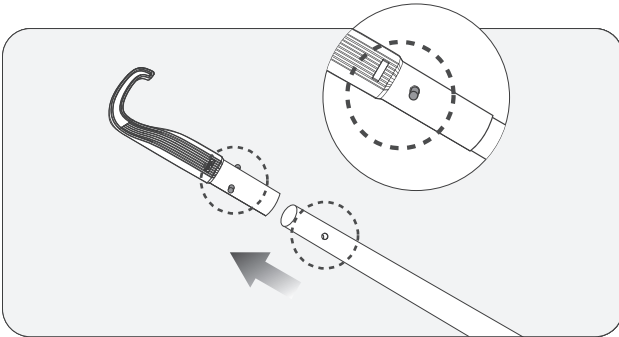

f. Allow the device to drain any stored water before storing it.

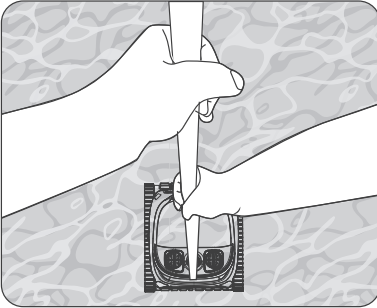

g. Hold the handle and allow the device to drain any stored water.

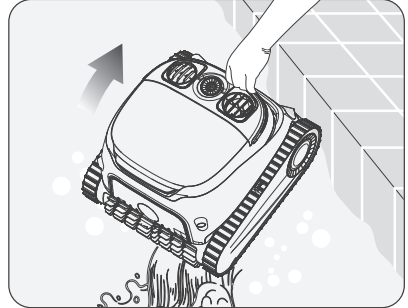

## 6. Disassembly and Cleaning

a. Set aside the device in a safe, secure location and open the Top Shell.

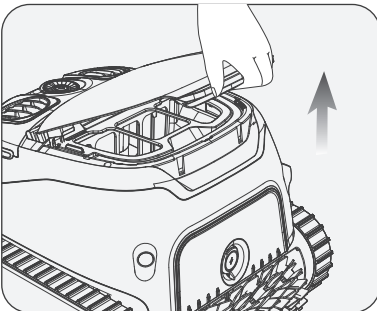

b. Remove the Filter Box by lifting its handle.

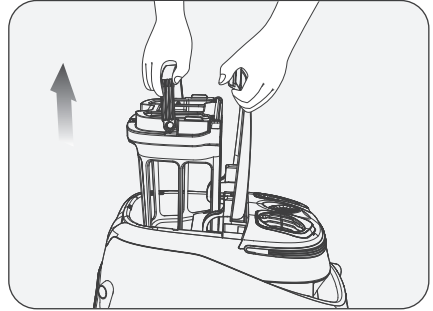

c. Press the latch of the top shells latch of the filter box and at the same time pull up on the top cover handle to open the filter box.

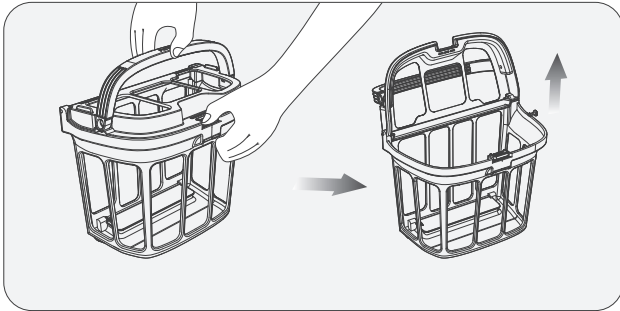

- d. Empty the Filter Box, rinse, and replace it back into the device once cleaned.
- e. Please remove and clean the ultra-fine filter immediately after cleaning is complete to avoid accumulation of dirt and debris which may damage the filter. It is recommended to use a high-pressure water gun to flush any accumulated debris immediately.

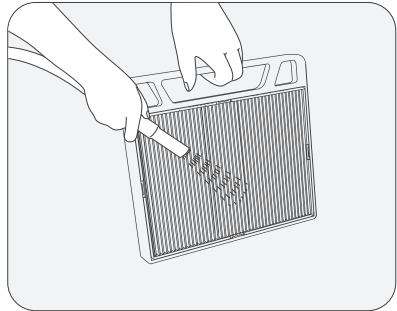
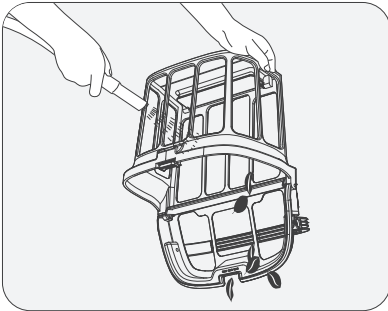

## 7. Aiper App User Guide

### 7.1 How to download and install the Aiper App

- a. Search for "Aiper" in your devices App store, download, and install the APP on your mobile.
- b. Start the app and register. Then log in to the app using the data (email address and password) that you provided during registration.



### 7.2 How to Add and Use Devices

- a. Before adding a device, please confirm the following:
  - The area where the device is used has 2.4G Wi-Fi coverage. 5G Wi-Fi is not supported.
  - Your phone supports Wi-Fi and Bluetooth, and Bluetooth is activated.
  - The phone is within 20ft/6m of your new device.
- b. Tap the "+" in the top right corner of the App's homepage, select "Add Device", and follow the instructions to add the device.
- c. After adding the device, you can configure and view your Aiper device and features in the Aiper APP.

**Note:** Some features of your device will only be accessible while your device is out of the water. Once submerged, you will lose connection and cannot control your device via the APP.

## 8. Maintenance

### 8.1 Replacing the tracks.

a. Remove the side cover plate from the device.

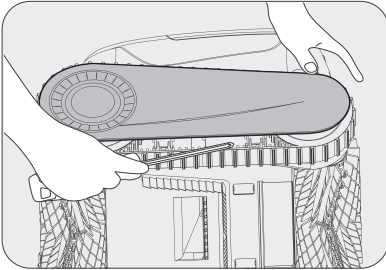

b. Remove the screws and the guide sleeves from the wheels.

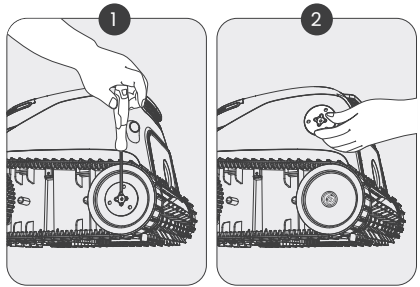

c. Pull the wheels and the track together to remove them.

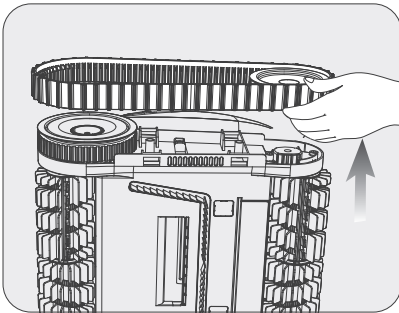

d. Align the gears on the new tracks with the gears on both wheels, then install the rear wheels and tracks together back onto the shaft sleeves.

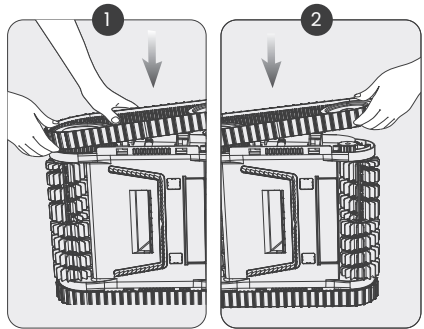

e. Re-install the guide sleeves by aligning their D-shaped openings with that of the shaft sleeves.

f. Tighten the screws and re-install the side cover plate.

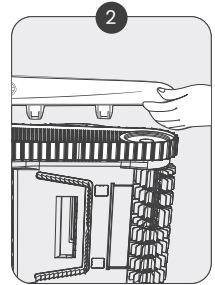
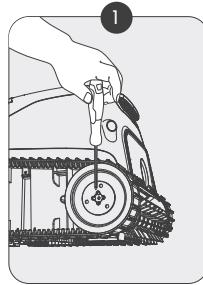
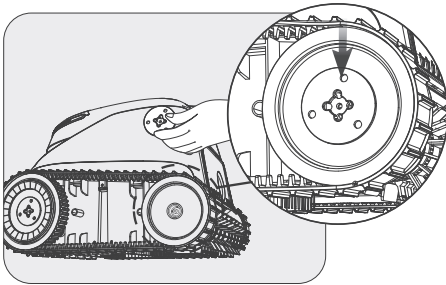

## 8.2 Replacing the roller brush belt.

a. Find the side that looks different from the other roller brush belts, and pull down the silicone buckles that are stuck in the fixed slot.

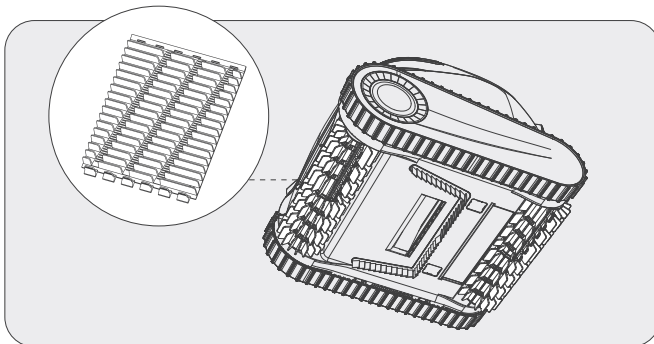

b. After all the silicone buckles are pulled out, replace the roller brush belt with a new one. Align the silicone buckles with the fixed slot and pull them outward. They can be fixed after passing through the slot.

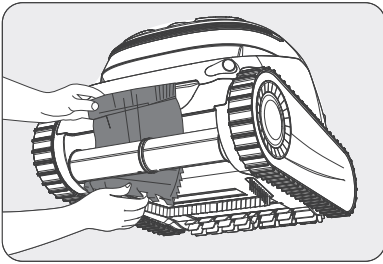

### 8.3 Cleaning the drain.

a. Lift the top shell.

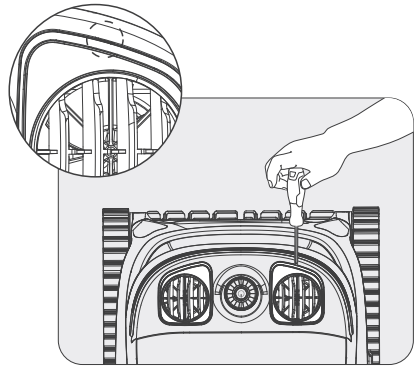

b. Remove the screws and drain cover.

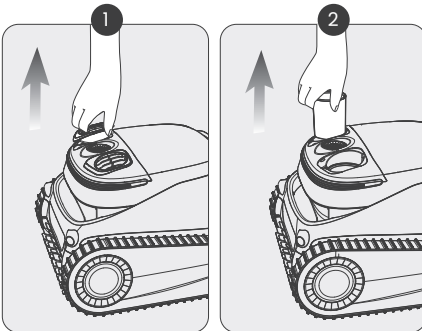

c. Remove any objects entangled in the drains fan blades, and then re-install the drain cover and screws.

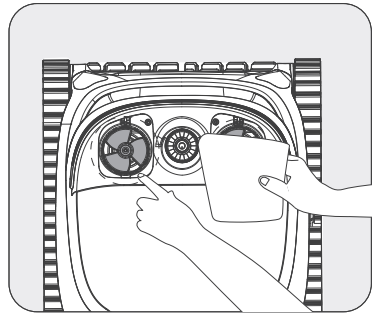

## 9. Storage

### Winter Tips: How to store and secure your Aiper devices

How should I store my Aiper device during the off-season?

In your pool's off-season, such as winter months or long vacations when your Aiper device won't be used, there are a few steps to take to protect your device and keep it in the best condition possible.

1. Power off your device and disconnect it from the charger.
2. Clean the device of any residual dirt, including the top & bottom shell, wheels, roller brushes, and charging port.
3. Using a paper towel or soft cloth, wipe dry your device.
4. Box and store your device in a cool, well-ventilated area.
5. Charge your device every TWO months to 40%-60% battery capacity to maintain the battery health of your device.

When you're ready to use your Aiper device in your pool, fully charge the device before using it in your pool, and never charge your device in direct sunlight.

## 10. LED Indicator Lights

Light Status	Device Status	Description	
Pulsing Light	Charging	The LED indicator color changes with the battery level. During charging, the light will pulse slowly. Once fully charged, the indicator will turn steady blue for 15 minutes before turning off.	Blue (steady): 100% (off after 15 min)
			Blue: > 51%
			Yellow: 50-16%
			Red: < 15%

Light Status	Device Status	Description	
Solid Light	Operating	The LED indicator color changes with the battery level.	Blue: > 51%
			Yellow: 50-16%
			Red: < 15%
Red Light Flashes Rapidly	Device Malfunction	Filter screen blockage, motor stalling, electrical leakage, etc.	

## 11. Frequently Asked Questions

**Q: Which pool types & structures is this device suitable for? Are there pools not suitable for this device?**

A: The device performs as intended in pools made of concrete, fiberglass, vinyl, mosaic tiles and other materials; it cannot be used for infinity pools.

**Q: Can the device clean steps?**

A: The device can climb steps, but it cannot clean them.

**Q: Why does the device automatically shut down after being turned on?**

A: After the device is turned on, it will activate the water pump every 10 seconds to check for water. This process will occur 6 times. If the device does not detect water during this process, it will automatically shut down.

**Q: Why does the device stay on my pool drain for a long time?**

A: The suction of your pool drain may pull your device onto it, preventing the device from continuing its cleaning operations. Do not, under any circumstances, open the drain outlet while your device is cleaning the pool. If the device has become stuck, it will adjust its propulsion and work free within 3 minutes.

**Q: How do I use Periodic Cleaning?**

A:

- 1) After turning on the device, short press the button to select Periodic Cleaning, also known as Eco Mode, and put the device into the water. The device will clean the bottom of the pool every 24-48 hours for 45 minutes each cleaning, and a total of three cleaning sessions.
- 2) The device may be left in the pool during the entire process and does not need to be retrieved until the three cleaning cycles have completed.
- 3) If the device is removed from the pool during the device's sleep period and an operations button is pressed, the device will automatically exit Periodic Cleaning/Eco Mode.

**Q: Why did the device not complete 3 full floor cleanings while in Eco Mode?**

A: It is recommended to fully charge your device before using Eco Mode. If the battery is insufficient, the device may not be able to complete a full week's worth of cleaning.

**Q: Why does the device not achieve the expected cleaning results?**

A:

- 1) The debris bin or filter may be clogged. It is recommended to wash these after each use to prevent debris from hardening in your device, thereby affecting performance.
- 2) If performance is related to a clogged impeller, please disassemble, and clean the impeller as described in section 8.3 of the instruction manual.
- 3) The roller brush or filter is aging, and needs replaced.

**Q: Why does the device leak garbage after being removed from the pool?**

A: Please check if that the water inlet cover at the bottom of the debris bin is blocked by an object, as this may result in debris escaping the device. Please clean the device after each use to prevent blockage of these systems.

**Q: Why doesn't the device climb the wall?**

A:

- 1) The contact surface between the caterpillar tread and the wall is insufficient, resulting in the device being unable to climb.
- 2) The debris bin is full or the filter is clogged, causing the device to fail to climb the wall.

**Q: Why does the front part of the device lift up and how can I solve it?**

A: This action may be caused by the debris bin being full or the filter being clogged. Please use a high-pressure water gun to flush the debris bin.

## 12. Packing List

NO.	Name	Model	QTY(pc)
1	Cleaner	Aiper Scuba PI Ultra	1
2	DC Charger	/	1
3	Retrieval Hook	/	1
4	User Manual	/	1
5	Extra PVC Brushes	/	4
6	Extra 3µm Ultra-fine Filter	/	2

## 13. Warranty

This product has passed quality control and safety test conducted by our technicians.

1. This product comes with a 24-month warranty that covers your item's battery and motor from the date of purchase.
2. This warranty is voided if the product has been altered, misused, or has been repaired by unauthorized persons.
3. This warranty extends only to manufacturing defects and does not cover damage resulting from the mishandling of the product by the owner.
4. The order number or record of purchase must be presented at the request of any repair claim during the warranty period.



This symbol indicates that this product shall not be treated as household waste. Instead it shall be handed over to the applicable collection point for the recycling of electrical and electronic equipment.