

**MODELS RC554XP AND 554000**

**ORP/pH Digital Controller**

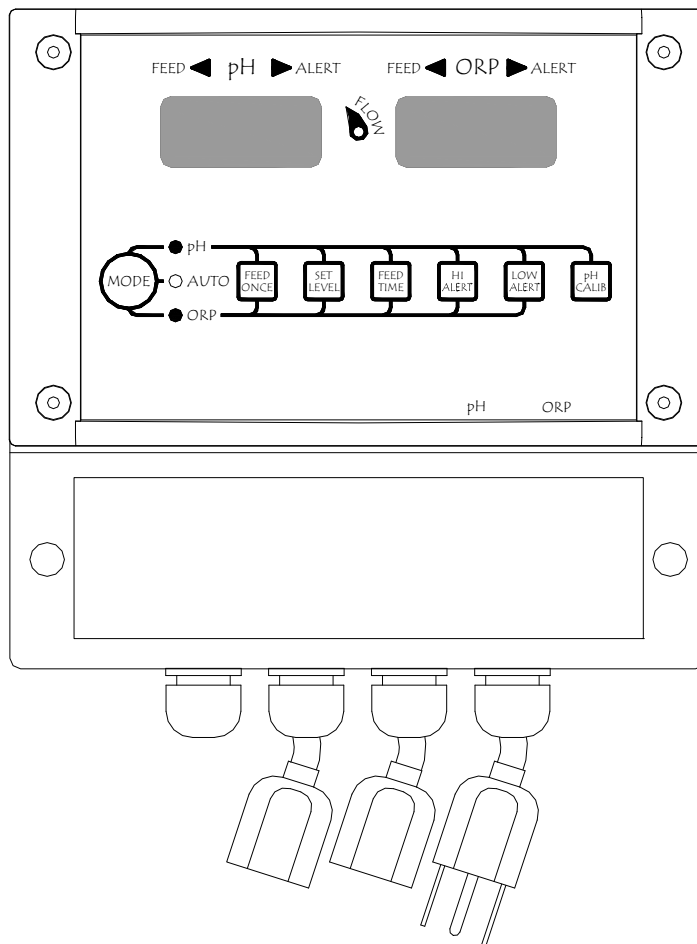

**IMPORTANT SAFETY INSTRUCTIONS**  
**READ AND FOLLOW ALL INSTRUCTIONS**  
**SAVE THESE INSTRUCTIONS**

**1. SAFETY: When installing and using this electrical equipment, basic safety precautions should always be followed, including:**

**1.1 WARNING!** To reduce the risk of injury, do not permit children to use this product unless they are closely supervised at all times

**1.2 WARNING!** Risk of electric shock.

Connect only to a grounding type receptacle protected by a ground-fault circuit interrupter (GFCI). Contact qualified electrician if you cannot verify that the receptacle is protected by a GFCI and that your installation meets local electrical codes, including grounding of water system components.

**1.3 WARNING!** Risk of electric shock.

Do not bury electric cords. Locate cord to minimize abuse from lawn mowers, hedge trimmers, and other equipment. Replace damaged cords immediately. Do not use extension cords.

**1.4 WARNING!** Risk of electric shock.

Install at least 10 feet (3.0m) from inside wall of water enclosure using non-metallic plumbing. Do not install this controller in a location accessible to the public.

**1.5 WARNING!** Risk of Chemical Overdose/Exposure.

Removing power from circulating pump must also remove power from the controller. Provide a properly located outlet controlled by the circulating pump circuit.

**1.6 WARNING!** Risk of electric shock/pinching/chemical exposure.

Remove power sources or lockout circuit prior to performing maintenance on controller.

**1.7 WARNING!** Risk of Chemical Overdose/Exposure.

Use a device such as a flow switch to shut off power from the controller in the event of circulating pump failure. It is unsafe to automatically dispense chemicals into a circulating system that is not running.

**1.8 WARNING!** Risk of Chemical Exposure.

Pool water must be balanced and stabilized before operating this controller.

**1.9 WARNING!** Risk of Chemical Overdose/Exposure.

Minimize amount of chemical on site that is available to dispense.

Size the feeder and container to pool/spa capacity.

Dilute chemical for small bodies of water.

**1.10 WARNING!** Risk of Chemical Exposure.

Do not shut down circulation and control system immediately after using pool, spa or hot tub. Systems must operate until water chemistry is stable. Systems must be restarted before water chemistry is out of NSPI recommended ranges or water chemistry must be manually corrected.

**1.11 WARNING!** Controller uses microprocessor.

Wireless communication equipment or other electrical devices operated in close proximity may cause inadvertent actuation of chemical feed pumps.

# Table of Contents

<b>Section title</b>	<b>Page</b>
1. Safety Instructions	2
2. Quick Start Reference	4
3. Description and Specifications	
3.1 General Description	5
3.2 Specifications	7
3.3 Description of controls	8
4. Installation	
4.1 Locating the controller	12
4.2 Mechanical installation	12
4.3 Power panel access	13
4.3.1 Dip switches	13
4.3.2 Fuses	13
4.3.3 Flow switch	13
4.3.4 Globe Flowcell	14
5. Operation	
5.1 Startup	15
5.2 pH settings	15
5.3 pH Calibration	15
5.4 ORP settings	15
5.5 Operating mode	16
6. Troubleshooting	17
7. Warranty	19
8. Appendix	
8.1 Dip switch settings	20
8.2 Factory default settings	21
8.3 Water chemistry ranges-NSPI	21
8.4 Typical system installations	22

## 2. Quick Start Reference

Use this section for reference. Please read all safety instructions and appropriate manual sections for installation and operation instructions.

- Do NOT add chemicals to feeders until all startup operations are completed.
- Manually adjust and balance pool/spa to acceptable levels and verify using DPD test kit prior to startup. Automation should be used to maintain chemical levels, not to balance a pool/spa that is out of acceptable chemical ranges.

### On/Off:

- Press the MODE button to turn the unit on. Note: 'FLOW' light must illuminate.
- To turn the unit off press and release MODE button to change to ORP or pH mode. Then press and hold the MODE button. "OFF" will be displayed in the windows.

### To Operate:

- Press and release the MODE button until the "AUTO" LED is lit.
- Unit will now operate in the factory preset settings:
  - Set levels: ORP = 650 mV, pH = 7.4
  - Feed times: 0.6 second feed with a 5-minute delay
  - Alert Limits: ORP: 900 high, 100 low, pH: 8.0 high, 7.0 low

### To Change Settings:

Press and release the MODE button until the desired ORP or pH LED is lit. Once the settings are changed, they will remain at those settings until they are changed again.

- Set level: press the SET LEVEL button until the desired set point is reached. Release the button.
- Feed time: press the FEED TIME button until the desired feed time is reached. Release the button.

The numbers represent the seconds of feed time (all with 5-minute delays).

Range is 0.6 to 900 sec. (15 min.). Continuous feed is 'con'.

- Hi alert: press the HI ALERT button until the desired level is reached. Release the button
- Low alert: press the LOW ALERT button until the desired level is reached. Release the button.
- Consecutive Feed Alert Limit: See Appendix for adjusting limit.

### Manual Feed:

- Press and release the MODE button to light the LED associated with the desired feeder to be manually fed: ORP or pH.
- Press the FEED ONCE button. The desired feeder will go through one "set feed" time cycle. There is no manual feed option when the unit is in Continuous feed.

**Other:** See the appropriate manual sections for:

- Calibrating the pH sensor – See section 5.3
- Changing dip switches (pH/ORP interlock, Consecutive Feed Alert Limit, acid/base chemical feed and keypad lockout). – See Appendix section 8.1

### 3. Description and Specifications

#### 3.1 General Description

The controller is a microprocessor-based chemical automation system which continuously monitors and maintains the pH balance and sanitizer level in a swimming pool or spa.

The pH and sanitizer level (ORP) are displayed using sun-bright seven-segment light emitting diodes. The pH and ORP levels are continuously monitored and displayed on the controller's front panel. The ORP/pH controller has been designed to be user friendly. One MODE button and six SET buttons allow the operator to easily set parameters.

The pH display range is 6.0 to 8.4 with a .1 unit resolution. The pH set point is adjustable from 7.0 to 8.0 in .1 pH steps with a factory default set point of 7.4 pH. During a pH feed cycle, the pH feed lamp will flash when pH chemicals are being fed and illuminate continuously during the feed delay portion of the feed cycle. The pH Alert lamp will illuminate when the pH reading is higher or lower than the high and low pH Alert set points and prevent the feeding of pH chemicals. The Digital Display numbers will flash and the pump/feeder will not activate if the Set Level is not reached within the preset Consecutive Feed Alert Limit. The default value is 20 cycles for timed feed mode or 20 minutes for continuous feed mode. See appendix for setting Consecutive Feed Alert Limit.

The sanitizer (ORP) display range is 0 to 995 mV with a 5 mV display resolution. The ORP set point is adjustable from 400 to 900 mV with default set point of 650 mV.

During an ORP feed cycle, the ORP feed lamp will flash when sanitizer chemicals are being fed and illuminate continuously during the feed delay portion of the feed cycle. The ORP Alert lamp will illuminate when the ORP reading is higher or lower than the high and low ORP Alert set points and prevent the feeding of sanitizer chemicals. The Digital Display numbers will flash and the pump/feeder will not activate if the Set Level is not reached within the preset Consecutive Feed Alert Limit. The default value is 20 cycles for timed feed mode or 20 minutes for continuous feed mode. See appendix for setting Consecutive Feed Alert Limit.

A manual feed cycle for pH or ORP can be started by pressing the MODE button (placing the controller in stand-by mode for either pH or ORP) and then pressing the FEED ONCE button.

The feed cycle is a timed-based 'feed then delay' system. The controller has a series of fixed feed times (0.6 to 900 sec.) with associated delays as well as a Continuous feed mode. A feed cycle consists of a feed time plus a delay time. Example: a 30 second feed time followed by a five-minute delay would have a 5½ minute feed cycle. The chemical feeder dispenses chemical only during the feed time portion of the cycle and then waits for a delay period to allow for chemical to dispense throughout the swimming pool or spa.

The controller incorporates an internal non-volatile memory in which all factory default settings as well as field-modified settings are stored. The internal memory is not affected by power interruption and requires no backup battery.

Acid/base, pH/ORP interlock, Consecutive Feed Alert Limit and keypad lockout control switches are located behind the Power Panel Access Cover. See section 4.3.

The pH and ORP outputs are capable of handling 5 amps each at 120 Volt AC. The relay outputs are fused and transient protected. An internal terminal strip is provided for field wiring of the controller. The internal step-down transformer has a class-two energy limiting rating to provide for electrical safety.

*Note: When automating any body of water, it is essential to size the feeders to reach desired levels in a relatively short period of time. Generally, automating an existing body of water with existing feeders will require the output of the feeders be increased accordingly. If feeders are unable to keep up with demand in a short period of time, automation becomes ineffective.*

## 3.2 Specifications

ORP & pH Ranges	ORP	pH
Display:	0 to 995 mV	6.0 to 8.4
Set Level:	400 mV to 900 mV (5 mV increments)	7.0 to 8.0
Factory default:	650 mV	7.4

### Input Power:

120 Volts AC, 50/60 HZ, 3 wire grounded power cord  
Combined load not to exceed 10 amps  
GFCI source required

### Output Power:

120 Volts AC, 50/60 HZ, 5 amps (fused) for both ORP and pH  
Two 3-wire grounded power receptacles  
Terminal strip for hardwire applications included

### Displays:

ORP and pH - red digital  
Power and flow indicator - LED  
Alert indicator & Feed indicator - LED (ORP & pH)  
Mode indicator - LED (pH, ORP, Auto)

Note: feed lamps flash during the feed time and are on continuously during the delay time of the feed cycle.

Operating Temperature: 40 to 120° F

### Selectable Features

+ ORP and pH settings		+ Manual feed
+ ORP and pH feed/delay times	+ Keypad lockout	+ pH calibration
+ High and low ORP and pH alerts	+ Reset	+ ORP and pH Interlock
+ Acid/base feed	+ Adjustable Consecutive Feed Alert Limit	

### Features and Options

+ Flow switch input	+ Individually fused outputs	+ 120 VAC transformer
---------------------	------------------------------	-----------------------

### 3.3 Description of Controls

#### 1- WATER FLOW LAMP

Illuminates brightly when water flow is indicated. Also indicates that power is on.

#### 2- pH/ORP ALERT LAMPS

Illuminates red when the Hi or Low Alert levels are reached.

#### 3- CHEMICAL FEED LAMPS

pH FEED lamp flashes while feeding chemical and illuminates continuously during feed delay.

ORP FEED lamp flashes while feeding chemical and illuminates continuously during feed delay.

#### 4- pH/ORP DIGITAL DISPLAYS

Monitors pH and ORP and displays programmed set points.

The Digital Display numbers will flash if Consecutive Feed Alert Limit is exceeded.

#### 5- pH STANDBY LAMP AND PROGRAMMING BUTTONS

When pH standby lamp is illuminated the six set buttons are enabled.

#### 6- MODE BUTTON AND AUTOMATIC LAMP

Press MODE button to pH or ORP and hold for 2 seconds for OFF.

Press and release MODE button to step from pH to ORP.

Press again to return to AUTOMATIC mode.

#### 7- ORP STANDBY AND PROGRAMMING BUTTONS

When ORP standby lamp is illuminated the five SET buttons are enabled.

#### 8- pH/ORP SENSOR CONNECTORS – BNC type

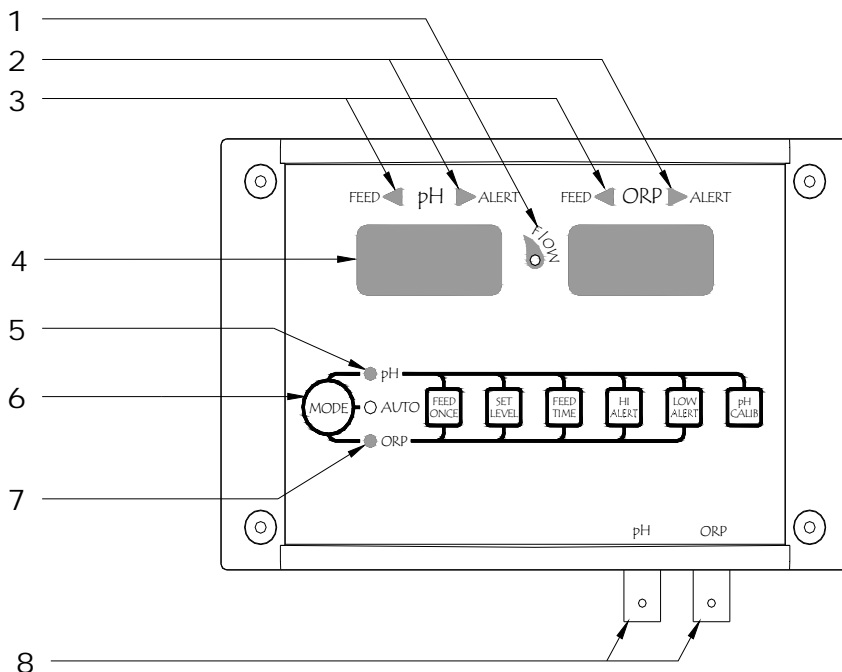



**Modes:** The controller has four modes of operation:

- ON/OFF mode.
- AUTO mode – normal operation mode
- pH - setting mode
- ORP - setting mode

To move from one mode to another simply press the MODE button.

The illuminated lamp indicates the current mode.

### **3.3.1 On/off mode:**

- To turn the controller “ON”: press the MODE button.
- To turn the controller “OFF”: press and change MODE to pH or ORP and hold the MODE button for two seconds until both displays read “OFF”. Release the MODE button and the controller turns off and the displays go blank.

Note: Turning the controller “OFF” using the MODE button simply turns off the controller functions, but does not turn off the power to the controller. The ‘FLOW’ lamp located at the center of the controller is both the power light and a flow indicator when an optional flow switch is used.

**3.3.2 AUTO mode:** This is normal operation mode. The controller operates the respective feeders to automatically maintain the parameters set for both pH and ORP.

**3.3.3 pH SET mode:** This enables the six programming buttons to set desired pH parameters.

Note: When scrolling through the set modes, to reverse the direction simply release the button momentarily and press the button again.

**Feed Once button:** By pressing the FEED ONCE button, the pH feeder will feed and delay for one complete feed cycle. See FEED TIME Button for feed/delay times. If the Feed time is set for “Continuous feed” the manual feed will not operate.

**Set Level button:** Pressing the SET LEVEL button once will display the current set level. To change the set level, press and hold the SET LEVEL button (which displays in 0.1 pH increments) until the desired level is reached.

**Feed Time:** The feed times are displayed in seconds.

Each feed cycle includes a five (5) minute delay time. Pressing the FEED TIME button allows the user to scroll through the available feed times. Release the button when the desired pH feed time is reached. To set the controller in Continuous feed, release the button when the display reads “con”. Continuous feed runs feeder continuously; (1) until set point is reached or (2) until Consecutive Feed Alert Limit is reached or (3) until Hi/Low Alert limit is reached. See appendix for Consecutive Feed Alert Limit details. Feed time can also be set to “off”.

Note: The controller will overshoot the pH Set Level by 0.1 to reduce on/off cycles.

**Hi Alert:** Pressing the HI ALERT button allows the operator to set or turn off the HI alert level feature. As the button is pressed the pH readout will scroll through the available HI alert pH levels (7.5 to 8.4 and off). Release the button when the desired level is reached. The Hi Alert cannot be turned off in the BASE feed selection.

**Low Alert:** Pressing the LOW ALERT button allows the operator to set or turn off the Low alert level feature. As the button is pressed the pH readout will scroll through the available Low alert pH levels (6.8 to 7.4 and off). Release the button when the desired level is reached. The Low Alert cannot be turned off in the ACID feed selection.

Note: If the pH reading is out of the pre-set alert range for more than ten (10) minutes the pH red alert lamp will illuminate and the pH feeder will be disabled. The system will automatically reset when the water chemistry has been corrected.

**pH Calibrate:** This button allows the operator to calibrate the pH sensor to a buffer or to a sample tested with a test kit. Pressing the pH CALIB button allows the operator to adjust the pH reading to match the buffer or test kit value.

Note: The sample to be tested should always be taken from the flow cell or container in which the pH sensor is located. The pH calibration allows the adjustment of +/- 1 pH in .1 pH increments.

**Consecutive Feed Alert Limit:** The Digital Display numbers will flash and the pump/feeder will not activate if the Set Level is not reached within the preset Consecutive Feed Alert Limit. See appendix for setting Consecutive Feed Alert Limit.

**3.3.4 ORP SET mode:** This enables the first five programming buttons to set desired ORP parameters.

**Feed Once:** By pressing the FEED ONCE button, the ORP feeder will feed and delay for one complete feed cycle. See FEED TIME Button for feed/delay times. If the feed time is set for "Continuous feed" the manual feed will not operate.

**Set Level:** Pressing the SET LEVEL button once will display the current set level. To change the set level, press and hold the SET LEVEL button (which displays in 5 mV increments) until the desired level is reached.

**Feed Time:** The feed times are displayed in seconds. There is a five (5) minute delay time associated with each feed time. Pressing the FEED TIME button allows the user to scroll through the available feed times. Release the button when the desired ORP feed time is reached. To set the controller in Continuous feed mode, release the button when the display reads "con". Continuous feed runs feeder continuously; (1) until set point is reached or (2) until Consecutive Feed Alert Limit is reached or (3) until Hi/Low Alert limit is reached. See appendix for Consecutive Feed Alert Limit details. Feed time can also be set to "off".

Note: The controller will overshoot the ORP Set Level by 10mV to reduce on/off cycles.

**Hi Alert:** Pressing the HI ALERT button allows the operator to set or turn off the HI alert level feature. As the button is pressed the ORP readout will scroll through the available HI alert ORP levels (650 mV to 900mV, preset at 900 mV). Release the button when the desired level is reached.

**Low Alert:** Pressing the LOW ALERT button allows the operator to set or turn off the Low alert level feature. As the button is pressed the ORP readout will scroll through the available ORP levels (100 mV to 640 mV in 5 mV increments and "OFF"). Release the button when the desired level is reached. The pH CALIB button is not functional in the ORP mode.

Note: If the ORP reading is out of the pre-set alert range for more than ten (10) minutes the ORP red alert lamp will illuminate and the ORP feeder will be disabled. The system will automatically reset when the water chemistry has been corrected.

**Consecutive Feed Alert Limit:** The Digital Display numbers will flash and the pump/feeder will not activate if the Set Level is not reached within the preset Consecutive Feed Alert Limit. See appendix for adjusting Limit.

## 4. Installation

### 4.1 Locating the Controller

Install the chemical pump and erosion feed systems as shown in manuals included with the feeders. The controller may need to be set for the particular feeder system used. Before installing the controller, it is important to do a site assessment to consider where and how you will mount the unit. The controller should be mounted on a wall or other surface within eight feet of the feeder, at least ten feet away from the edge of the water, and within six feet of the GFCI power source. Never mount a controller above or near an acid tank. Never mount a controller in a location accessible to the public. Install the controller in an area protected from natural elements (sun, rain, freezing, etc.). See appendix for typical feed system schematics.

### 4.2 Mechanical Installation

Once the site is selected, obtain screws or anchors (mounting screws are not provided with controller) to securely mount the controller on the wall or a panel. Install a screw in the wall/panel where the top center of the controller is to be located. Leave  $\frac{1}{4}$  inch of the screw out of the wall to hang the controller from the keyhole located on controller's back. Remove the power panel access cover and install screws through the two holes located at the bottom left and right corners of the controller.

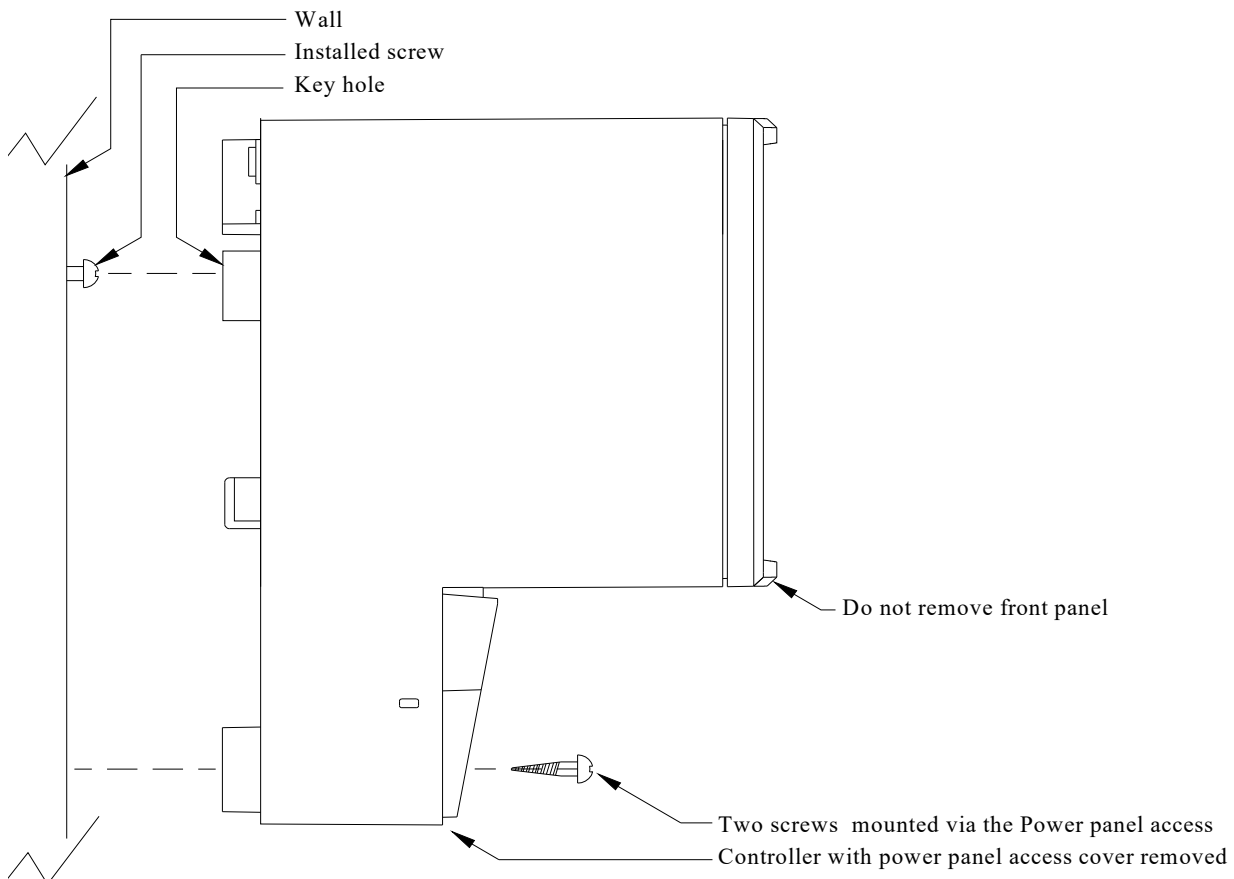

## 4.3 Power panel access

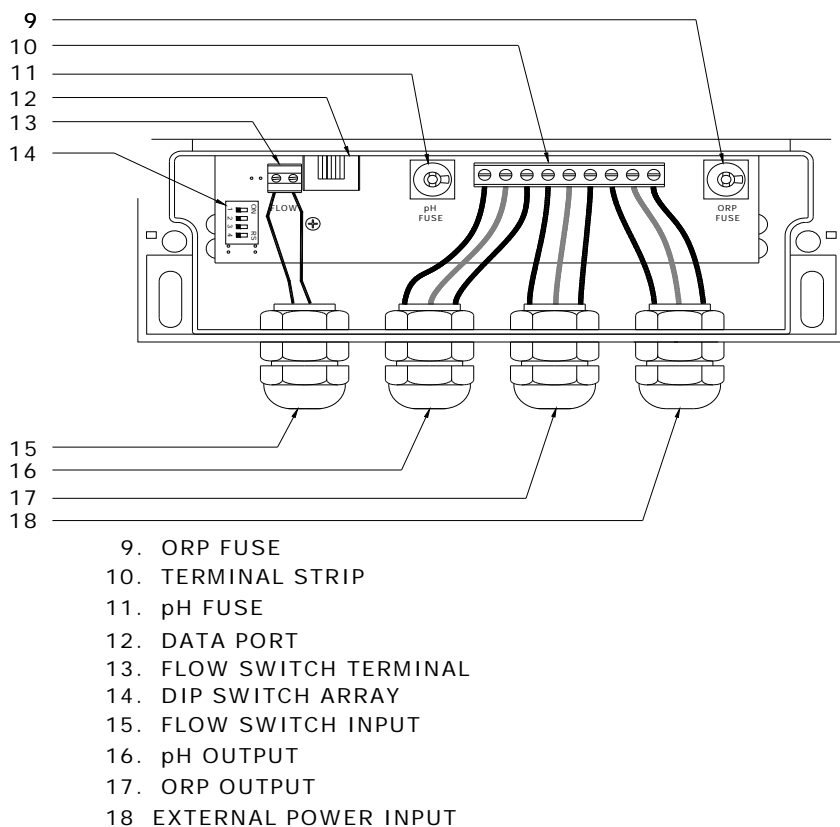

### 4.3.1 Dip switches

The controller has a series of dip switches to control functions that are not normally accessible on the front panel. These dip switches are located inside the power panel access cover. To access switches, remove power from the controller and remove power panel access cover. There are four dip switches- #1 is the top switch. The switch is 'off' when in the left position and 'on' in the right position. See appendix for settings.

### 4.3.2 Fuses

The ORP and pH are independently fused to protect the controller from defective feeders. These fuses are located inside the lower panel. The fuse holders are shipped with 5 amp fuses. (Replacement fuses are 5mm x 20mm Fast Acting IEC.)

### 4.3.3 Flow Switch

The controller has a flow switch terminal located inside the Power Panel Access Cover on the left side. It is shipped with a jumper in place. The terminal must either have the jumper or a flow switch installed.

The flow switch light on the face of the controller is also a power light that shows that the controller is connected to a live power source. If the terminal does not have a closed circuit, the controller will not turn on.

NSF certification of this automated controller requires the use of a flow switch. To install a flow switch, remove the jumper and install the flow switch leads. Note: With the flow switch installed and the jumper removed, the flow light will no longer operate as a power light. It is recommended the jumper be retained to assist in troubleshooting if necessary.

#### **4.3.4 Globe Flowcell** (see Globe Flowcell Operating Manual)

Connect the Globe Flowcell grounding stud to ground in order to prevent erroneous readings and to prevent damage to the probes.

Note: It is recommended that an inline filter be used to help keep the Globe Flowcell (including probes) and flow switch free from debris. Debris may cause obstruction in flow switch and prevent the switch from functioning.

## 5. Operation

### 5.1 Startup

Do not add chemicals to the feeders until all startup operations are completed. Using a DPD test kit, manually adjust and balance the water chemistry to acceptable ranges. Automation should be used to maintain chemical levels, not to balance a pool that is far out of acceptable ranges. With the controller in the OFF mode, turn the filter pump on and check for leaks in the system and flow through the flow cell. The flow lamp will be illuminated if the controller has power, it is connected to the flow switch and there is adequate flow. If a flow switch is not attached, the flow lamp will be illuminated if there is a jumper in the Flow Switch Terminal allowing the controller to be used without a flow switch. Using a flow switch is always recommended.

### 5.2 pH settings

Press and release the controller MODE button until the pH LED is lighted (refer to the description of controls). Then select the desired Set Level, Feed Time and High and Low Alert Levels. Adjust Consecutive Feed Alert Limit if Set Level is not met within preset limit as indicated by the Digital Display flashing. –See appendix for detail.

Note: Controller can be set to feed acid or base. See Acid/Base pH chemical feed section in Appendix for Dip switch settings. To verify that acid feed mode is selected adjust the pH set level below the pH indicated on the display. The feed lamp should come on if the controller is in acid feed mode. To verify that base mode is selected adjust the pH set level above the pH indicated on the display. The feed lamp should come on if the controller is in base feed mode.

### 5.3 pH Calibration

The pH sensor can drift slightly over time and calibration will offset this drift. Always calibrate using water from the sample port of the flow cell and use an independent pH test method to determine pH value of sample, unless using preset buffer solution. Press and release the controller MODE button until the pH LED is lighted (refer to the description of controls). Then use pH CALIB button to adjust reading to match known pH value of sample. It may take up to 24 hours for the sensors to acclimate to the system so recalibrate 24 hours after the first calibration. The pH sensor calibration should be checked every four to six weeks. If calibration is required more often then probe may need cleaning or replacement.

### 5.4 ORP settings

Press and release the controller MODE button until the ORP LED is lighted (refer to the Description of Controls section). Then select the desired Set Level, Feed Time and Hi and Low Alerts. Adjust Consecutive Feed Alert Limit if Set Level is not met within preset limit as indicated by the Digital Display flashing. –See appendix for details.

The ORP display indicates the effectiveness of the sanitizer; it does not directly correlate to a chlorine ppm reading. To determine your ORP set level, manually adjust and balance the pool to be within acceptable ranges. Use a DPD test kit to confirm the free chlorine level. Use the ORP reading of the balanced pool as your ORP set level.

## 5.5 Operating mode

Press and release the MODE button until the AUTO LED is lighted. This is the operational mode for the controller. The controller must be in this mode for the feeders to maintain the desired parameters.

Note: When using the RC554XP or 554000 controller with ROLA-CHEM pumps, the pump switch should be in the CONTINUOUS position (not Timed or Off).

If the sanitizer level is too low or high, adjust the ORP set level up or down in small increments (for example 10mV to 25 mV increments) to lock in the desired sanitizer level.

Note: The ORP reading is highly dependent on both the pH and the cyanuric acid levels. Both of these variables must be kept within acceptable ranges to maintain an acceptable relationship between the ORP and the ppm of the sanitizer.

Note: Low feed rates can cause the feeder to lag or feeding to be extended. A high feed rate can result in too much chemical being added.

If using timed feed cycle, the feed lamp will flash during the feed time and be lit continuously during the delay time of the feed cycle. If over feeding is occurring, consider using a shorter feed cycle.

In Continuous feed, the feed lamp will flash while feeding.

When an alert lamp is on indicating readings below or above the alert settings the pump/feeder will not activate. The Digital Display numbers will flash and the pump/feeder will not activate if the Set Level is not reached within the preset Consecutive Feed Alert Limit. See appendix for adjusting Limit.



## 6. Troubleshooting

### 6.1 Chemicals not feeding

- \* FLOW light on Controller must be illuminated.  
Check flow switch in Globe Flowcell if light is not on.
- \* Feeder power and time switches must be in 'CONTINUOUS' position.  
Check feeder by using alternate power source.
- \* Factory setting for feed time is 0.6 sec on with 5 minute delay.  
Feeders may require longer feed time.
- \* Chemical reading has met Set Level.

### 6.2 Displayed chemical level does not correspond to actual level

- \* ORP=0, pH=6.0 indicates sensors (probes) are attached to incorrect connector
- \* Sensors (probes) need cleaning. (see Globe Flowcell Operating Manual)
- \* Sensors (probes) need replacing.  
Note: ORP probe reading can be affected by a failing pH probe.  
Both probes must be in good operating condition.
- \* Connect Globe Flowcell ground stud to ground. (see Globe Flowcell Operating Manual)

### 6.3 Set Level not being reached/maintained

- \* Factory setting for feed time is 0.6 sec on with 5 minute delay. Feeders may require longer feed time. If time is too short, set-points will not be maintained. If feed time is too long, overfeeding chemicals may occur. Correct time is dependent on multiple factors such as pool/spa water volume, feeder output, chemical concentration and chemical needs.
- \* Factory setting for Consecutive Feed Alert Limit is 20 cycles for timed feed mode or 20 minutes for continuous feed mode. If set level has not been reached within this adjustable limit the Digital Display numbers will flash and pump/feeder will be disabled. If set level cannot be met within this limit then higher limits may be required. See appendix for adjusting Limit. If Limit is set too high, overfeeding chemicals may occur.
- \* Controllers are designed to maintain set-points. Do not expect controllers to make major adjustments—major changes should be done manually.
- \* Pump/feeders must be large enough to reach desired set-points in a relatively short time. Automation using controllers may require larger feeder or more concentrated chemicals than system that uses continuous time controlled feeding (i.e. feeders only).

## 6.4 Error Code displayed

If an error code appears in the display the controller can be reset by following this procedure.

- A. Unplug power from controller.
- B. Simultaneously depress and hold SET LEVEL and pH CALIB buttons.  
While they are depressed, plug in controller power cord.  
The displays will read "Ld" and then turn On.
- C. Release the buttons.
- D. The controller is now in test mode. Test mode reduces the feed delay time from 5 minutes to 5 seconds to simplify diagnostics.
- E. Turn the controller Off again to exit test mode.  
Press MODE to ORP or pH.  
Hold MODE button until display reads "oFF".  
Release the MODE button. Only the flow light should be on.
- F. Press MODE to turn the controller On and return to operating mode.

The last two steps are extremely important because this puts the controller back in operating mode. If these two steps are not performed the controller will remain in test mode and it will not operate properly.

If an error code continues to appear contact ROLA-CHEM service personnel.

## 6.5 Digital Display numbers flashing

- \* Consecutive Feed Alert Limit has been reached. See appendix for Consecutive Feed Alert Limit details.
- \* Adjust feed time as needed.

## 6.6 Alert light illuminated

- \* Hi/Low alert limit has been reached.
- \* Adjust feed time or alert settings as needed.

## 6.7 Feed Once button does not work

- \* Feed Once button will not operate if the feed time is set for "Continuous feed".
- \* Feed Once button will not operate if controller is in auto Mode. Controller must be in ORP or pH mode.

## 6.8 Globe Flowcell / Probe / Flow Switch troubleshooting

- \* See Globe Flowcell operating manual.

## 7. Warranty and Service

### Limited Warranty:

ROLA-CHEM warrants the original purchaser that this unit is free from manufacturing defects in material and workmanship from the date of the original purchase for five (5) years.

If this unit fails within the five (5) year period it will be repaired or replaced (ROLA-CHEM's option) at no charge when returned to ROLA-CHEM with proof of purchase receipt. This warranty does not apply to any product damage caused by improper use, accident, misuse, improper line voltage, fire, flood, lightning, earthquake, other acts of nature, or if product was altered or opened by anyone other than qualified ROLA-CHEM personnel.

Effective date for this limited warranty – January 1st, 2019.

All expendable items (probes, flow switch, flow cell, valves, feeders, tubing, etc.) are not covered under this warranty.

Heavy duty probes are warranted from the date of original purchase for one (1) year.

ROLA-CHEM under no circumstances shall be liable for any consequential damages directly or indirectly caused by this unit. Please observe all rules and regulations required by state and local regulations, building codes, health codes, OSHA, etc.

**Service Procedure:** For operation assistance in the United States please call: (800) 549-4473 and ask for Customer Service, Monday through Friday 8:00 am-5:00 pm Central Time or email: [info@rola-chem.com](mailto:info@rola-chem.com). Have model number and serial number available.

ROLA-CHEM has specialized knowledge and equipment to test and diagnose your product. Contact our service personnel as noted above for assistance. If you are directed to ship the product to ROLA-CHEM and given an RGA#, please note RGA# on the package and ship freight pre-paid to:

ROLA-CHEM  
5858 Centerville Road  
St. Paul, MN 55127-6804

[www.rola-chem.com](http://www.rola-chem.com)

## 8. Appendix

### 8.1 Dip switch settings

The controller has dip switches to control functions/options that are not accessible on the front panel. These dip switches are located inside the power panel access cover. Slide switch right for ON or left for OFF. See section 4.3.

#### **Switch #1 OPR/pH interlock**

#1 OFF - ORP chemical feeding is independent of pH feeding and range.

#1 ON factory setting - ORP chemical feeds only when pH is within set limits. ORP chemical will not feed when pH chemical is feeding.

#### **Switch #2 Consecutive Feed Alert Limit**

**Setting consecutive feed alert limit to OFF voids NSF certification. If limit is set too high, overfeeding may occur.**

**Timed feed Mode** (Feed time set to a value other than “con” or “off” on Controller front panel)

#2 OFF – There is no consecutive feed limit.

#2 ON factory setting – The pH and ORP chemical feeder outputs go through a preset number of consecutive feed cycles before feeders are disabled. If preset count is reached for either pH or ORP, the respective feeder outputs will be disabled and its display will flash indicating a Consecutive Feed Alert.

The Consecutive Feed Alert cycle limit can be set from 20 to 100 (default is 20) on model RC554XP and can be independently set for both pH and ORP. The available range on model 554000 is 3 to 20 (default is 10).

To adjust the Consecutive Feed Alert Limit feature in the 'timed feed mode'

- 1) Turn off & remove power, then move #2 dip switch to ON.
- 2) Re-power & press MODE to set it for ORP or pH.
- 3) Note feed time setting then Set FEED TIME to OFF.
- 4) Press FEED ONCE button to select the consecutive feed cycle limit.
- 5) Press FEED TIME to return the feed time to the previous setting.

**Continuous feed Mode** (Feed time set to “con” on Controller front panel)

#2 OFF – There is no consecutive feed limit.

#2 ON factory setting - The pH and ORP chemical feeder outputs continuously feed for a preset time before feeders are disabled. If the preset time period is reached for either pH or ORP, the respective feeder output will be disabled and its display will flash indicating a Consecutive Feed Alert.

The Consecutive Feed Alert Limit period can be set from 20 to 180 minutes on model RC554XP (default is 20) and can be independently set for both pH and ORP. The available range on model 554000 is 10 to 99 (default is 10).

To adjust the Consecutive Feed Alert Limit feature in the 'Continuous feed mode'

- 1) Turn off & remove power, then move #2 dip switch to ON.
- 2) Re-power & press MODE to set it for ORP or pH.
- 3) Set FEED TIME to 'con'.
- 4) Press FEED ONCE button to select the continuous feed time limit.

#### **Switch #3 Acid/Base pH chemical feed**

#3 OFF factory setting – Unit set to feed acid chemical when pH is over set level.

#3 ON – Unit set to feed base chemical when pH is under set level.

#### **Switch #4 Keypad Lockout**

#4 OFF factory setting – Keypad operable to set controller parameters

#4 ON – Keypad operable only for pH calibration. Other parameters stay at settings established prior to moving dip switch #4 to OFF.

## 8.2 Factory Default Setting

**Reset:** The controller can be reset at any time to the default factory settings.

The factory presets are:

ORP set level: 650mV

pH set level: 7.4

ORP alerts: high- 900 mV, low- 100 mV

pH alerts: high- 8.0, low- 7.0

Feed time: 0.6 seconds

Consecutive Feed Alert Limits: 20 cycles for timed feed mode or 20 minutes for continuous feed mode

Note: Record current settings before performing reset.

**To reset factory default settings, follow these steps:**

A. Press MODE to ORP or pH.

Hold MODE button until display reads "oFF".

Release the MODE button. Only the flow light should be on.

B. Simultaneously depress and hold SET LEVEL and pH CALIB buttons.

While they are depressed, press the MODE button.

The displays will read "Ld" and then turn On.

C. Release the buttons.

D. The controller is now in test mode. Test mode reduces the feed delay time from 5 minutes to 5 seconds to simplify diagnostics.

E. Turn the controller Off again to exit test mode.

F. Turn the controller On to return to operating mode.

The last two steps are extremely important because this puts the controller back in operating mode. If these two steps are not performed the controller will remain in test mode and it will not operate properly.

## 8.3 Water Chemistry Ranges

**(These ranges are in accordance with suggested NSPI Standards for swimming pools.)**

**pH:** 7.4-7.6

**Alkalinity:** Approx. 80-120 ppm \*\* (parts per million)

Higher levels may be acceptable in areas where it naturally occurs in the local water supply. Consult a pool professional in your area.

**Cyanuric Acid:** 0-50 ppm.

(Maintain at 30 ppm or less for best probe life.)\*

**TDS (Total Dissolved Solids):** 300-2000 ppm

**Calcium Hardness:** 200-400 ppm

**Free Chlorine:** 1.0-3.0 ppm (> 700 mV ORP)

\*20-30 ppm of cyanuric acid provides approx. 95% of the shielding effect for chlorine.

\*\*When using tri-chlor, recommended alkalinity is 95-125 ppm.

## 8.4 Typical System Installations

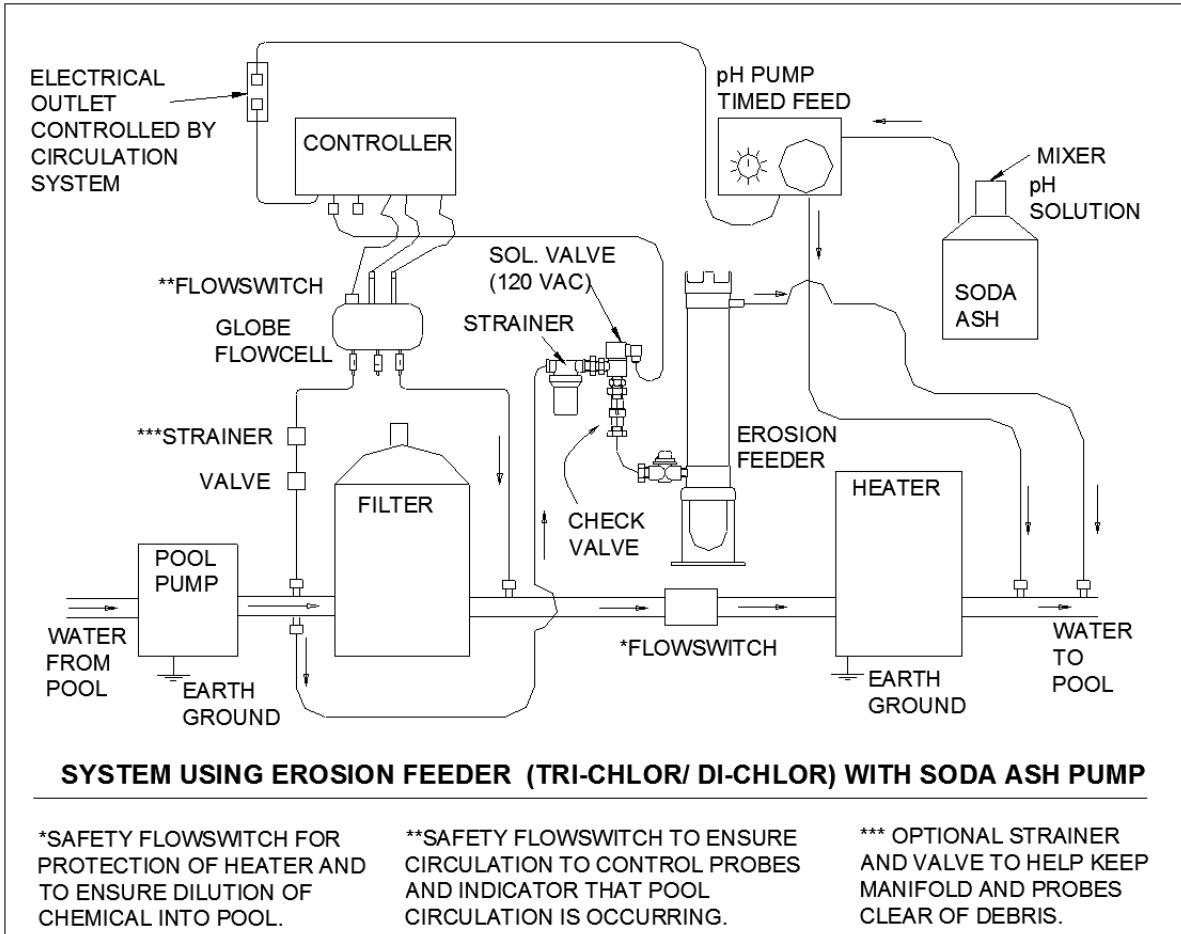
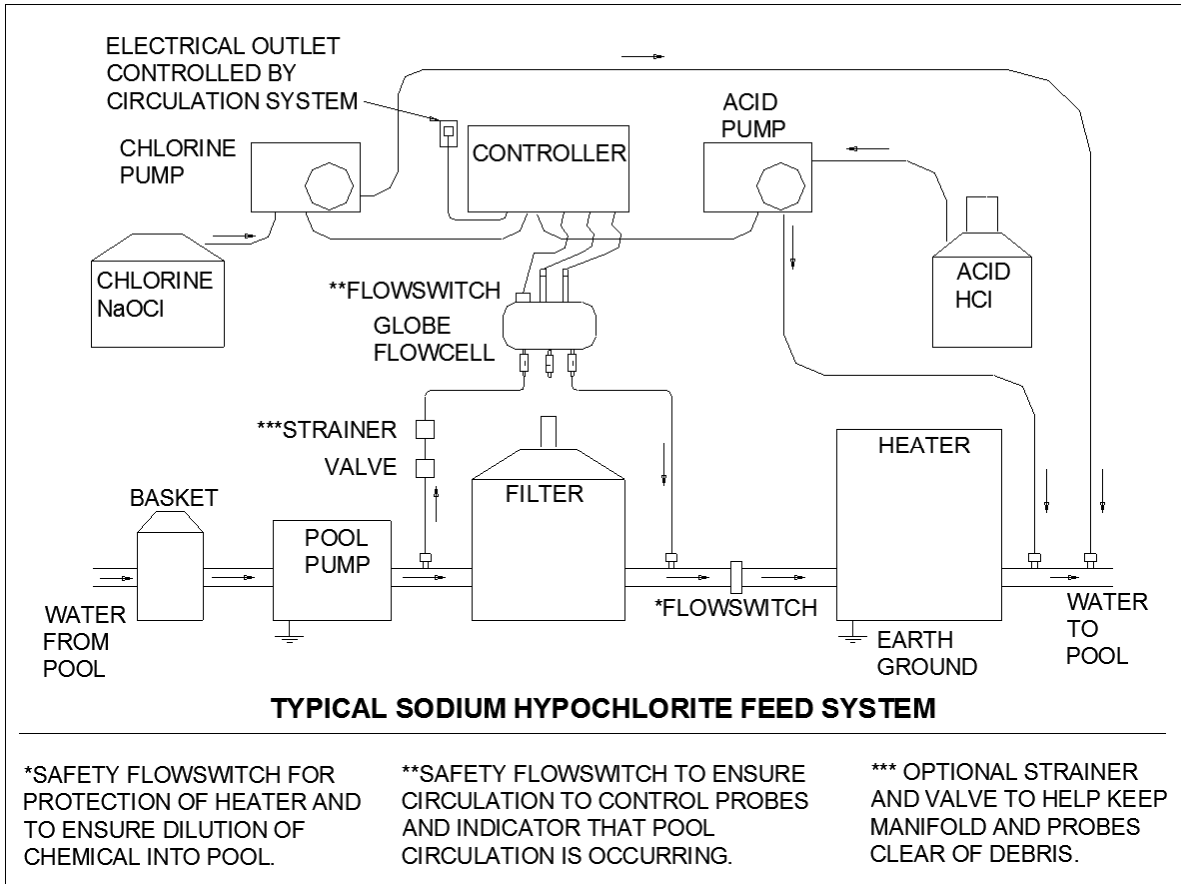

## 8.4 Typical System Installations, cont.,

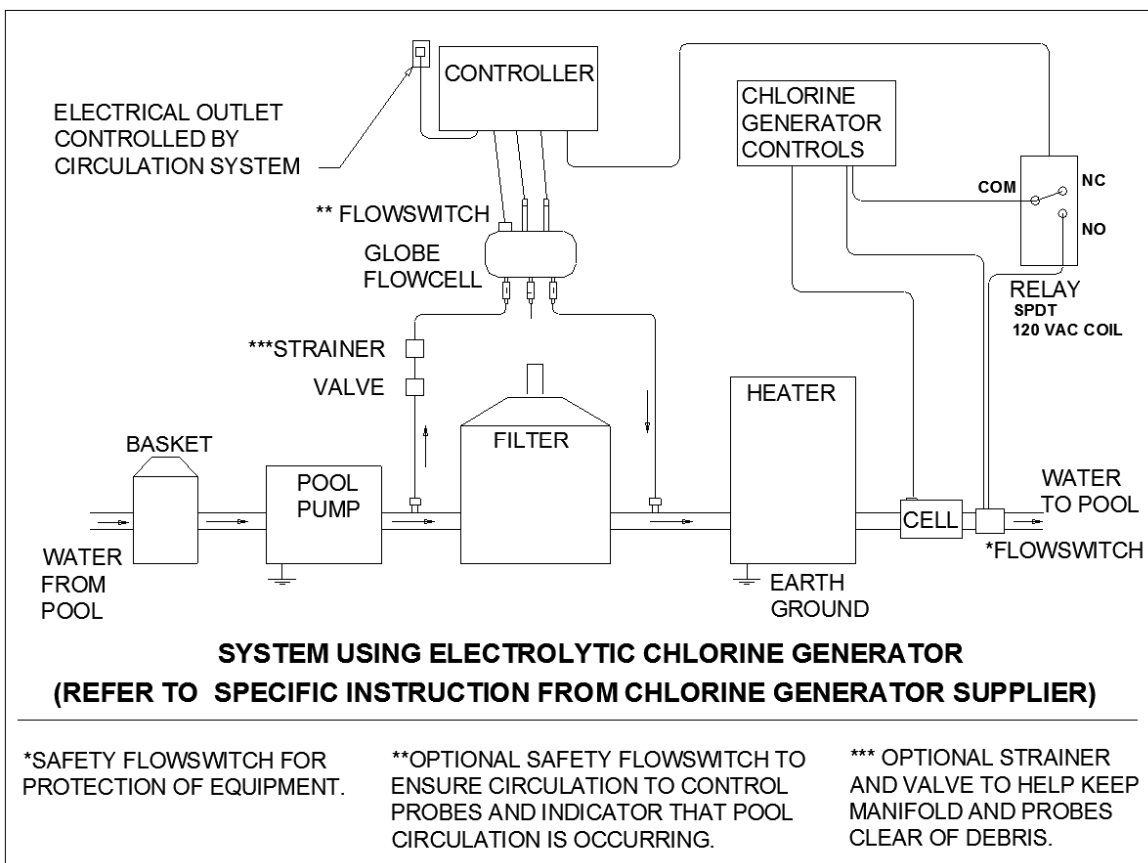
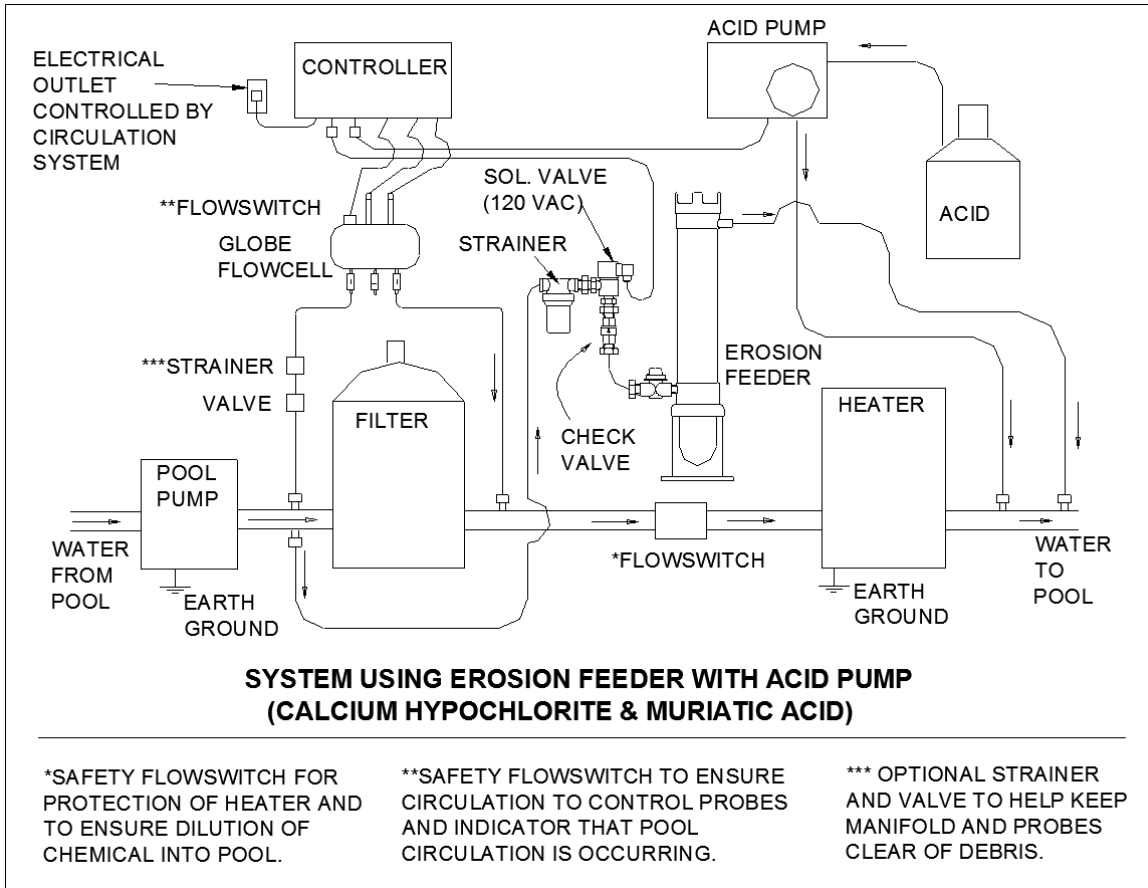

**-NOTES-**