

PROFESSIONAL GAS POOL AND SPA HEATER

STAINLESS STEEL
DESIGN

EASY TO USE
CONTROLS

READY TO
INSTALL



Raypak[®]
A Rheem[®] Company

NO ONE PUTS MORE INTO THEIR POOL HEATERS

Introducing the Raypak Professional series pool heaters, designed specifically for commercial properties such as apartments, condos, hotels, motels, schools, parks, community and high-end private pools. It's also the perfect heater for tough coastal weather conditions where salt air challenges durability. When your reputation is on the line every day, you've got to work smart and come prepared with strength, experience, and the guts to lead the way. In a word, it demands a Raypak Professional series pool heater.



PROFESSIONAL HERITAGE



Built by a company dedicated to water heating and refined through more than seven decades of year-round demanding use in commercial boiler rooms, Raypak heaters embody the durability, longevity and flexibility that the true pool Professional expects. Many of the Professional pool heater features come directly from our commercial boiler experience. This knowledge and experience is unmatched in the pool heating industry.

A DIGITAL CONTROL SO SOPHISTICATED, YET SO SIMPLE TO USE

Microprocessor-Controlled Thermostat

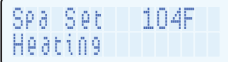

Spa Set 104F
Heating

The Raypak Professional gas heater is equipped with a microprocessor-based control. This control allows you to set your pool and spa temperature precisely

at your preferred setting just by pressing an up or down temperature control button. The digital display tells you when the water is being heated and notifies you when your target temperature has been reached.

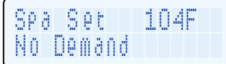

Spa Set 104F
No Demand

Self-Diagnostic



Spa Set 104F
Sensor Failure

Troubleshooting a Raypak gas heater has never been easier. The Raypak Professional has on-board diagnostic controls that

let the user and the service professional know what is going on with the heater at all times. The display uses real English, with no cryptic codes to decipher.

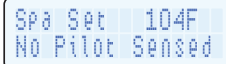

Spa Set 104F
No Pilot Sensed

Remote-Compatible

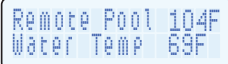

Remote Pool 104F
Water Temp 69F

The Raypak Professional is compatible with most major pool control and remote systems on the market today. Any two- or three-wire remote can connect to the

Raypak Professional and be integrated into the pool control system of your choice. The display clearly shows the heater is under control of a remote system.

Run Time and Cycle Meter



Run Time 100h
Cycles 134

In yet another industry first, the Raypak pool heater can report how long it has run and how many times it has fired. This is valuable feedback for the service

professional. Multi-unit installations can monitor the run time of each unit and balance out the duty load, thus avoiding over working one individual heater.



Flame Strength Indicator

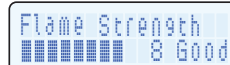

Flame Strength
8 Good

Raypak leads the way with the first control in the pool industry to monitor and measure the pilot flame signal. Known for our high quality, leading edge commercial boilers, it just made sense for Raypak to use this existing commercial technology on our residential pool heaters. This little tool is a service tech's dream. Raypak also uses this function on the end of line test, making sure every heater leaves with a robust flame signal.

On Board Voltmeter

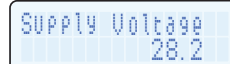

Supply Voltage
28.2

The Raypak Professional monitors the low voltage electrical supply. This helps ensure the heater is wired properly during installation.

The heater will also let you know if the voltage has dropped too low to function properly. No other pool heater takes care of you like a Raypak.



Spa Set 104F
Low Voltage

THE MOST ROBUST AND FORGIVING BURNER EVER INVENTED



Stainless Steel Burners

Burner design is a critical component in any gas heater. The stainless steel burner system used in the Raypak Professional is inherently forgiving and extremely robust. The burner is self-adjusting to compensate for gas pressure fluctuations, meaning the burners will always burn clean and safe. Only Raypak delivers you a pool heater that can withstand wide daily gas pressure fluctuations and keep on burning clean. This burner design is the cornerstone of Raypak's gas-fired products, this same burner has been a part of in our products for over 50 years. It's nice to know that on commercial applications that share a common gas line, the Raypak Professional will run perfectly no matter what the load demand on the total system is.

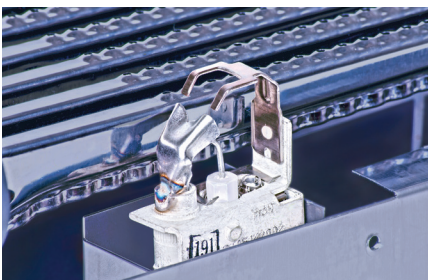

Smooth Light Off

The slow-opening gas valve ensures smooth turn-on; no "Hard Light" to worry about. The easily removable burner tray and pilot assembly make service and maintenance a simple task. Every component of the burner is stainless steel, except for the powder coated gas manifold.

Pilot Ignition

The Raypak Professional uses a spark-to-pilot ignition system. This is the most reliable and robust ignition system available—an industry proven standard for well over 30 years.

THE HEART AND SOUL OF THE RAYPAK PROFESSIONAL

Rust-Free Waterways

Raypak has applied its years of commercial boiler experience to the design of the bronze header. A metal header design allows for the higher working pressures required by ASME. Only after the material meets the stress analysis and metal composition tests is it approved for use in an ASME unit.

ASME CuproNickel Fin Tube

The Raypak Professional is designed specifically to meet State and local code requirements for public pools and commercial applications. The heater is equipped with a thicker walled fin tube allowing it to meet the ASME requirements. The Raypak Professional comes standard with cupronickel fin tube heat exchangers for added protection against aggressive water chemistry. Although rare, there are certain applications, like health club spas, where copper is just not the best choice. Cupronickel offers superior tolerance to bad and fluctuating water chemistry, thanks to a harder surface and a thicker walled fin tube. Cupronickel has also shown superior corrosion resistance in salt chlorine generated pools.



Bronze headers and CuproNickel tubes -standard

Condensation Reduction

Both water temperature and flow rate inside the heater are controlled to help eliminate condensation, sooting and scale buildup that can shorten the life of a heater. Raypak engineered the Unitherm Governor specifically for pool heater applications, regulating low-temperature incoming water to help reduce condensation. The built-in automatic bypass helps prevent scaling and erosion by balancing the flow going into the heat exchanger.

THE MYSTERY OF ASME UNCOVERED

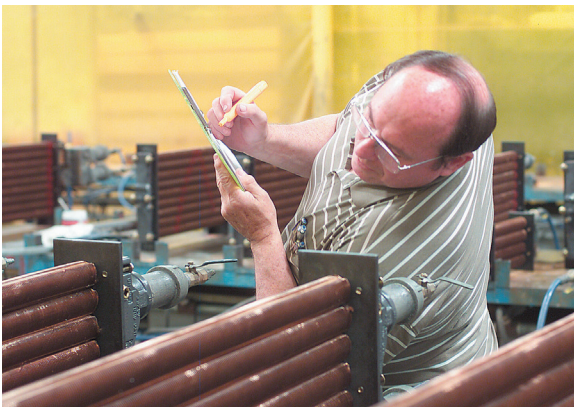

On-site state inspectors

ASME stands for American Society of Mechanical Engineers, a non-profit group which sets many industrial and manufacturing standards. A pool heater that is made to ASME standards must conform to a set of specifications as determined by ASME, specifically in relation to the operating water pressure the appliance can handle. Each and every ASME heat exchanger that goes into a Raypak Professional heater is inspected by a state inspector to make sure it complies with ASME Code.

That's why Raypak is the only pool heater manufacturer to supply a flow switch and T&P gauge standard with every Professional series gas heater under 400MBTU. We know what it takes to make a unit 50-state ASME compliant right out of the box. Does your heater company make sure all the little details are taken care of like Raypak does?

The Raypak Professional heater comes standard as an ASME stamped unit. Raypak has state inspectors on-site daily performing inspections for our pool heater and commercial boiler production that require ASME. Being in the boiler business for over 70 years truly makes Raypak the leader for your commercial needs. Why ASME? Most local codes require that public pools, pools that are in condominiums, apartments, or other commercial applications, be in compliance with ASME Section IV.

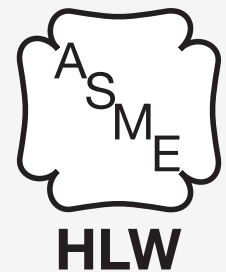

Flow switch and T&P gauge -standard

TOUGH AND LEGENDARY DURABILITY JUST GOT BETTER



MICROPROCESSOR

control is more precise than mechanical systems. It controls temperatures for pool and spa settings and stores diagnostic information for service technicians.



STAINLESS STEEL

is used liberally through-out the Professional series pool heater. Raypak spared no expense to ensure that any area that could be compromised by harsh environments would stand the test of time.



HEAT EXCHANGER

with bronze headers and cupronickel tubes for maximum protection against the toughest pool applications. Excellent for salt chlorine generated pools.

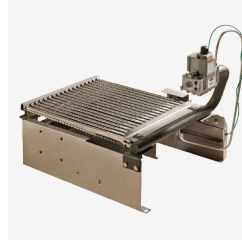

BURNER TRAY

constructed entirely of stainless steel. Every detail has been looked at, down to every nut and bolt, and made of stainless steel. This burner tray is built to last.

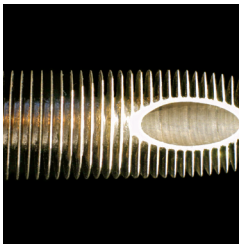

CUPRONICKEL FIN TUBE

is at the heart of the Raypak Professional series heater. The competition doesn't stand a chance against its fat .065 tubing walls. Raypak also uses integral fin tube, meaning it's all one piece of material.



SPARK TO PILOT

is the most reliable and safe ignition system in use today. For over 40 years Raypak has enjoyed reliable performance with a gas pilot system. Some things just don't get any better.

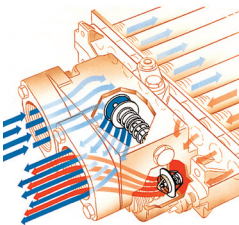

CONDENSATION DEFENSE

has been a Raypak tradition for over 55 years. We utilize our Unitherm Governor system along with a spring loaded bypass to maintain the required flow through the heat exchanger.



ATTENTION TO DETAIL

was the main goal in designing the Professional heater. Every aspect was evaluated and changed to stainless steel when any question of corrosion was a concern.



FLOW SWITCH AND T&P

are standard equipment on the Raypak Professional. This makes the unit 50 state ASME compliant right out of the box. Also, having a flow switch eliminates pressure issues from elevated pools.



ROBUST BURNER

design is Raypak's speciality. The Professional series heater can withstand fluctuating and varying gas pressures. The burner is self-adjusting and always yields a perfect flame.

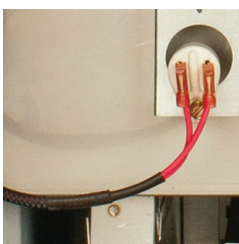

WIRING SHEATH

is standard construction on all exposed wiring. This helps against rodent damage and other associated issues that can damage the wiring. Not to mention it looks very clean and tight.



WARRANTY

The Raypak Professional is unmatched in warranty for commercial applications: Three years parts and labor and additional 2 years parts on the heat exchanger years four and five. We stand behind what we believe in.

Technical Data

Professional Gas Pool Heaters

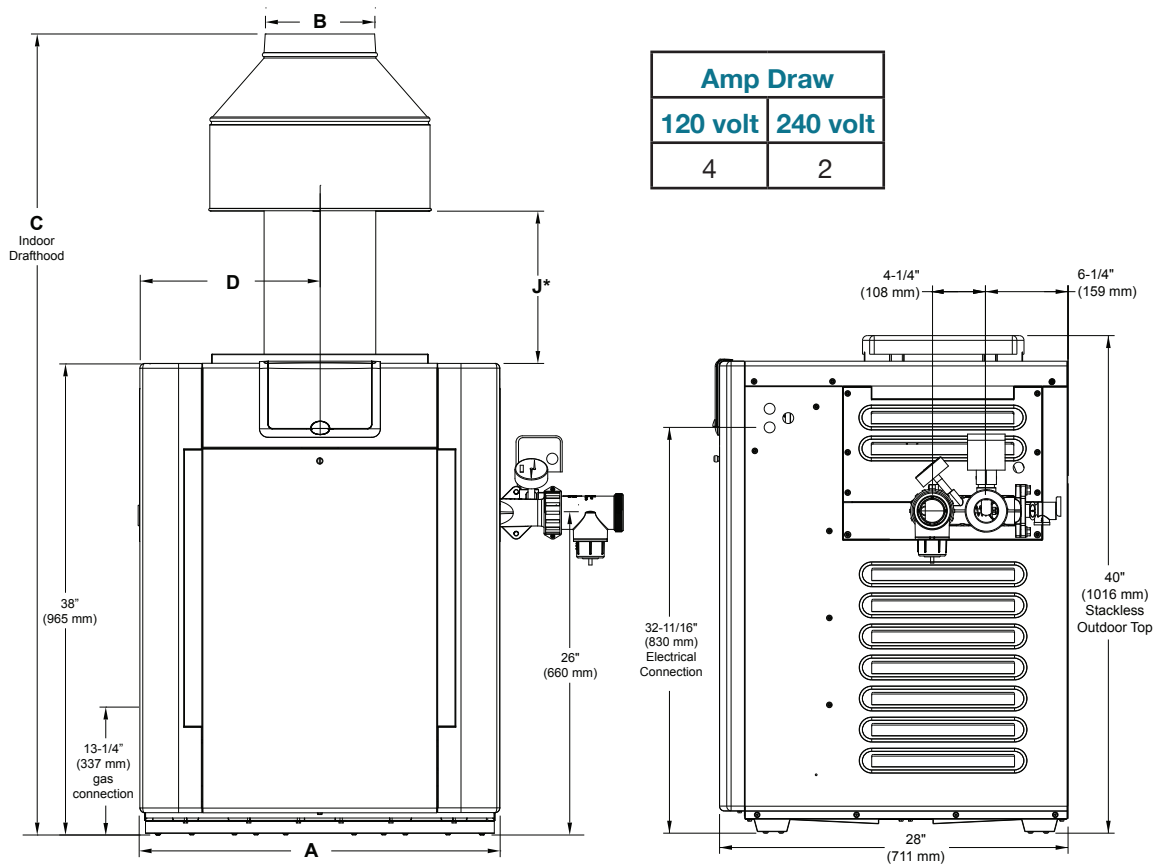

Amp Draw	
120 volt	240 volt
4	2

Heater Model	BTUH Input (000)	(A) Cabinet Width	(B) Flue Dia.	(C) Indoor Draft-hood	(D)	(J) Minimum	Gas Conn.	Water Conn.	Shipping Weights (lbs)	
									w/ Bronze Headers and Stackless Top	Indoor Draft-hood
R268A	266.0	23"	7"	62"	11-1/2"	11"	3/4"	2"	229	16
R408A	399.0	29"	9"	64-9/16"	14-1/2"	12-1/8"	3/4"	2"	268	21

Designation for a Professional heater using propane gas is "EP"; a Professional heater using natural gas is "EN".

Prefix "B" is for bronze (ASME) headers.

Suffix "X" is for cupronickel tubing

Example: B-R408A-EN-X = Bronze headers, 408 model size, digital, natural gas, cupronickel

Reduce input 4% for each 1000 feet above sea level when installed above 2000 feet elevation.

Heater can be installed directly on a combustible surface.



www.raypak.com

2151 Eastman Avenue | Oxnard, CA 93030 | 805-278-5300