

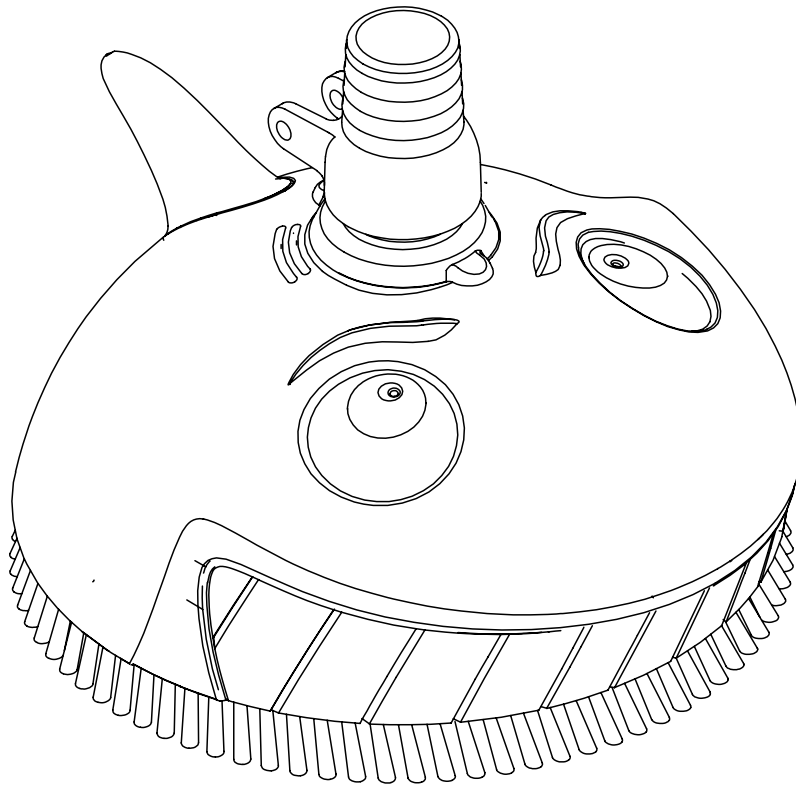

KREEPY KRAULY® 'LIL SHARK™

ABOVEGROUND POOL CLEANER



ENGLISH 1

FRANÇAIS 7

ESPAÑOL 17

INSTALLATION AND USER'S GUIDE

IMPORTANT SAFETY INSTRUCTIONS
READ AND FOLLOW ALL INSTRUCTIONS
SAVE THESE INSTRUCTIONS

CUSTOMER SERVICE / TECHNICAL SUPPORT

If you have questions about ordering Pentair Aquatic Systems replacement parts, and pool products, please use the following contact information:

Customer Service (8 A.M. to 4:30 P.M. — Eastern and Pacific Times)

Phone: (800) 831-7133

Fax: (800) 284-4151

Web site

visit www.pentairpool.com or www.staritepool.com to find information about Pentair products.

Technical Support

Sanford, North Carolina (8 A.M. to 4:30 P.M. ET)

Phone: (919) 566-8000

Fax: (919) 566-8920

Moorpark, California (8 A.M. to 4:30 P.M. PT)

Phone: (805) 553-5000 (Ext. 5591)

Fax: (805) 553-5515

© 2013 Pentair Aquatic Systems. All rights reserved.

This document is subject to change without notice.

1620 Hawkins Ave., Sanford, NC 27330 • (919) 566-8000

10951 West Los Angeles Ave., Moorpark, CA 93021 • (805) 553-5000

All Pentair trademarks and logos are owned by Pentair, Inc. Pentair Aquatic Systems™, Kreepy Krauly® and 'Lil Shark™ are trademarks and/or registered trademarks of Pentair Water Pool and Spa, Inc. and/or its affiliated companies in the United States and/or other countries. Unless expressly noted, names and brands of third parties that may be used in this document are not used to indicate an affiliation or endorsement between the owners of these names and brands and Pentair Water Pool and Spa, Inc. Those names and brands may be the trademarks or registered trademarks of those third parties. Because we are continuously improving our products and services, Pentair reserves the right to change specifications without prior notice. Pentair is an equal opportunity employer.

P/N 371520 Rev. D 6/11/13

IMPORTANT WARNING AND SAFETY INSTRUCTIONS



Important Notice:

Attention Installer: This guide contains important information about the installation, operation and safe use of this product. This information should be given to the owner and/or operator of this equipment after installation of the pool cleaner.

Attention User: This manual contains important information that will help you in operating and maintaining this pool cleaner. Please retain it for future reference. Consult Pentair with any questions regarding this equipment.

WARNING Before installing this product, read and follow all warning notices and instructions which are included. Failure to follow safety warnings and instructions can result in severe injury, death, or property damage. Call (800) 831-7133 for additional free copies of these instructions.

Consumer Information and Safety

Pentair pool cleaners are designed and manufactured to provide many years of safe and reliable service when installed, operated and maintained according to the information in this manual. Throughout the manual, safety warnings and cautions are identified by the “**▲**” symbol. Be sure to read and comply with all of the warnings and cautions.

WARNING **HAZARDOUS SUCTION.** Do not play with cleaner or hose or apply to body. Can trap and tear hair or body parts. Hose can trip or entangle swimmers which could result in drowning.



WARNING **SUCTION ENTRAPMENT, INJURY, AND DROWNING HAZARD.** If your pool has a dedicated suction port (“vac port”) for vacuuming or for an automatic pool cleaner, it must be covered when not in use. A spring loaded safety cover (a “vac port fitting”) is included with your cleaner. Install it on the suction port to prevent entrapment and injury. If the cover provided does not fit, purchase one that does from your local pool store and install it instead. The cover should conform to IAPMO SPS4-99A.



WARNING **Stop pump** before attempting to clean unit. Do not allow swimmers in pool while pool cleaner is operating.

WARNING To reduce the risk of injury, do not let children use or play with pool cleaner.

WARNING Do not allow swimmers in the pool while pool cleaner is operating. Hose can trip or entangle swimmers which could result in drowning.

WARNING Moving parts may injure hands or fingers. Stop pump before attempting to clean out pool cleaner head.

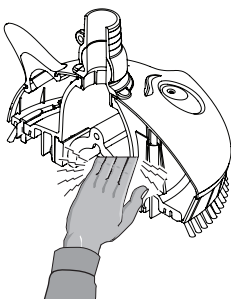

General Installation Information

Pre-Installation Check List

Before installing your cleaner, review and understand all warnings and safety information in this guide. Failure to follow these instructions or improper installation of the cleaner can result in damage to the pool finish or the vinyl liner, Pentair Aquatic Systems disclaims any liability for repairs or replacement to any of these structures or components of the customer’s pool.

Before installing the cleaner in a vinyl liner pool:

Check liner closely for signs of deterioration or damage from age, chemicals, pool wall damage, etc. If any damage is found, have a qualified pool professional make all the necessary repairs. Also, if there are stones, roots, etc., under the liner, remove them before installing the cleaner.

Before installing the cleaner in a gunite pool or a pool that is partially or completely tiled:

Repair loose tiles and tighten any loose light rings.

Before installing the cleaner, clean your filter system:

Make sure you have cleaned the filter, including backwashing, rinsing, and emptying all baskets. A clean system is necessary for proper cleaner operation and coverage.

Before installing the cleaner, understand cleaner coverage:

The cleaner is designed to rid your pool of debris in approximately 4-6 hours. Less time could be needed, depending on the pool size. The cleaner was not designed to automatically clean steps or swimouts or to work under a solar cover. It was also not designed to do initial cleanup for a new pool or when opening your pool for the season.

AFTER installing the cleaner, make sure the cleaner is operating correctly :

The cleaner may need some minor adjustments to make sure it is operating properly so there is no damage to the pool finish. Certain vinyl liner patterns are particularly susceptible to surface wear, pattern removal, ink rubbing off of, or serious scratches to the pattern caused by objects coming into contact with the vinyl surface, including automatic pool cleaners. Pentair Aquatic Systems is not responsible for any pattern removal, abrasions or markings on vinyl liners.

Warnings and safety instructions for Pentair Aquatic Systems pumps and other related products are available at:
<http://www.pentairpool.com/pool-owner/safety-warnings/> or call (800) 831-7133 for additional free copies of these instructions.
 Please refer to <http://www.pentairpool.com/pool-owner/safetywarnings/> for warning and safety instructions related to this product.

WARRANTY INFORMATION

Limited Warranty Terms & Conditions

Before installing your cleaner, review and understand all warnings, safety and warranty information in this guide. Failure to follow these instructions or improper installation of the cleaner can result in damage to the pool finish or the vinyl liner, Pentair Aquatic Systems disclaims any liability for repairs or replacement to any of these structures or components of the customer's pool.

The Cleaner manufacturer, Pentair Aquatic Systems ("Manufacturer"), hereby provides the following limited warranty to the purchaser ("Customer"): WHICH IS SUBJECT ONLY TO THE FOLLOWING CONDITIONS AND EXCLUSIONS:

This limited warranty does not include replacement of parts which become discolored due to exposure to sunlight or chemicals, or parts which, even if worn, do not affect performance of the cleaner. Nicks, scratches, fading, discoloration, etc. are cosmetic conditions that do not affect mechanical performance. **Both Manufacturer and dealer of Pentair Aquatic Systems reserve the right to deny any and all warranty claims made for worn parts if the wear does not negatively affect mechanical performance of the cleaner.**

The Cleaner is designed to function in a properly designed, constructed and maintained pool. This limited warranty does not extend in the circumstances where the pool's design, construction or maintenance is defective, substandard or inappropriate for the Cleaner's operation.

Deterioration, discoloration or brittleness of any pool finish can be caused over time separately by, or in combination with, age, an imbalance in water chemistry, improper installation, and other factors. Customer hereby disclaims any and all claims, and releases Manufacturer from any and all claims for damages to any pool plaster or vinyl liner in Customer's pool by reason of the use and/or operation of the Cleaner.

Under no circumstances shall Manufacturer be liable for any loss or damage, whether direct, consequential or incidental, arising out of the use or inability to use the Cleaner or the Hose in Customer's pool.

This limited warranty does not apply to any injury, loss, damage, defect, or malfunction of the Cleaner or failure to function resulting from any failure to operate or maintain the Cleaner in accordance with the directions contained in the Installation and Operation Manual or operating instructions provided by Pentair Aquatic Systems or any injury, loss, damage, defect, or malfunction, or failure to function resulting from any accident, acts of God, alterations in the Cleaner by anyone other than Manufacturer; or misuse, unreasonable use, tampering, abuse, acts, omissions, failure or negligence by anyone other than Manufacturer including but not limited to such damages or injuries to parts resulting from improper installation, or damage to pump parts resulting from running the pump dry (e.g., interruption in or inadequate supply of water to internal pump parts due to loss of prime, or obstruction in lines or otherwise); or damage, defect or malfunction resulting from defects in, failure or malfunction of, or negligence, abuse, or misuse with respect to equipment other than the Cleaner; or any damage or loss of any nature whatsoever and personal injury caused due to the presence of a foreign object in or about the pool.

Disclaimer of Liability About your Pool and 'Lil Shark

There are a multitude of factors that contribute to the life of your pool. The 'Lil Shark™ Aboveground Pool Cleaner are very passive products that will have no impact on pool life.

Please be aware that over time, deterioration, discoloration and brittleness of any pool finish can be caused separately by, or in combination with, age, an imbalance in pool water chemistry, improper installation and other factors. Pool cleaners, such as the 'Lil Shark, will not remove or cause wear on "good" pool plaster. In fact, the opposite is true—pool plaster will eventually cause wear on the cleaner.

The same situation holds true for vinyl-lined in-ground swimming pools, because vinyl liners are also affected by the environment and factors such as pool water chemistry, sunlight and the pool's surroundings. Therefore over time, vinyl can become brittle and weak. In addition, vinyl-lined pools are affected by the workmanship, composition and installation of the liner and the workmanship and quality of construction of the supporting walls and pool base. These are all factors which can contribute to liner failure. The existence of any of these type of conditions in your pool is not caused by the use or operation of the 'Lil Shark. The manufacturer disclaims any liability for repairs or replacement to any of these structures or components of the customer's pool.

The pool owner must assume all responsibility for the condition and maintenance of the pool's surface, water and deck.

SAVE THESE INSTRUCTIONS

PREPARATION OF THE POOL

STEP 1:

Preparation of the Pool

- A. Before operation of cleaner, make the following preparations before proceeding:
1. Chemically balance the pool water.
 2. Brush pool and let the debris settle.
 3. Hand vacuum thoroughly.
 4. Clean filter and pump strainer basket.
- B. Start Pump.

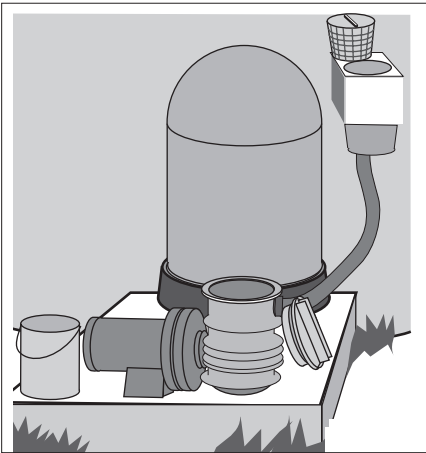

STEP 3:

Assemble Cleaner

- A. Attach hose sections as shown in Fig. 1.
- B. Insert swivel assembly into top of cleaner body and twist 1/4 turn clockwise to lock. See Fig. 2.
- C. Attach hose assembly to cleaner swivel assembly.

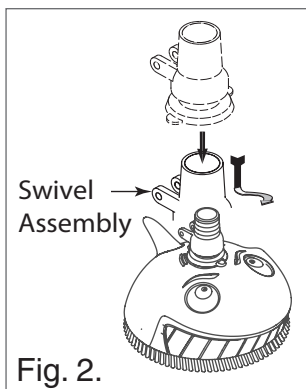
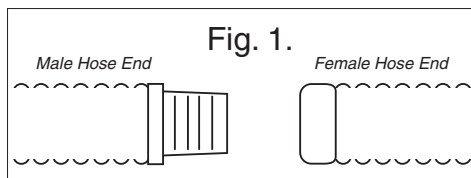

STEP 2:

Check Parts

- A. Make sure you have all parts to pool cleaner.

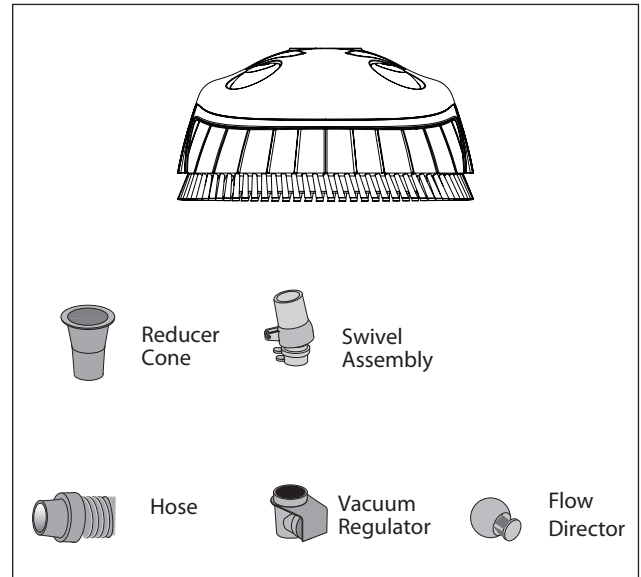

STEP 4:

Submerge Cleaner

- A. Turn cleaner upside down, submerge, and feed cleaner and hose down side of the pool wall to fill hose with water. Fig. 3.

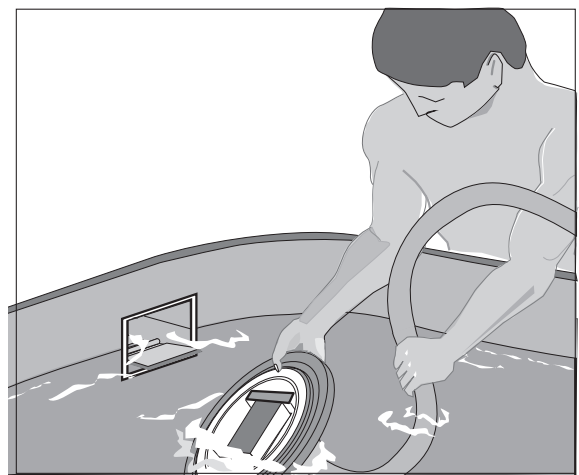
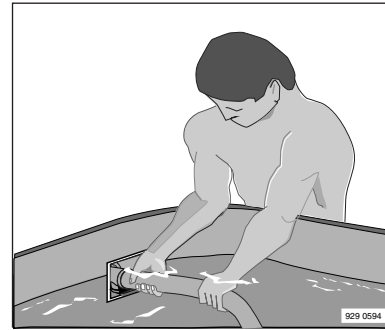

Fig. 3.

STEP 5:**Connect Hose To Skimmer**

With filter system running, connect hose to skimmer or to suction port. See below for hose connections.

**Hose Connections**

Follow drawing that most closely resembles your skimmer installation. Fig. 4.

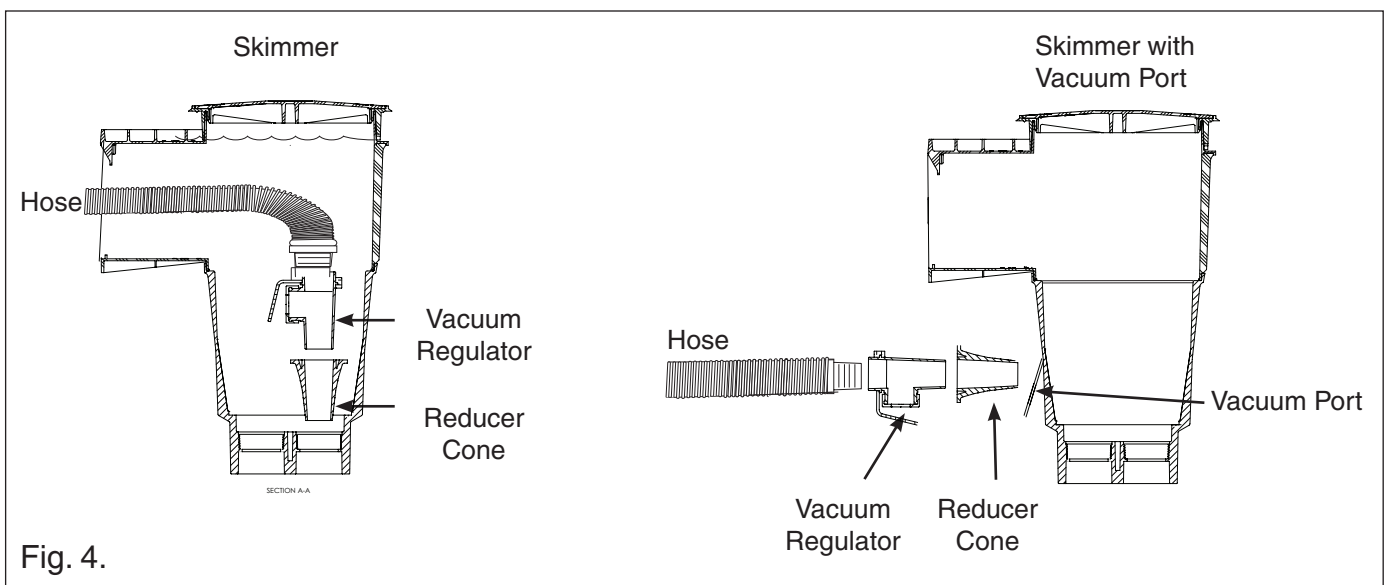
**Automatic Vacuum Regulator**

WARNING Hazardous suction. Can trap or tear hair or body parts. Install vacuum regulator on all installations.

- Every system requires a vacuum regulator for safe operation.
- Regulator provides vacuum relief in case cleaner suction is blocked.
- Black rubber diaphragm must always be submerged. If it sucks air, the pump will lose prime, which could damage the pump

STEP 6:**Size The Hose**

For best results:

With the cleaner running and submerged, pull hose to furthest end of the pool. The hose should extend to the furthest point in the pool, plus one section.

Add or remove hose sections as needed.

Note: The hose is designed for use with the cleaner. Use of a different type of hose will reduce the cleaner's performance.

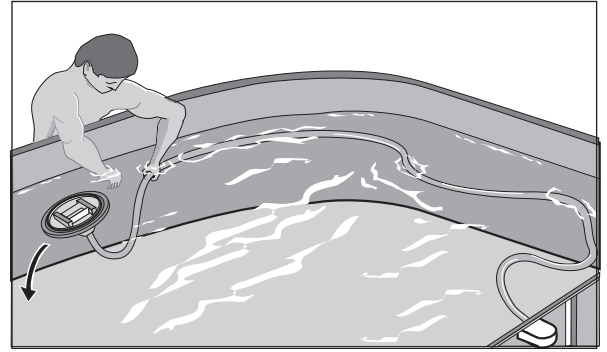
**Step 7:****Pool Coverage**

Factory setting is set at #0. When watching the cleaner for the first time, adjust these settings to ensure complete cleaning coverage. See Fig. 5.

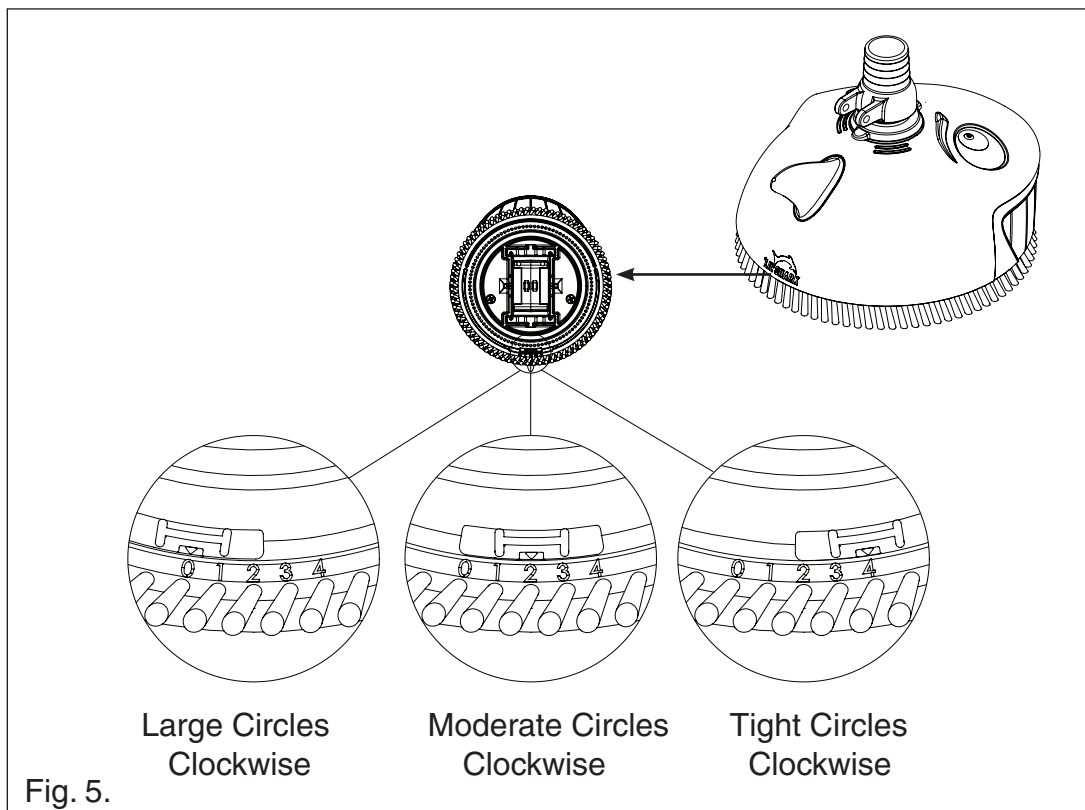
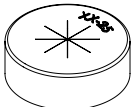

Fig. 5.

TROUBLESHOOTING

| Problem | Corrective Action |
|---|---|
| Cleaner moves slowly or not at all. | <ul style="list-style-type: none"> • Backwash and clean filter. Empty all baskets. • Clear debris from oscillator or hose. • If hoses from pool to filter and pump are less than 1-1/2" diameter, replace with 1-1/2" diameter hoses. • Pump may be too small. Consult pool professional. • If your pool has a main drain (floor drain), close it during cleaner operation. |
| Cleans only perimeter of pool. | <ul style="list-style-type: none"> • Make sure vacuum regulator is installed. • Set brush ring adjuster to a higher number. See pg. 3. |
| Cleaner hovers in one area with hose fully extended. | <ul style="list-style-type: none"> • Hose is too short. The hose should reach furthest point in pool plus one section. |
| Cleaner turns in clockwise circles only and only covers one section of pool. | <ul style="list-style-type: none"> • The cleaner is designed to move in a clockwise direction. • Set brush ring adjuster to a lower number. See pg. 3. |
| Oscillator/cleaner runs too fast. | <ul style="list-style-type: none"> • Make sure vacuum regulator is installed. (the regulator marked "50" will reduce cleaner speed). • If your system has a return valve, gradually close it until oscillator runs at the desired speed. |
| Hose keeps coiling up. | <ul style="list-style-type: none"> • For best results, when hose is not in use, store it flat and straight and out of sun. • Hose is too long; remove sections as needed. See pg. 3 - step #6. |
| Pool not completely clean in four hours. | <ul style="list-style-type: none"> • Any cleaner may miss spots. Spot clean pool by attaching a vac-pole (telepole) to cleaner and steering it (see Page 5). • Try different brush ring adjuster settings (0-4) until the cleaner gives the desired results. • The cleaner was not designed to work under all solar covers. • Strong winds may interfere with complete cleaner coverage due to hose movement. |
| Cleaner flips on its side when pump stops. | <ul style="list-style-type: none"> • This is normal if filter system develops a backpressure surge when the pump stops. The cleaner will right itself when system is restarted. |
| Hose comes loose when pump stops. | <ul style="list-style-type: none"> • Use reducer cone in skimmer. • Ensure all connections are tight. |
| Cleaner sticks to pool bottom or pool main drain. | <ul style="list-style-type: none"> • Install diaphragm marked "50" in vacuum regulator. • Check inner brush ring for excessive wear.  |

REPLACEMENT PARTS

'Lil Shark™ Aboveground Pool Cleaner Illustrated Parts List

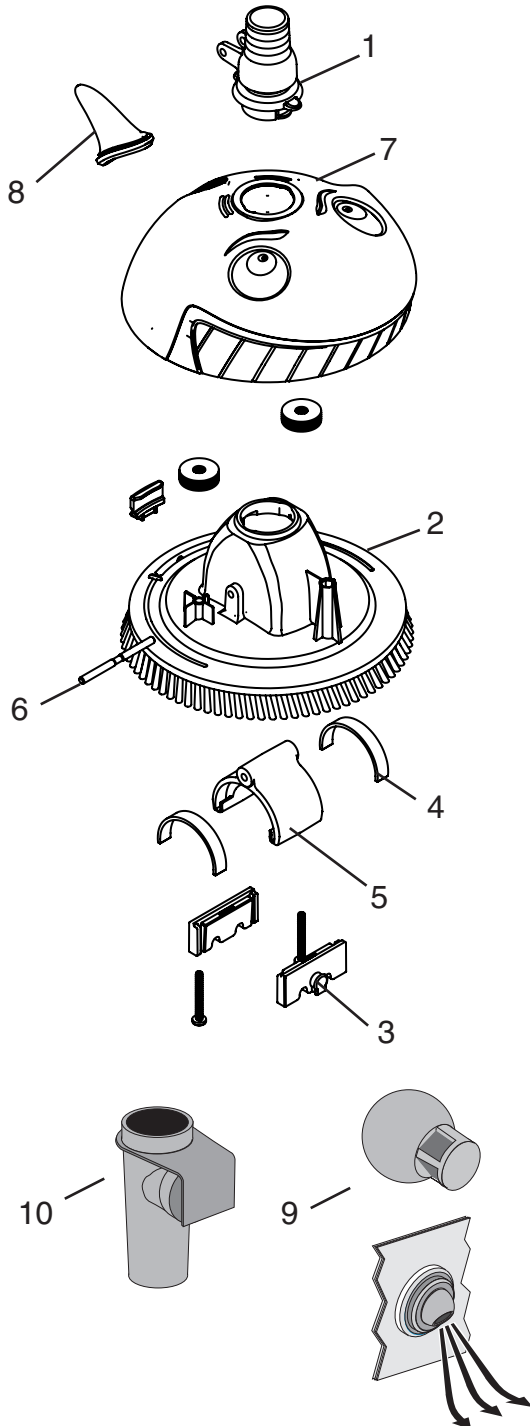

| Item No. | Part No. | Part Description |
|----------|------------|-------------------------------------|
| 1 | GW9012 | Swivel Assembly |
| 2 | * | Pool Cleaner Body (with Bristles) |
| 3 | 41100-0027 | Oscillator Impact Bumper (Pkg of 2) |
| 4 | GW9004 | Oscillator Seals (Pkg of 2) |
| 5 | GW9003 | Oscillator Kit (Includes Seals) |
| 6 | GW9002 | Axle Shaft |
| 7 | 371514Z | Cover Kit |
| 8 | 371508Z | Fin Kit |
| 9 | GW9014 | Flow Director |
| - | 371526Z | Replacement Hose Kit |
| 10 | GW9018 | Vacuum Regulator |
| 11 | GW9015 | Reducer Cone |
| 12 | GW9019 | Unidapt Handle |

- Not Shown

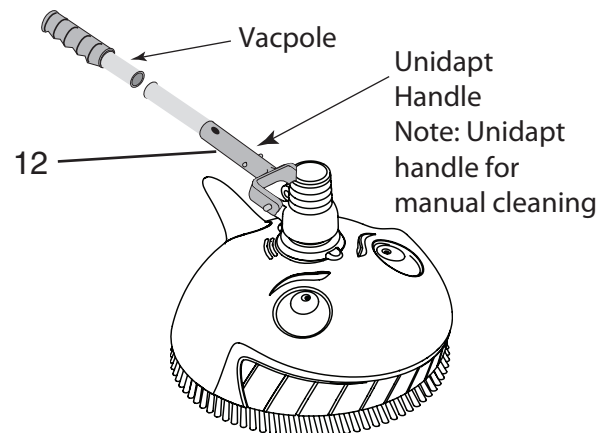

Oscillator Removal

To remove Oscillator from cleaner, remove cover/skin by removing 2 screws on bottom of cleaner with phillips head screwdriver. Tip cleaner on to its side, support side of housing, and tap axle shaft out of body. Oscillator will now slide out of cleaner body. Oscillator impact bumpers can be pried out of slots in cleaner body (they slide towards bottom of cleaner). To replace, reverse procedure.

NOTES

SAVE THESE INSTRUCTIONS