

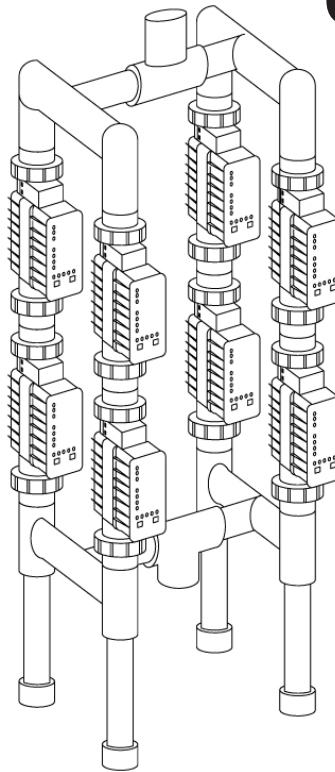

IntelliChlor® Electronic Chlorine Generator Commercial System COMSYS-16 520977

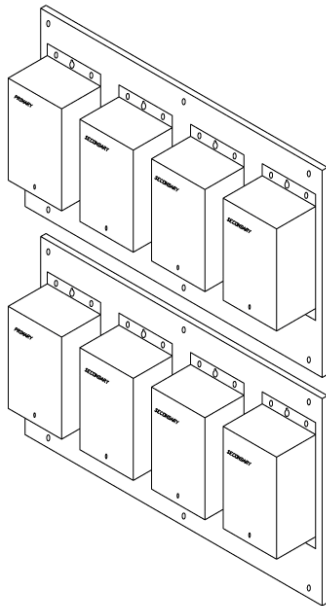

Installation Guide

 **UL** US
LISTED SWIMMING POOL
AND SPA CHLORINATOR
30ZR
Patents pending

 **NSF** Certified to NSF/ANSI 50

**IMPORTANT SAFETY INSTRUCTIONS
READ AND FOLLOW ALL INSTRUCTIONS
SAVE THESE INSTRUCTIONS**

© 2009 Pentair Water Pool and Spa, Inc. All rights reserved

This document is subject to change without notice

1620 Hawkins Ave., Sanford, NC 27330 • (800) 831-7133 • (919) 566-8000
10951 West Los Angeles Ave., Moorpark, CA 93021 • (800) 831-7133 • (805) 553-5000

IntelliChlor® and Pentair Water Commercial Pool and Spa™ are trademarks and/or registered trademarks of Pentair Water Pool and Spa, Inc. and/or its affiliated companies in the United States and/or other countries. Unless noted, names and brands of others that may be used in this document are not used to indicate an affiliation or endorsement between the proprietors of these names and brands and Pentair Water Pool and Spa, Inc. Those names and brands may be the trademarks or registered trademarks of those parties or others.

Contents

IMPORTANT SAFETY PRECAUTIONS	ii
Installation Steps Summary	iii
Technical Support	iii
IntelliChlor® Electronic Chlorine Generator COMSYS-16 Overview	1
Features	1
Preparing the Site	1
Mount Power Center Banks To Wall	2
Installation	2
Kit Contents	2
Required Tools	2
Connect AC Power Wires and ORP Sensor Wires	3
Assemble the Manifold	6
Glue the manifold	6
Connect the IntelliChlor Cells	7
Power Centers	8
Power Up the system	9
Operation	9
Troubleshooting	10

IMPORTANT SAFETY PRECAUTIONS

SAVE THESE INSTRUCTIONS



Important Notice: Attention Installer: This manual contains important information about the installation, operation and safe use of this product. This information should be given to the owner and/or operator of this equipment. When installing and using this electrical equipment, basic safety precautions should always be followed, including the following:



⚠ WARNING: IMPORTANT SAFETY INSTRUCTIONS PERTAINING TO A RISK OF FIRE, ELECTRIC SHOCK, OR INJURY TO PERSONS. READ AND FOLLOW ALL INSTRUCTIONS.

Before installing this product, read and follow all warning notices and instructions which are included. Failure to follow safety warnings and instructions can result in severe injury, death, or property damage. Call (800) 831-7133 for additional free copies of these instructions.



WARNING: To reduce the risk of injury, do not permit children to use this product.



WARNING: CHLORINE GAS BUILDUP CAN OCCUR WITH IMPROPER WIRING: To reduce the risk of personal injury the IntelliChlor® Electronic Chlorine Generator (IECG) Power Supply must be installed on and wired to the load side of the time clock, electronically controlled switch, or relay load side, so that it will receive power only when the pool pump is on. Otherwise, dangerous chlorine gas buildup can occur. The IECG should never be energized when the pool pump is OFF and water is not flowing through the unit.



WARNING: To reduce the risk of injury, service should only be performed by a qualified pool service professional.



WARNING: Never operate the IntelliChlor Electronic Chlorine Generator (IECG) without proper flow or water circulation. A build-up of flammable gases will result in hazardous conditions.



CAUTION - IntelliChlor Electronic Chlorine Generator (IECG) is for use with permanently-installed pools and may also be used with hot tubs and spas if so marked. Do not use with storable pools. A permanently-installed pool is constructed in or on the ground or in a building such that it cannot be readily disassembled for storage. A storable pool is constructed so that it is capable of being readily disassembled for storage and reassembled to its original integrity.



CAUTION - The CIC60 Power Center must be interconnected with pool pump motor power source. This ensures the IECG and pool pump will switch on and off together.







WARNING - The CIC60 Power Center is only intended for use with the CIC60 cell, DO NOT PLUG ANY OTHER INTELLICHLOR CELL INTO THIS POWER CENTER, SEVERE DAMAGE WILL RESULT.

IMPORTANT SAFETY PRECAUTIONS

SAVE THESE INSTRUCTIONS



WARNING: When mixing acid with water, **ALWAYS ADD ACID TO WATER. NEVER ADD WATER TO ACID.**

-  **CAUTION** - Use of chemicals other than those recommended may be hazardous. Even proper use of the recommended chemicals can be hazardous. Follow the Chemical Manufacturer's Instructions.
-  **CAUTION** - To reduce the risk of electric shock, install IntelliChlor Electronic Chlorine Generator (IECG) a minimum of five (5) feet away from the inside wall of the pool.
-  **CAUTION** - Install the IECG a minimum of three (3) feet away from the heater outlet.
-  **CAUTION** - It is recommended to install a Pentair two (3) inch CHECK VALVE (P/N 263060) between the input side of the IECG and the main heater output pipe.
-  **CAUTION** - A solid copper, bonding conductor not smaller than No. 8 AWG (8.4 mm) should be connected to all metal parts of the swimming pool, spa, or hot tub structure and to all electrical equipment, metal conduit, and metal piping within five (5) feet (1.5 m) of the inside walls of a swimming pool, spa, or hot tub, when the unit is installed within five (5) feet of the inside walls of the swimming pool, spa, or hot tub.

Canada - Industry Canada (IC) - This device complies with RSS210 of Industry Canada. (1999)

FCC Standard - 47 CFR Part 15, Subpart C (Section 15.247). This version is limited to chapter 1 to chapter 11 by specified firmware controlled in the U.S.A.

Federal Communications Commission (FCC) - This device complies with Part 15 of the FCC Rules. Operation is subject to the following two conditions: (1) this device may not cause interference, and (2) this device must accept any interference, including interference that may cause undesired operation of the device.

Interference Statement - This equipment has been tested and found to comply with the limits for a Class B digital device, pursuant to Part 15 of the FCC Rules. These limits are designed to provide reasonable protection against harmful interference in a residential installation. This equipment generates, uses and can radiate radio frequency energy and, if not installed and used in accordance with the instructions, may cause harmful interference to radio communications. However, there is no guarantee that interference will not occur in a particular installation. If this equipment does cause harmful interference to radio or television reception, which can be determined by turning the equipment off and on, the user is encouraged to try to correct the interference by one or more of the following measures:

- Reorient or relocate the receiving antenna.
- Increase the separation between the equipment and receiver.
- Connect the equipment into an outlet on a circuit different from that to which the receiver is connected.
- Consult the dealer or an experienced radio/TV technician for help.

Note: Modifications not expressly approved by the party responsible for FCC compliance could void the user's authority to operate the device.

Technical Support

Sanford, North Carolina (8 A.M. to 5 P.M. Eastern Time)

Moorpark, California (8 A.M. to 5 P.M. Pacific Time)

Phone: (800) 831-7133

Fax: (800) 284-4151

Web sites

visit www.pentairpool.com and www.staritepool.com

IntelliChlor® Electronic Chlorine Generator COMSYS-16 Overview

The IntelliChlor COMSYS-16 commercial system consists of eight IntelliChlor cells and eight power centers (primary and secondary).

Each cell can produce up to 2.00 lbs of pure chlorine per 24 hours of operation. These cells can sanitize either a pool or spa, or combination of both. A commercial system requires an external ORP panel and sensor to produce chlorine upon demand as needed. The ORP system is sold separately.

Features

- Each cell draws approximately 220 Watts.
- Dry contact wires on primary power center connect to chlorine controller panel (ORP system). Closing these wires sets the cells on at 100% producing chlorine. Opening these two wires sets the cells off at 0%, and no chlorine will be produced.
- Each cell produces 2.00 pounds of chlorine per 24 hours.
- Comsys-16 produces 16 pounds of chlorine per day.
- The ORP system (not provided) is a separate device that monitors the available chlorine in the water and, when needed, calls for chlorine to be produced by closing a dry contact output. An ORP system consists of a panel, usually with an LCD display, that has the ORP sensor in the water.

Preparing the Site

1. Add salt to the water until it measures 3500 ppm. Use an electronic tester to measure salt, such as the Extech EC400. **DO NOT USE SALT TEST STRIPS AS THEY TEND TO BE INACCURATE.** Allow the salt to mix for 24 hours before using the IntelliChlor system.
2. Locate a clear spot on a wall, within 15 feet of the IntelliChlor manifold.
3. Locate a clear spot on the return line where the IntelliChlor manifold will be mounted. Be sure that the user can readily see the lights and press buttons if needed.
4. Be sure 110VAC or 220VAC is available and on its own circuit breaker, to power the IntelliChlor power centers. This separate breaker will make it easier to service the IntelliChlor.
5. Be sure 110VAC or 220VAC is provided to the power center bank in a conduit, for maximum safety and NEC compliance.

Installation

Before installing the IntelliChlor CIC60 system, please read all SAFETY PRECAUTIONS below.

Kit Contents

- Eight Power Centers (one primary, seven secondary)
- One CIC60P cell
- Seven CIC60S cells
- Installation Guide (this manual)

Required Tools

- Medium phillips or flathead screwdriver (and twelve screws)
- Electric drill and 1/4" masonry drill bit. (To mount Power Center Bank)



SAFETY PRECAUTIONS - PLEASE READ BEFORE PROCEEDING

DANGER



IMPORTANT SAFETY PRECAUTIONS. PLEASE READ THE FOLLOWING:

Read all the safety precautions in this manual before attempting any electrical wiring. Be sure to read and follow all safety Instructions on page ii. Wiring should only be performed by a qualified professional. When using electrical products, basic precautions should always be followed, including the following:

WARNING

RISK OF ELECTRIC SHOCK, WHICH CAN RESULT IN SERIOUS INJURY OR DEATH. Before attempting installation of service, ensure that all power to the circuit supplying power to the system is disconnected/switched off at the circuit breaker. The Power Center must be interconnected with pool pump motor power source. This insures the IntelliChlor chlorinator and pool pump will switch on and off together.

- Grounding (earth bonding) is required. The unit should be installed by a qualified service person and grounded.

CAUTION - Install the IntelliChlor cell a minimum of two (2) feet from the heater outlet.

- Allow ample access to the IntelliChlor control panel buttons and the IntelliChlor Power Center.
- Pipe couplings: Schedule 80, maximum pressure 150 psi at 70° F.
- Operate unit with minimum flow of 25 gpm. For high flow applications, use a bypass loop.

Mount Power Center Banks To Wall

1. Locate a wall near the pool equipment area within 15 feet of the IntelliChlor cells. Position the CPC104 POWER CENTER BANK on the wall at eye level. Mount and secure each the power center banks to the wall using six (12) screws (not provided in kit). See illustration on next page.
2. Position the CPC204 POWER CENTER BANK on the wall at eye level either just below or to the right of the CPC104.
3. Mount and secure the CPC204 power center bank to the wall using six (6) screws (not provided in kit). See next page for illustration.

Mount Power Center Banks To Wall (Continued)

- Remove the cover retaining screw and remove the cover from upper side left **PRIMARY** power center and the lower left side **SECONDARY** power center.

Remove cover screw and cover from
PRIMARY POWER CENTER

Mount power center
bank to wall using six
(6) screws

Remove cover screw and cover from
SECONDARY POWER CENTER

Mount power center
bank to wall using six (6)
screws

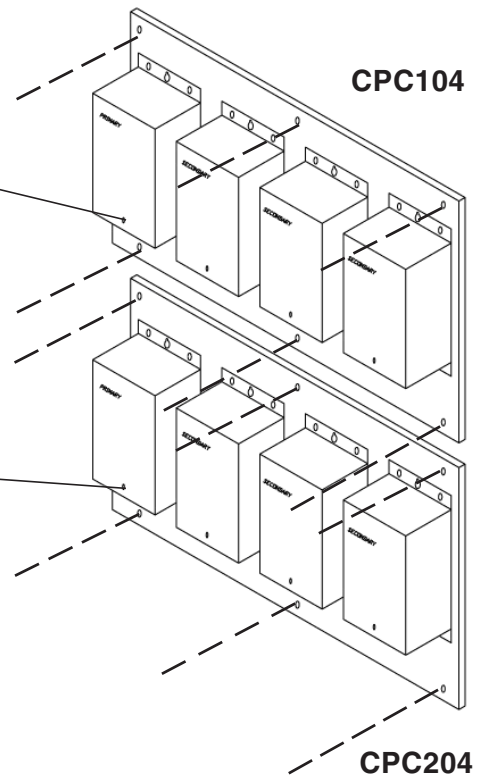

Connect AC Power Wires and ORP Sensor Wires

- Mount a JUNCTION BOX on the left side of the Power Center Banks.
- Run a CONDUIT (with 208VAC - 260VAC wires) from the AC BREAKER to the junction box. Note: This AC power should be on its own breaker for future servicing.

Note: For 110VAC operations, each power center will need to be re-configured. A 110VAC wiring diagram is provided on the inside of each the power center covers.

- Run conduit from the junction box into each of the power centers located on the left side (PRIMARY and SECONDARY). A (knock-out) conduit opening is provided on the bottom of each of power centers.

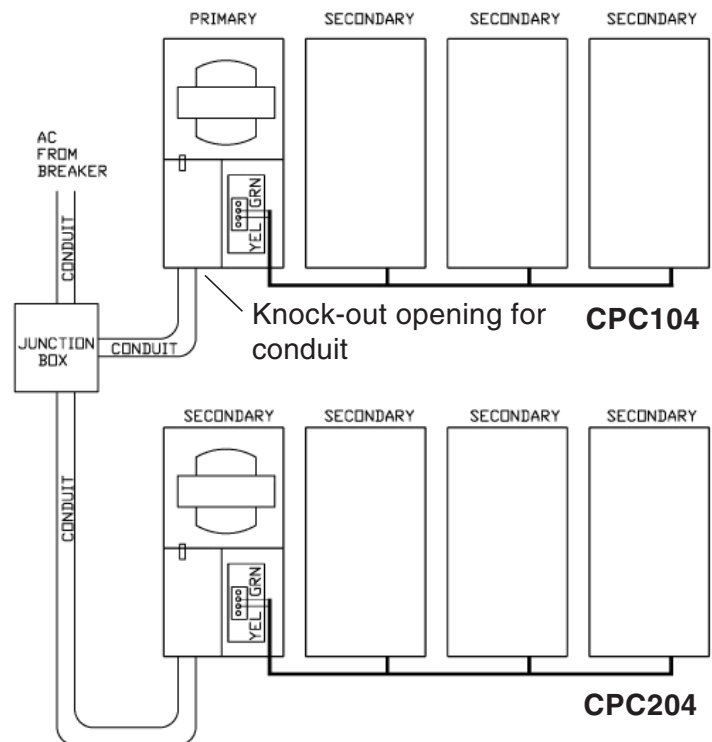

Connect AC Power Wires and ORP Sensor Wires (Continued)

4. Splice the incoming AC power wires onto the two wires labeled **WIRED FOR 220V**. Do not apply AC power yet.
5. Connect the two (2) twisted wires labeled **ORP SENSOR** to the ORP chlorine controller panel (AcuTrol, etc). Carefully place the connection inside of power center.
6. Replace the cover on the upper Primary power center and lower Secondary power center. Secure each cover with the retaining screw.

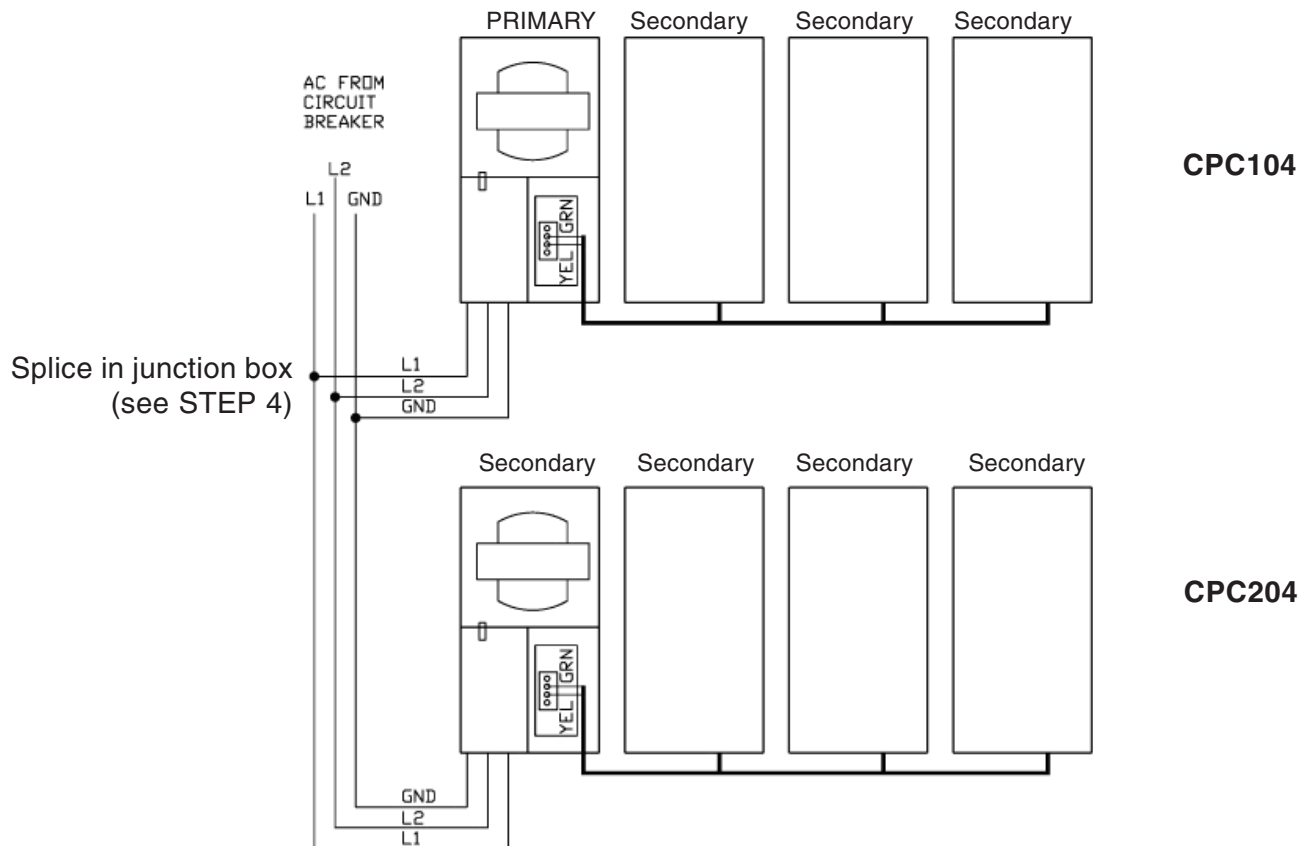
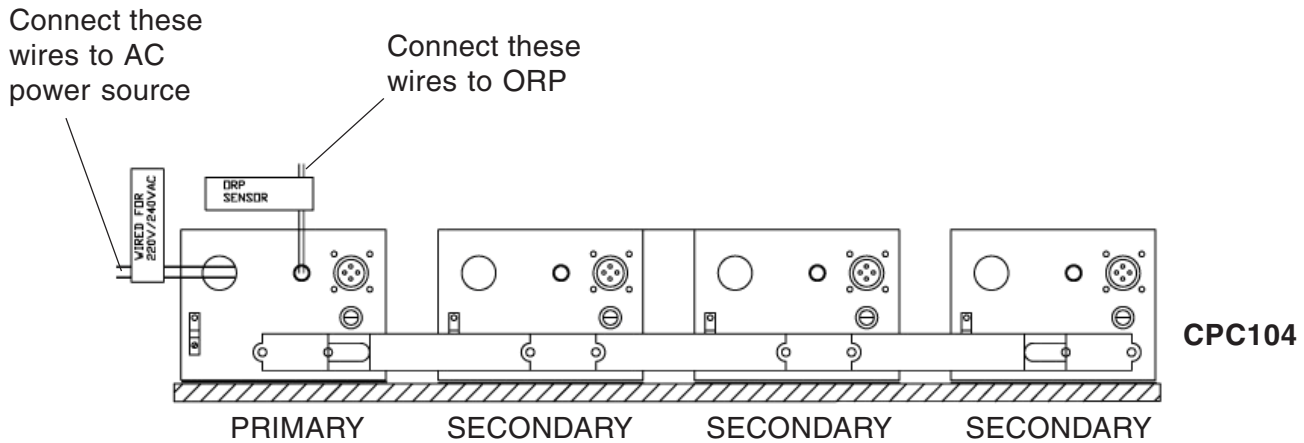

7. Remove the cover retaining screw and remove the cover from the **SECONDARY** power center, located on the top bank, far right side.
8. Route the communication cable from the CPC204 power center through the bottom hole of the CPC104 Secondary power center.
9. Insert the two wires from the CPC204 into terminal block in same order as the wires already connected. Be sure to match the wire colors. GREEN to GREEN and YELLOW to YELLOW.
10. Replace the cover on the upper Secondary power center (top far right side). Secure the cover with the retaining screw.

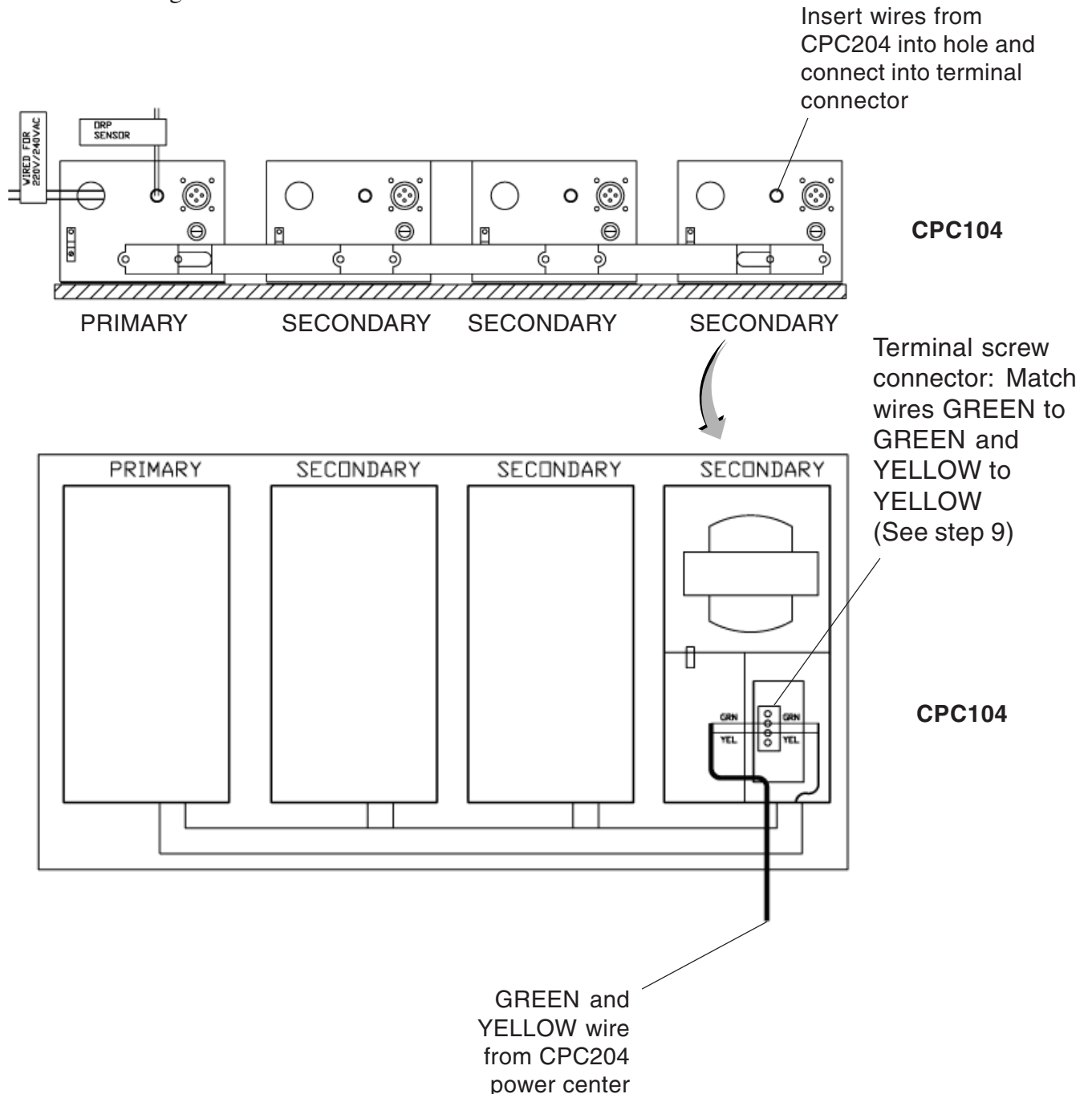

Assemble the Manifold

1. Place an o-ring into groove on union coupling (two per cell).
2. Place each cell on the manifold and tighten coupling nut securely. Be sure the o-ring stays in place.
Note: Cells labeled PRIMARY and SECONDARY can be placed anywhere in the manifold, they do not need to be in a specific location.
3. Glue the manifold into the system plumbing at desired location, either horizontal or vertical. Make sure the cells are readable and the buttons can be pressed if needed.
CAUTION: Do not install upside down!
4. Verify water flow direction See the FLOW arrow located on the IntelliChlor cell near the input coupling.

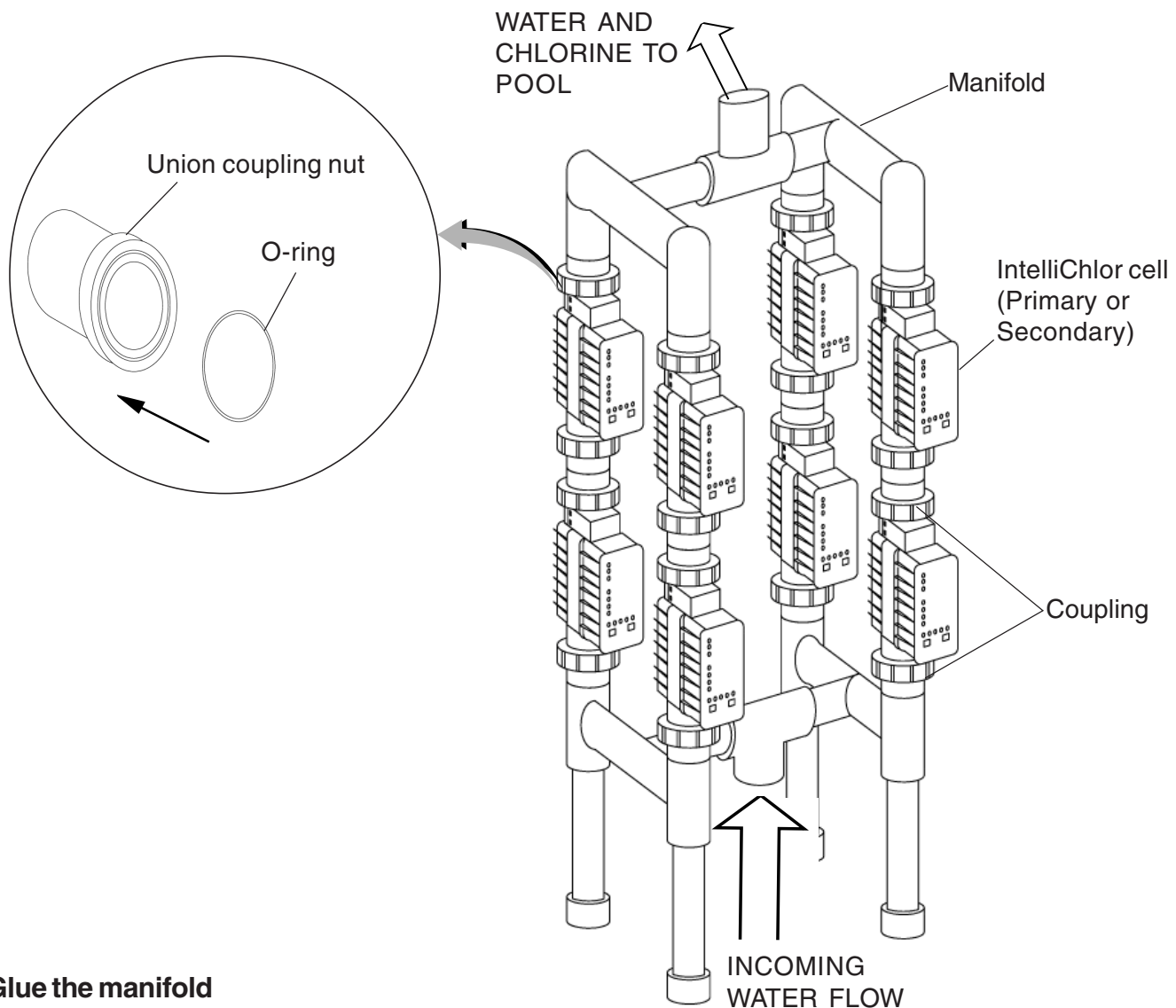

Glue the manifold

6. Glue manifold into system plumbing at the desired location. The manifold will sit on the floor. Be sure the cells are readable and the buttons can be pressed if needed. Do not install upside down!
7. Verify water flow direction.

Connect the IntelliChlor Cells

1. Connect the cell power connector, labeled **PRIMARY (CIC60P)**, into the receptacle on the bottom of the power center labeled **PRIMARY**. While holding the connector on the receptacle, turn it slowly until the plug pins are inserted into the receptacle, then twist the to lock in place.
2. Plug the two **SECONDARY** cell power connectors into each of the power centers labeled **SECONDARY** using same method as described in step 1.

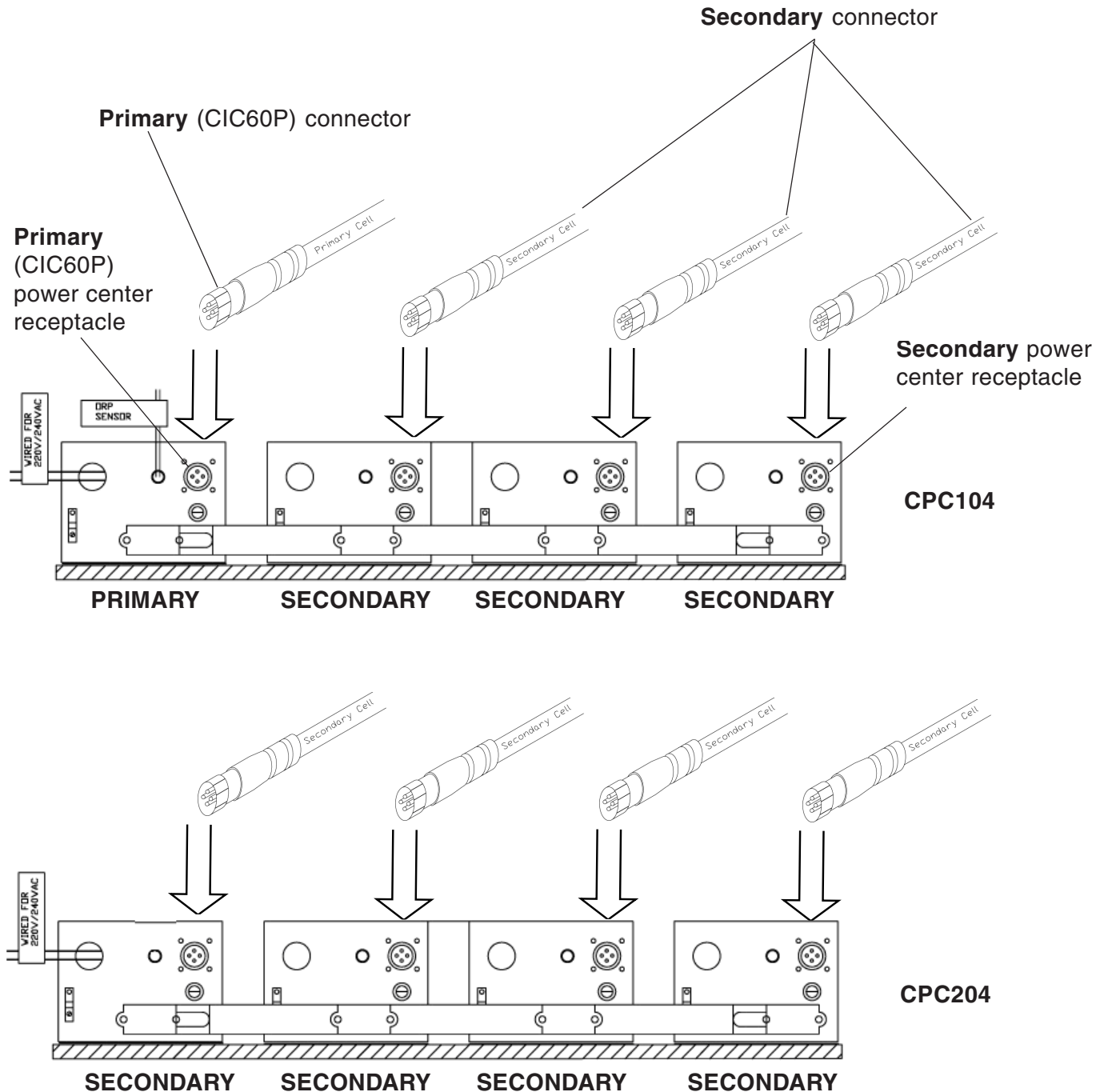

Power Centers

The **PRIMARY** and **SECONDARY** power centers are pre-wired as shown below.

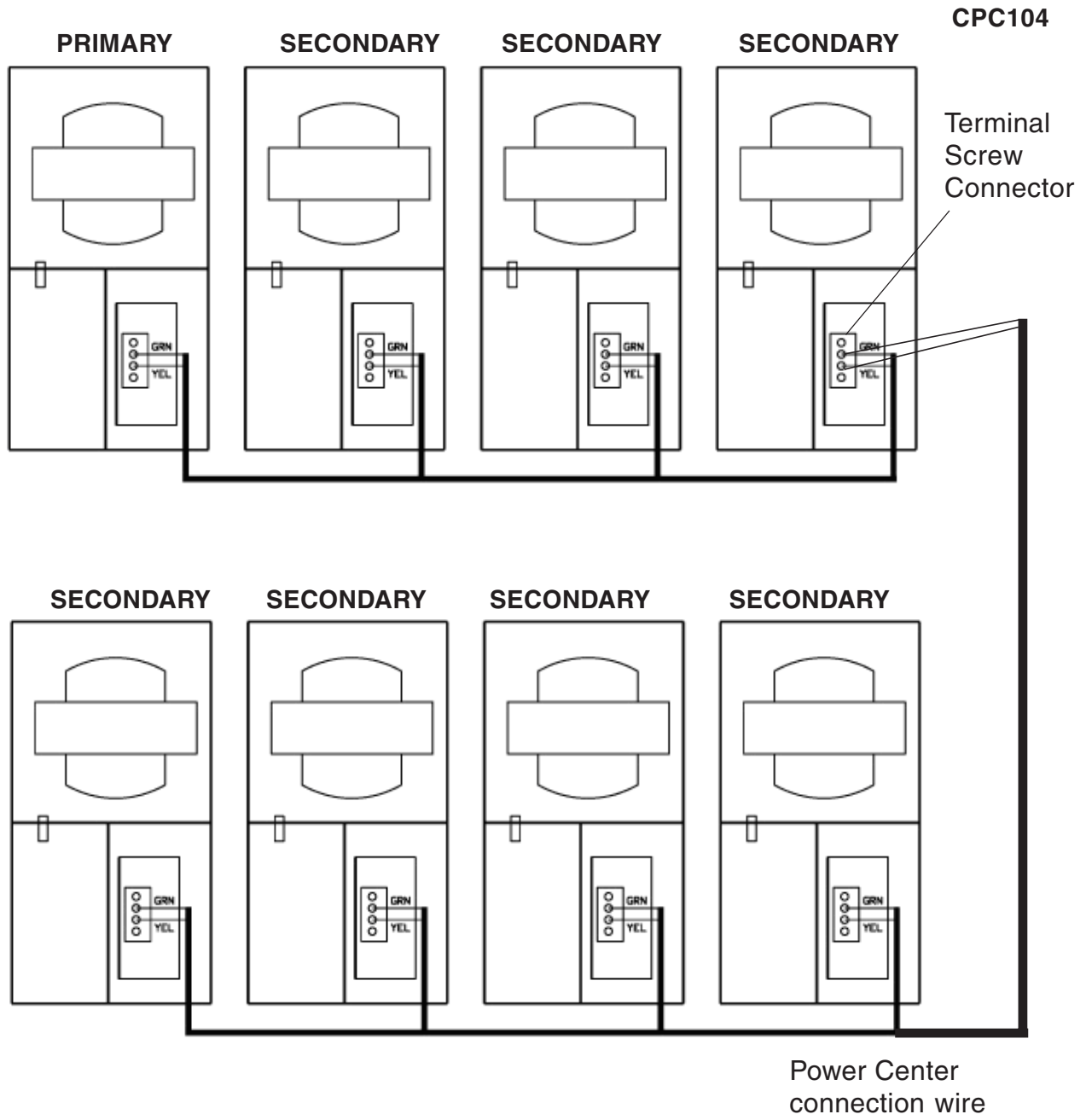

Power Centers (Front View)

CPC204

Power Up the system

1. Switch the AC circuit breaker to ON to apply AC power to the system.
2. After the system is powered up for one minute, if any SECONDARY cell shows a red PWR light, the communications to that cell is not connected.

Open the power center covers and verify the two green and yellow wires on each terminal block are connected and in the same order. Verify these connections from each SECONDARY power center to the PRIMARY power center (see page 8).

3. Apply water flow to the cell manifold. When water flow is present, each cell's FLOW light will go from red (no flow) to green (flow).
4. The GOOD, CHECK SALT and LOW salt lights on each cell will scroll back and forth for two minutes before checking the salt level. If water flow is not present, then restored, this two minutes will start over. Note: THE SALT LEVEL CAN NOT BE CHECKED WHEN THE FLOW LIGHT IS RED.
5. After two minutes, the salt level will be read and displayed on all cells.

Operation

When the ORP system requests chlorine, it closes the dry-contact output that is connected to the ORP SENSOR wires, and causes each cell to light their 100% light. The CELL light will turn on and chlorine will be produced. If the ORP system is not requesting chlorine (ORP SENSOR wires open), all lights in the SANITIZER OUTPUT section will be off, no chlorine is produced.

Chlorine will be produced only when:

- SANITIZER OUTPUT 100% light is on
- CELL is green and not flashing
- FLOW light is green
- Salt is FLASHING GOOD, GOOD, or CHECK SALT
- PWR light is green

Note: Verify each cell has a green FLOW light, to show that adequate water is flowing through the cell.

- After power up, all cells will scroll the salt lights LOW, CHECK SALT and GOOD for 2 minutes while waiting to check salt. If FLOW is red, these lights will scroll indefinitely.
- After 2 minutes of green FLOW, the salt will be read and all cells will now display the same salt color.
- The cells will produce chlorine whenever the ORP controller calls for chlorine.
- Set the ORP controller to the desired chlorine levels and cutoff (not part of the IntelliChlor system).
- If the CELL light is flashing, the cell has become dirty and requires acid cleaning. Turn off the circuit breaker to the power centers, disable water flow through the manifold (either an external valve or turn off the filter pump), and remove the cell. Check the cell and acid clean if necessary.

Troubleshooting

The IntelliChlor 100% light does not come on when the chlorine controller calls for chlorine

1. Verify the ORP controller is opening and closing the dry-contact output.
2. Remove the ORP SENSOR wires connection from the PRIMARY power center and the ORP controller. Manually tie the ORP SENSOR wires together. This will turn on the cells at 100%. If the 100% lights do not come on for each cell or only one cell, verify the communication wires are connected, shown in POWER UP THE SYSTEM, step 3, page 7.
3. If the PWR light is red, the communications are lost, refer to section 5 POWER UP THE SYSTEM, step 3. If the cable connection is good, replace the master board in the PRIMARY power center.

The IntelliChlor 100% light stays on after the chlorine controller says to stop

1. Verify the communication wires are connected, as shown in section 5, POWER UP THE SYSTEM, step 3.
2. Verify the ORP SENSOR wires are not shorted together in the power center.
3. Verify the ORP controller dry contact output is opening and closing by using an ohmmeter. Manually set this output open and closed using the controller menu system.

The CHECK SALT light is on

More salt needs to be added to the water.

1. Add salt to the water and bring up to 3500ppm. Allow it to mix for 24 hours.
2. The salt level will be automatically checked every 8 hours by the cells and displayed.

The LOW salt light is on

Not enough salt is in the water to produce chlorine, cell is OFF.

1. Add salt to the water and bring up to 3500ppm. Allow it to mix for 24 hours.
2. The salt level will be checked every 8 hours by the cells and displayed.

Not enough chlorine is produced

1. Ensure the ORP sensor probe on the chlorine controller unit is clean and working.
2. Verify the IntelliChlor cells do not have a flashing CELL light. If so, remove the cell and acid clean.
3. Verify no debris is in the cells. Remove if present.
4. Verify the FLOW light is green, for adequate water flow.
5. Verify the salt level lights are displaying either green GOOD or yellow CHECK SALT. If displaying yellow CHECK SALT, add salt to the water, and allow to mix for 24 hours.
6. Verify the ORP controller sets the cells to 100% SANITIZER OUTPUT or 0%, by manually controlling this output relay (done in the ORP controller, not the IntelliChlor) or by disconnecting the ORP SENSOR wires from the power center and manually opening and closing the wires.
7. Verify the ORP probe is clean.
8. Verify the filter pump is not being turned off by a timer.

The PWR light is red.

1. Communication has been lost between the power centers and cells. Verify the communication connection. See “POWER UP THE SYSTEM” step 3, page 7.
2. If the communications are connected, replace the master board in the PRIMARY power center.

The cell is not powered up

1. Check fuse, replace if open.
2. Check if cell connector is plugged and twist-locked all the way in.

Fuse is blown

1. Replace with 12 amp ceramic fuse. DO NOT USE 10AMP glass (a common fuse), it is not reliable and might fail later. If the fuse blows again, replace the cell.
2. Verify the Power center is not wired for 110VAC and has 220VAC applied to it. THIS IS NOT COVERED BY THE WARRANTY.

Blank Page

LIMITED WARRANTY

Pentair Water Pool and Spa, Inc. ("Pentair Water") warrants the IntelliChlor® Electronic Chlorine Generator (IECG) as follows:

IECG Limited Warranty: Pentair Water warrants the IECG to be free from defects in material and/or workmanship for a period of one (1) year (parts only) from the original date of installation.

IECG Power Center Limited Warranty: Pentair Water warrants the IECG Power Center to be free from defects in material and/or workmanship for a period of one (1) (parts only) from the original date of installation.

Exceptions that shall result in Pentair's denial of a warranty claim:

1. Damage caused by careless handling, improper repackaging, or shipping.
2. Damage due to misapplication, misuse, abuse or failure to operate equipment as specified in the IECG Installation and User's Guide.
3. Damage caused by failure to install products as specified in the IECG Installation and User's Guide.
4. Damage due to unauthorized product modifications or alterations, or failure to use Pentair Water original replacement parts.
5. Damage caused by negligence, or failure to properly maintain products as specified in the IECG Installation and User's Guide.
6. Damage caused by failure to maintain water chemistry in conformity with the standards set forth in the IECG Installation and User's Guide.
7. Damage caused by water scaling, freezing or any conditions causing inadequate water circulation.
8. Accidental damage, fire, acts of God, or other circumstances outside the control of Pentair Water.
 - This warranty extends to the original retail owner (Customer) only, beginning on the date of installation and is not enforceable by any other party. Proof of purchase and/or date of installation will be required for all warranty claims. Customer agrees to pay all shipping charges to Pentair Water.
 - Warranties by others: Some products incorporate components manufactured by other manufacturers. Some of these provide warranties in addition to the warranty provided herein. In all such cases a copy of that warranty will be provided with the product. To the extent protection provided under any such third party warranty exceeds the Limited Warranty provided herein, the Customer must look only to that other manufacturer for the additional warranty protection.

Warranty Obligations of Pentair Water: Should a defect in workmanship and/or material in any item covered by this warranty become evident during the term of the warranty, then upon the Customer following the procedures set forth below, Pentair Water will, at its option, repair or replace such item or part at its own cost and expense. Pentair Water's maximum obligation under this warranty is limited to the repair and replacement of the IECG. Pentair Water disclaims all other expressed or implied warranty obligations.

Pentair Water is not, however, responsible under this warranty for any cost of shipping or transportation of the equipment or parts thereof to or from Pentair Water's Technical Service Department. Also, Pentair Water is not liable for any loss of time, inconvenience, incidental expenses such as telephone calls, labor or material charges incurred in connection with the removal or replacement of the equipment, or any other incidental or consequential damages, including but not limited to damage to pool equipment or any surface in or around the pool in which the IECG is installed.

PLEASE NOTE: Some states do not allow the exclusion or limitation of incidental, or consequential damages, so the above limitation or exclusion may not apply to you.

No Other Warranties: TO THE MAXIMUM EXTENT PERMITTED BY APPLICABLE LAW, PENTAIR WATER DISCLAIMS ALL OTHER WARRANTIES, WHETHER EXPRESS OR IMPLIED, INCLUDING, BUT NOT LIMITED TO THE IMPLIED WARRANTIES OF MERCHANTABILITY AND FITNESS FOR A PARTICULAR PURPOSE.

Continued on back page.

LIMITED WARRANTY (Continued)

Procedure for Obtaining Performance: In order to obtain the benefits of this warranty, the Customer who made the original retail purchase must contact the Pentair Water Technical Service Department upon discovery of the defect, but in no event later than the expiration date of the warranty period provided in this warranty. Upon receipt of this communication, Pentair Water will promptly notify the Customer of the address to which the defective item may be shipped. The Customer shall then ship the item, freight prepaid, to the address indicated, together with a "RETURN GOODS AUTHORIZATION" form obtained from Pentair Water's Technical Service and a brief description of the problems encountered. Unauthorized returns will not be accepted. Freight must be prepaid by customer.

Warranties or Representations by Others: No dealer or other third party entity has any authority to make any warranties or representations concerning Pentair Water or its products. Accordingly, Pentair Water is not responsible for any such warranties or representations.

Other Rights: This warranty gives you specific legal rights and you may also have other rights, which vary from state to state. This warranty supersedes all previous publications.

PENTAIR WATER POOL AND SPA, INC.

1620 Hawkins Ave. Sanford, NC 27330 - 10951 W. Los Angeles Ave. Moorpark, CA 93021 - Phone 800-831-7133 - Fax 800-284-4151

 **WARNING:** Salt is an inherently corrosive material. While the levels of salt required for proper operation of the IntelliChlor Electronic Chlorine Generator are relatively low when compared to sea water and other salt solutions, placing any amount of salt in your pool increases the likelihood of corrosion or other deterioration of pool equipment and any surfaces used in and around your pool. Metal parts and certain natural and man-made surfaces are particularly susceptible to corrosion and deterioration when used in and around salt water pools. Pentair Water Pool and Spa does not represent or otherwise guarantee that the proper use of the IntelliChlor Electronic Chlorine Generator will prevent corrosion or other deterioration of pool equipment and any surfaces used in and around your pool. Consult your experienced pool professional, who should be able to advise you on the proper material selection, installation techniques for those materials, and the proper use, care and maintenance of those materials for your specific pool type and location in order to minimize the corrosion and deterioration that is inherent in and around salt water pools.

