

Safe Installation Procedures and Care Manual Meyco Safety Pool Covers



Everyone Trusts the Original.™

Meyco Products relies on the experience and knowledge of pool professionals to properly install our products. Damage that occurs to covers that are not installed properly or maintained properly per the guidelines in this document will not be covered by Meyco's warranty.

Pool Owner	Order #
Pool Dealer	Pool Size
Cover Size	Overlap
Anchors	Date Installed

Failure to follow instructions and safety precautions in this manual can result in serious injury or death. Keep this manual in a safe location for future reference.



WARNING

AVOID DROWNING RISK

FAILURE TO FOLLOW ALL INSTRUCTIONS MAY RESULT IN DROWNING OR INJURY

DO NOT WALK ON COVER EXCEPT IN AN EMERGENCY

ENTRAPMENT POSSIBLE - REMOVE COVER COMPLETELY BEFORE ENTRY OF BATHERS

KEEP COVER DRUM TIGHT TO AVOID UNSAFE STANDING WATER

KEEP CHILDREN AWAY. CHILD CAN DROWN ON TOP OF COVER. CHILDREN OR OBJECTS CANNOT BE SEEN UNDERCOVER

NON-SECURED OR IMPROPERLY SECURED COVER IS A HAZARD

INSPECT COVER PERIODICALLY FOR WEAR

REMOVE STANDING WATER

THIS MEYCO SAFETY COVER MEETS ASTM F 1346-91 FOR MANUAL SAFETY COVERS (MSC) WHEN USED IN ACCORDANCE WITH PRINTED INSTRUCTIONS.



MEYCO PRODUCTS, INC.
1225 WALT WHITMAN ROAD
MELVILLE, NY 11747

Illustration above is a sample of the warning label attached to each pool cover.

POOL COVER SAFETY

Failure to follow safety precautions in this section could result in serious injury or death.

Avoid drowning risk:

- Do not walk on cover except in an emergency
- Entrapment possible- remove cover completely before entry of bathers
- Keep cover drum tight to avoid unsafe standing water
- Keep children away. Child can drown on top of cover. Children or objects cannot be seen under cover.
- Non-secured or improperly secured cover is a hazard.
- Inspect cover periodically for wear
- Remove standing water



This Meyco safety cover meets ASTM F 1346-91 for manual safety covers (MSC) when used in accordance with printed instructions.

REMINDER

This cover has been carefully inspected prior to shipping and determined to be free of manufacturing or material defects.

RECOMMENDED PROCEDURES for your Meyco Pool Cover

DO NOT DRAG COVER OVER ANY ABRASIVE SURFACE; CARRY COVER TO POOL AREA.

Dragging cover over concrete, brick or other abrasive surfaces will cause damage not covered by our warranty.

BE CAREFUL NOT TO CATCH THE COVER MATERIAL ON THE SPRINGS OR ANCHOR NECKS.

This could cause small pulls and tears in the material that are not covered by the warranty.

CHECK POOL WATER LEVEL; IT MUST BE WITHIN 18" OF THE TOP OF THE POOL AND MUST NOT FALL LOWER DURING THE WINTER (SNOW) SEASON.

Low water level will cause undue stress on the cover and could result in damage not covered by our warranty.

PERSONALLY HAND THE WARRANTY CARD AND CARE OF MEYCO COVER INSTRUCTIONS TO THE CUSTOMER.

Prompt return of the warranty card will enable Meyco to maintain current records



IMPORTANT

Meyco Swimming Pool Safety Covers and rough or sharp coping & edges

MEYCO Swimming Pool Safety Covers are designed with anti-abrasion strips for added protection at typical wear points where webbing straps ride over the smooth coping edge.

However, extra precaution must be taken by the installer or pool owner in areas with rough coping or sharp corners. It is recommended that additional padding (vinyl, rubber sheeting or carpet remnants) be used to prevent excessive wear.

MEYCO PRODUCTS is not responsible for damage caused by rough coping or sharp edges.

REQUIRED TOOLS & HARDWARE

Rotary hammer drill

this may be purchased from many hardware stores or rented from a tool rental shop. Common manufacturers are Bosch, Skil, Hilti, and Black & Decker.

3/4" drill bit

carbide tipped bits are normally used. Diamond tipped bits are available for longer life and more precisely round holes. If installing pipe anchors, a 15/16" or 1" drill bit will also be required.

Hammer or mallet

Tape measure

Chalk

Chalk line - to help line up anchor locations

Lubricant - a light oil or silicone spray

Buckets

PLEASE NOTE:

Hardware type and quantities shipped with your cover may be adjusted to fit your particular pool and decking requirements.

Installation into decking other than normal concrete decking may require optional or additional hardware and installation tools.

When installing a Solid Cover that requires a pump for water removal, place pump in the middle of the cover. An additional pump may be required depending on the size and shape of the pool.

REQUIRED EQUIPMENT

Hardware packed with your cover

BRASS ANCHORS TYPES - one for each cover strap

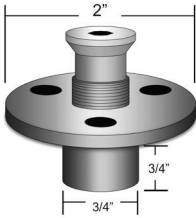

Wood Deck Anchor

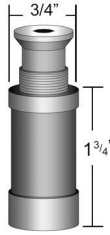

Screw Type Anchor

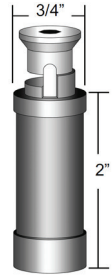

Optional Pop-up Anchor

STAINLESS STEEL COMPRESSION SPRINGS

one for each cover strap



ANCHOR TAMPING TOOL used to tamp anchors into deck



INSTALLATION ROD - for attaching and removing cover



HEX KEY - to rotate anchor insert to up or down position



For limited decking:

O-RING



SHORT SPRING



POSITIONING COVER

Remove all ladders and rails not permanently anchored into the decking. Unroll the cover off the side of the pool (if decking permits). **Do not drag or snag cover on any obstructions or the decking.** Be sure that the reinforcing strips sewn under each strap around the cover perimeter are facing down towards the pool or coping edge.

The Meyco Safety label should be facing up. Carefully rotate the cover, if necessary, to properly position the cover over the pool. If there are any cutouts for obstructions on the cover, these areas of the cover must be positioned and installed first.

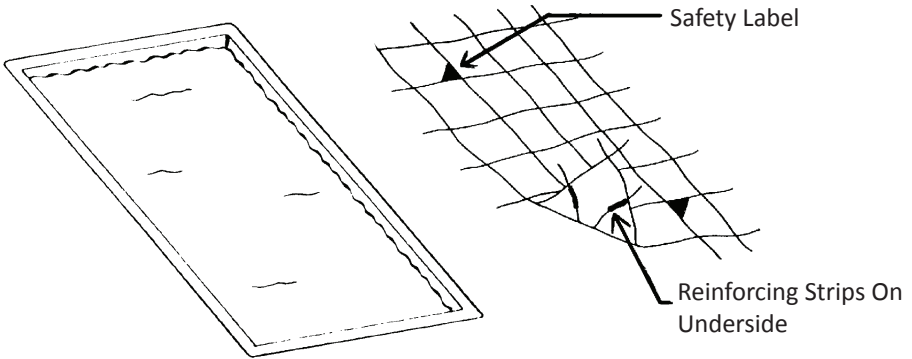

The cover should now be sagging into the pool with the material floating on the water. Attach all springs to straps by threading the strap through the spring and back through the buckle on the strap. Use the following diagram as a guide. Position the spring about 10" from the cover's edge - adjustments can be made in positioning later if needed.

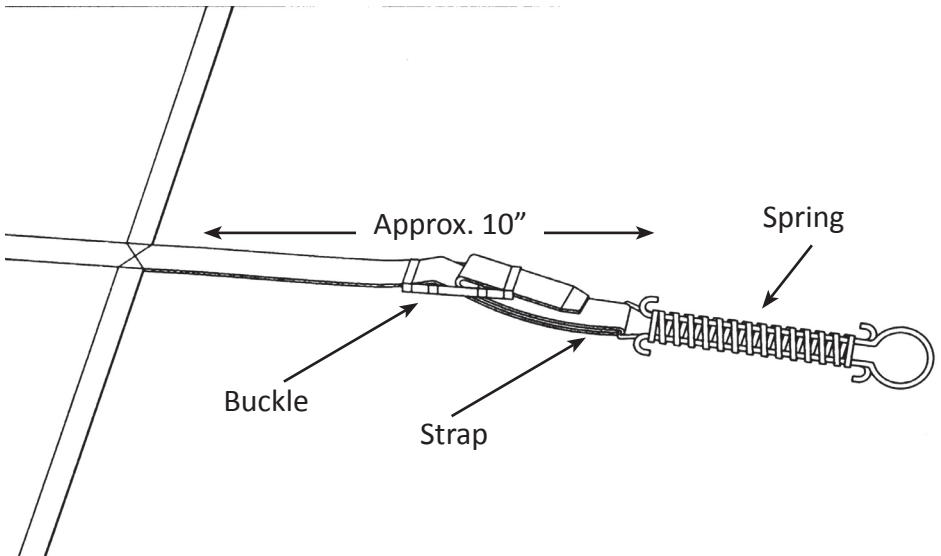

STANDARD & CUSTOM - Rectangular Covers

(look for orientation label on cover to coincide with anchor plan)

Start by anchoring both ends of a center strap (A&B) down lengthwise. (Follow the anchor drilling instructions on page 11.) Then install both ends of a center strap (C&D) across the pool width. Be sure there is an equal overlap on both sides and ends. For the proper overlap, look at the cover page of this booklet or subtract the pool size from the cover size and divide by two. Anchors should be located 20" back from the cover's edge. The correct anchor distance back from the pool edge is the core overlap plus this 20". Typically, anchors are about 32" to 38" back from the pool edge.

Install Center Strap A-B

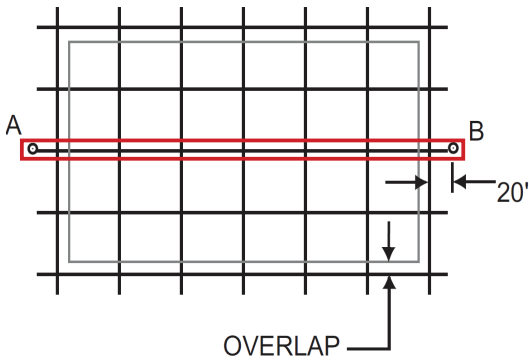

Install Cross Strap C-D

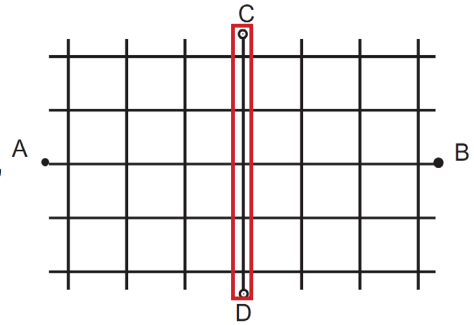

The installation can be completed by installing remaining anchors towards corners.

Install Remaining Anchors

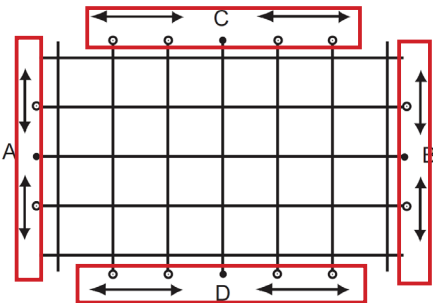

Install Corner Anchors

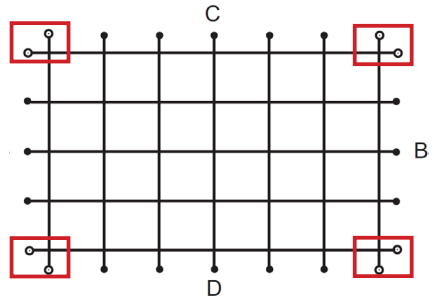

Alternative Rectangular Method

Rectangular covers may also be installed by anchoring the corners first. When using this method, it is advisable to mark the cover corner locations on the deck in chalk. Then mark the corner anchor locations by measuring 20" out from the cover corner and slightly (2") away from the center of the pool to allow for eventual cover stretch.

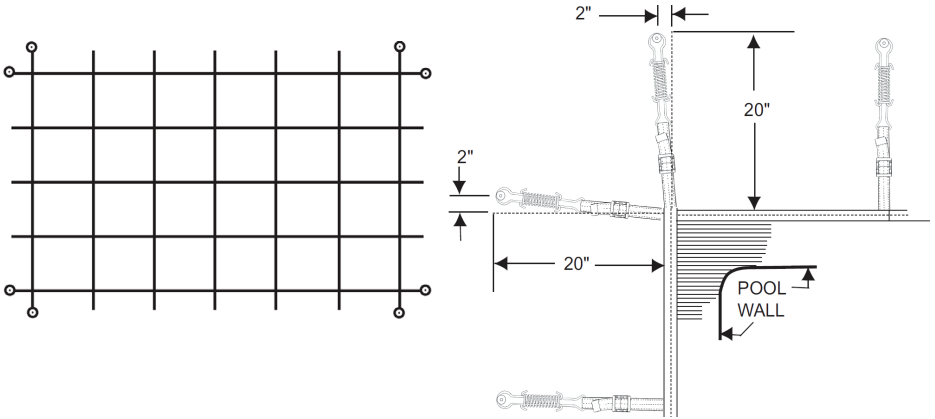

When all eight corner anchors are installed, adjust the strap through the buckles for proper tension and equal overlap. Using a chalk line or piece of string, mark a straight line between corner anchors on all four sides of deck.

Install remaining anchors down the length of pool, being sure to locate the anchor on the chalk line and pulling the cover strap straight out from the cover. Continue to do the same down the width sides of the pool.

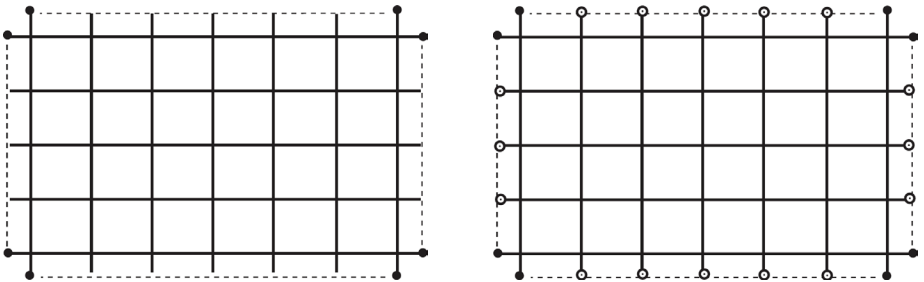

Straps and buckles can be adjusted to align straps not in perfect alignment.

Custom Shaped Covers

Water-filled containers or similar weights should be positioned on some of the straps to hold the cover in position. **Be careful not to position weights directly on the cover material as it could snag or damage the material.** If there are any obstructions, first position the cover so that cutouts fit around obstructions (e.g. rocks, rails, raised walls).

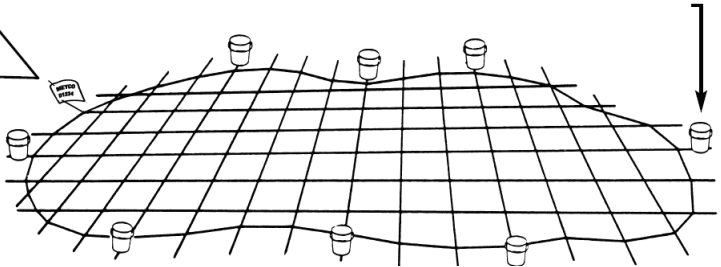
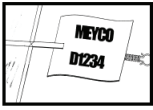

Start anchoring both ends of a center strap (A&B) down lengthwise using the drilling instructions in this manual. Then install both ends of a center strap (C&D) across the pool width. Be sure there is an equal overlap around the pool. For the proper overlap, subtract the pool size from the cover size and divide by 2. Check to be sure anchors are the proper distance back from the pool edge. Anchors should be 20" back from the cover's edge.

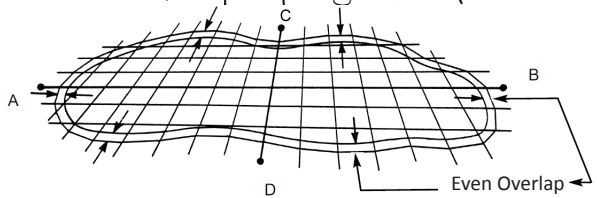

Continue to install the remaining anchors. Pull the straps out straight from the cover. Set anchors back to proper distance from the pool edge. Anchors should be located 20" from the cover's edge. The correct anchor distance back from the pool edge is the cover overlap plus the 20" distance from the cover's edge to the anchor. Typically the anchors are about 32" to 38" back from the pool edge.

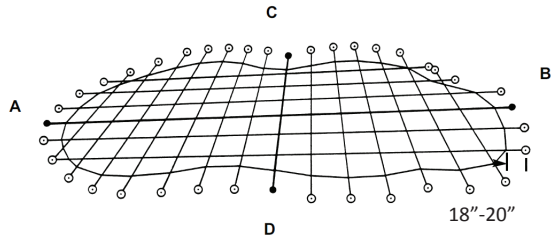

Check to be sure that all the cross webbing and straps are straight. If there are any straps not pulling straight across the cover it may be possible to straighten them by adjusting the tension (by moving the buckles) on the straps perpendicular to them.

Check for a uniform overlap around the cover. Tighten straps so that springs are compressed about halfway (approx. 2 1/2" apart) as shown in this diagram.

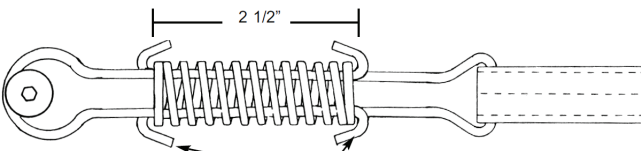

Coils compressed 2 1/2" apart (50% to 75% compressed)

Anchor Drilling

Once you have located proper anchor positions, drill holes to accept the anchor shells. Measure the drill bit beveled depth. Then add 2" for pop-up type anchors or 1 3/4" for screw-type anchors. Mark this measurement onto your tamping tool and drill bit with electrical tape or use a drill guide. Drilling dust can be removed with a vacuum or blown out.

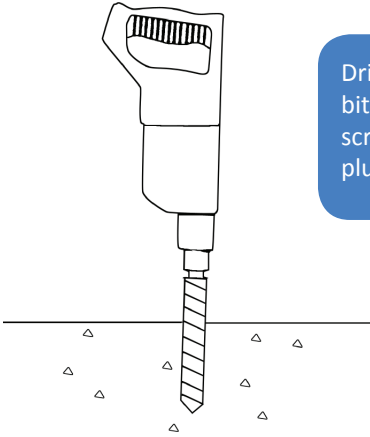

Drill hole with a 3/4" drill bit. The hole depth is 1 3/4" screw type (2" pop-up type) plus drill bit beveled depth.

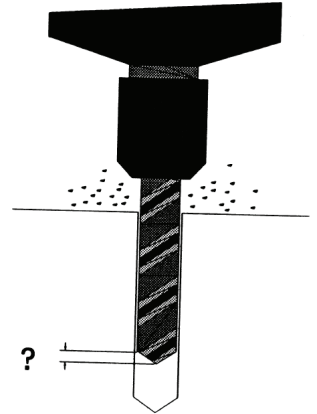

When your anchor hole is properly prepared, the anchor shell can be lightly tamped into position by inserting the tamping tool into the shell and tamping it into the deck with a mallet or hammer. A light Teflon or silicone spray on the tamping tool prior to tamping will facilitate its easy removal.

If the tamping tool should become jammed into the anchor, try gently tapping the tool on the sides to loosen it while pulling in an upward direction. For "Pop-Up Style" anchors, properly align the bevel on the tool with the inside of the anchor. Do not force it.

Always follow recommendations for personal protective equipment (PPE) from the manufacturer if using any power tools (e.g. drills) when installing cover.

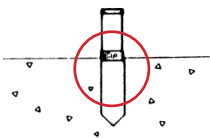

Position the anchor shell above the hole.

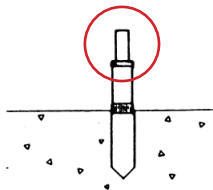

Insert tamping tool into the anchor shell.

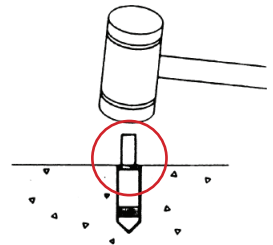

Tap tamping tool gently to set anchor flush with deck.

Fastening Springs to Anchors

Position anchor inserts in the up position using the hex key. Slide the installation rod through the loop end of the spring and position over the end of the anchor head. The elongated tip of the rod should be towards the back of the anchor (furthest from the pool). The rod should now be angled towards the pool.

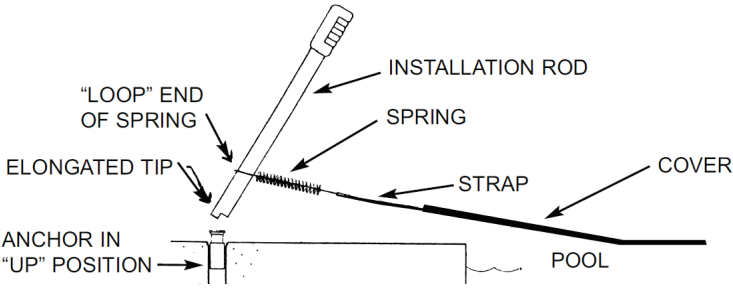

Pull the rod handle away from the pool. The spring will slide down the rod to the elongated tip. This can be facilitated by pushing down on the spring with your foot. The rod may also be lightly sprayed with silicone lubricant to ease sliding. The spring will slide off the rod and onto the anchor head.

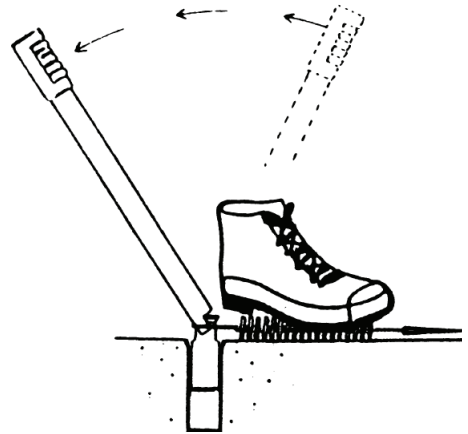

A cover should be "drum tight". A loose cover will allow "wind-whipping" which may result in coping wear on the fabric around the edge. At initial installation, we suggest that the cover be set extremely taut by adjusting strap buckles to a position where the cover tension will have the spring coils almost touching. As the cover stretches slightly, tension will lessen and springs should adjust to their normal position. Check cover tension periodically. Spring coils should be compressed about 2 1/2".

Removing Springs from Anchors

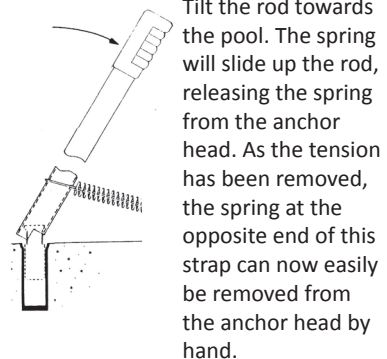
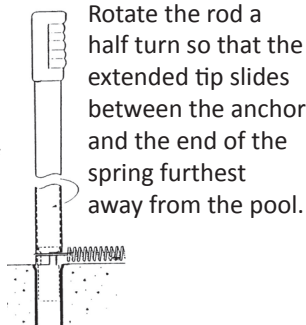
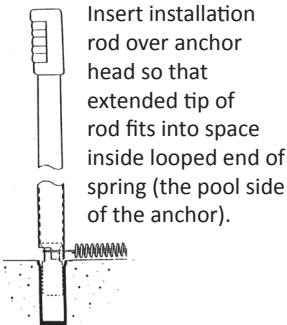

Hardware

Brass Anchors - For stable surfaces such as concrete, mortared brick or patio stone decks.

For these and other stable anchoring surfaces, anchors can be installed by simply drilling a hole with a rotary hammer drill; tamping the anchor shell into the hole; and inserting the anchor insert. A carbide tipped drill bit is often used for drilling. Diamond tipped bits are available for longer life, quicker drilling and more precisely round holes.

For low grade concrete decks and decks with veneer coatings, spalling or chipping may occur when drilling. It is advisable, in these cases, to use a slow-speed drill for the initial drilling, followed by the hammer drill setting to complete the hole. Brass anchor flanges are available (for screw type anchors only) to “cover” chipping around the anchor edges.

Standard Screw Type Anchor

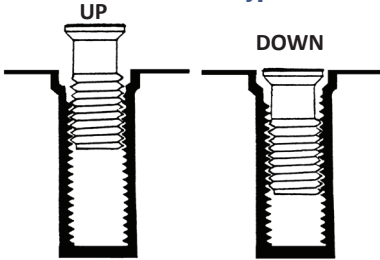

Threaded to rotate up and down

Optional Pop-Up Type Anchor

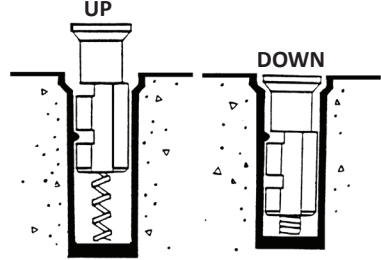

1/4 turn with spring insert to release or set into position

*note: to facilitate smooth operation it is recommended that anchor inserts be removed each spring and fall and dirt flushed out of shells. The brass inserts may also be lightly coated with a silicone or Teflon spray to ensure smooth operation. **Do not use oil or grease!***

Wood Deck Anchors - For sturdy wood decks

Meyco wood deck anchors may be used to anchor covers to wood decks capable of supporting the anchor. **It is the installer's responsibility to determine if the decking has sufficient thickness and strength to support the cover tension and the attachment of the anchor.**

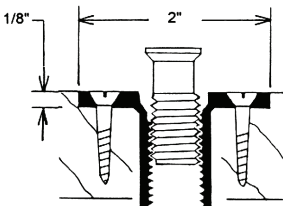

Anchors should be countersunk into decking by drilling two holes in the wood. First a 2" x 1/8" countersink for the top flange. Second, a 3/4" hole to accept the body of the anchor itself using a conventional drill bit. A 2" Forstner Bit is recommended for quick drilling of the shallow countersink hole.

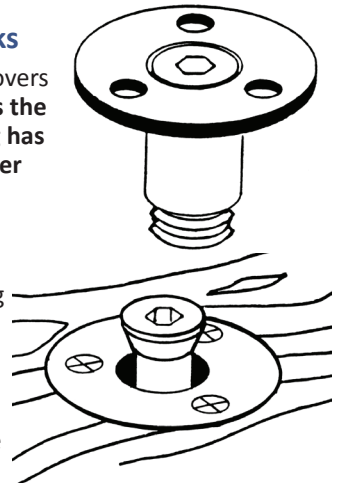

Pipe Anchors - For unstable surfaces such as loose bricks, patio stones and landscape areas

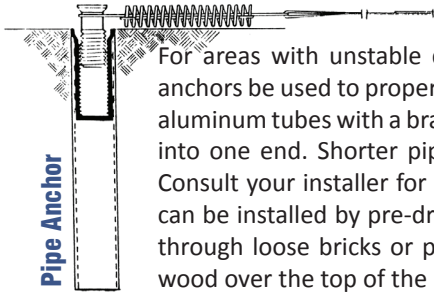

For areas with unstable decking it is recommended that Meyco pipe anchors be used to properly anchor the cover. Pipe anchors are 18" long aluminum tubes with a brass screw-type anchor permanently embedded into one end. Shorter pipes are also available for various deck types. Consult your installer for proper anchoring requirements. Pipe anchors can be installed by pre-drilling a 15/16" to 1" hole into the ground and through loose bricks or patio stones when necessary. Place a block of wood over the top of the pipe anchor assembly (or use a rubber mallet) to gently tamp into place.

Lawn Stakes - For garden and landscape areas

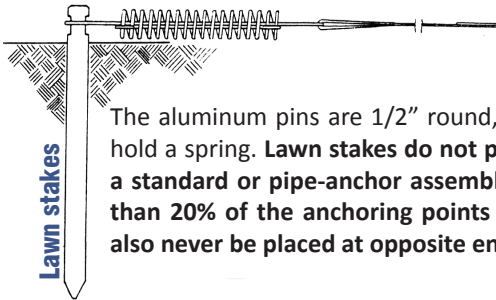

The aluminum pins are 1/2" round, 18" long, with a head at the top to hold a spring. **Lawn stakes do not provide the same degree of safety as a standard or pipe-anchor assembly and should not be used for more than 20% of the anchoring points around a pool. Lawn stakes should also never be placed at opposite ends of the same strap.**

Wall Anchors - For anchoring into vertical areas

When areas of raised decking or rocks do not allow for normal anchoring, wall anchor/ eye-bolt sets may be used to attach a cover directly to a wall. Wall anchors are inserted into a 3/8" hole drilled directly into the raised wall or rock area.

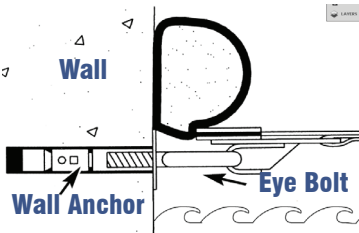

- 1 3/4" Anchor, drill 2 1/4" deep
- 2 1/2" Anchor, drill 3" deep
- 4" Anchor, drill 4 1/2" deep
- 5" Anchor, drill 5 1/2" deep
- 6" Anchor, drill 6 1/2" deep

The eye bolt is screwed into the anchor forcing the anchor to expand to a tight fit in the wall. Drill a hole at least 1/2" deeper than the anchor length

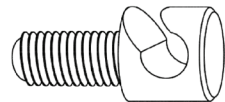

OR

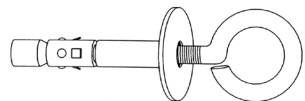

Hardware (continued)

Extension Straps

Extension straps may be used when the standard strap is not long enough to extend across a surface to reach the desired anchor location. Extension straps are available in 4', 6', and 8'. Straps in excess of 8' are not recommended as they could lead to wind whipping and premature wear. Avoid more than 20% of extension straps on a cover.

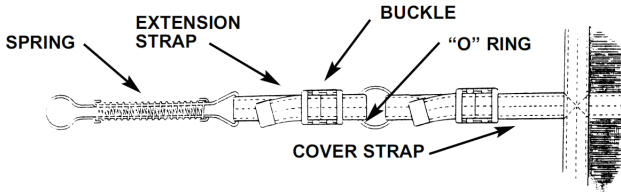

Yoke Straps Assembly

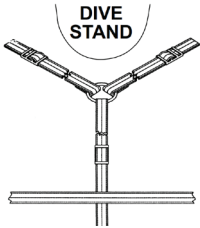

The "Yoke" or "Y" strap assembly is designed with a split strap that allows the installer to anchor around an obstacle. It is often used to secure a cover around a dive stand that can't be removed.

Proper Water Treatment for Pools with Meyco Safety Covers

RECOMMENDED STEPS FOR CLOSING THE POOL

1. Bring pool into proper chemical balance.
2. Superchlorinate pool.
3. Add winter chlorinating floaters.
FOR WHITE PLASTER OR PAINTED POOLS ONLY.
4. Add prescribed quantity of Algaecide.
5. Add a stain and scale control chemical if necessary.
6. Drop water level to prevent ice from freezing tile.
BUT NOT MORE THAN 18" FROM TOP OF POOL!
7. Prepare equipment for winter.
Cover pool and adjust straps to ensure cover is "drum tight".
Insert padding between cover and any wear points.

MONITORING WATER CONDITIONS DURING WINTER

A number of factors may contribute to the possible formation of algae once the appropriate winterizing chemicals have become depleted. These conditions include the amount of sunlight entering the pool, the length of time that the pool is closed and air temperatures in excess of 60 degrees. Obviously, a pool closed just after Labor Day runs a greater risk of reduced chemical concentrations (and protection) than one which remained open until Thanksgiving.

The best way to determine if algae growth may be occurring is to periodically check water conditions by removing a corner of the cover. This procedure is especially recommended during unseasonably warm periods when air temperature is 60 degrees or higher. If you suspect that water conditions are deteriorating, the appropriate algaecide chemicals should be added before the pool is completely opened for use.

If the pool will not be opened until late Spring, you may want to hook up the equipment 30-60 days prior to opening and run it several hours per week to create circulation which will also enhance the distribution of any algaecide. During this time be sure to maintain frequent inspections since warmer weather may accelerate the depletion of algaecide chemicals.

OPENING THE POOL

A small quantity of very fine silt may pass through mesh safety covers and accumulate over an extended time period. However, this is easily removed during an initial vacuuming of the pool when it is opened. Most debris will remain on top of the cover to eventually dry up and blow away.

NOTICE

Use and Care of Your Meyco Cover

- Never allow the pool's water level to fall below 18" from the main deck level. A low water level will result in cover and/or spring damage during periods of snow accumulation. **This damage will not be covered under the warranty.**
- Do not walk on the cover except in an emergency situation. Do not jump on the cover like a trampoline. **Walking or jumping on the cover may result in damage to the cover not covered by the warranty.**
- The pool water must be properly chemically treated when closing the pool for the winter. The water chemical level should be checked in early spring or when there is any period of warm temperature. Proper adjustment of chemicals should be made if necessary.
- Abrasion strips are sewn to the cover to protect against normal coping wear. **The cover should be kept drum tight to help lessen the chance of excessive wear not covered under the warranty.**
- It is the responsibility of the installer to add protective padding to sharp corners or very rough areas of the pool, if necessary. Vinyl padding or carpet remnants may be used for such protection.
- The cover should be folded and stored in its storage bag when not in use. Leaves and debris should be removed. The MeycoLite covers do not need to be scrubbed down or powdered prior to storage.
- RuggedMesh covers should be hosed down from the bottom side to unclog filters.
- PermaGuard solid and RuggedMesh covers should be cleaned with a mild detergent and dried before storing.
- The cover should be stored in an area free of rodents.
- Always completely remove the cover when using the pool. **Never swim in the pool with the cover partially installed.**
- Check the cover periodically to be sure the cover is secured drum-tight on the pool. Adjust the buckle positions to achieve the proper tension.
- Do not drag the cover on decking or over the cover springs. **Tears resulting from mishandling will not be covered under the warranty.**
- Do not operate a barbeque grill in the proximity of the cover as sparks or hot ash may settle on the cover and result in small burn holes.



PATENTED IN THE U.S.

Everyone Trusts the Original.™

Headquarters
1225 Walt Whitman Road
Melville NY 11763

Moore Facility
7601 Highway 221
Moore, SC 29369

(800) 446-3926 | sales@meycoproducts.com | meycocovers.com

 [MeycoCovers](#)

 [MeycoPoolCovers](#)

 [meyco-pool-covers](#)