

IMPORTANT NOTE: For the most up-to-date version of this manual, please visit www.h2flow.net/product-literature

FLOWVIS®

FLOW METER

Operating Manual

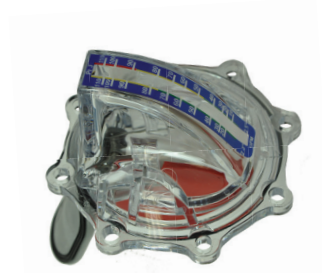

TABLE OF CONTENTS

Description	3	Operation	
Concept	3	Reading the Flow Rate.....	10
Resources	3	Velocity Indication.....	10
Service Repair Kit	3	Head Loss Data	11
Models & Specifications	4	Dimensions	14
Markings, Features, Warnings & Safety	5	Maintenance	17
Installation Locations		Technical Data	
Systems using Salt Generator Cells.....	6	Material Data Sheet (MSDS).....	18
Systems using Erosion Chlorine Feeders.....	6	Operational Data.....	19
Installation		Straight Pipe Requirements.....	19
General Installation Guidance.....	7	Warranty	back cover
Certified NSF 50 Accuracy and Associated Pipe Configurations.....	7		
Pipe Configurations other than those used by NSF for Testing.....	8		
NSF 50 Accuracy Levels.....	8		
Installation of Saddle-clamp models.....	8		
Installation of Union-style models.....	9		
Tightening Lid Screws.....	9		



Above: FV-25/FV-25-L, FV-3/FV-3-L, FV-4/FV-4-L, FV-6/FV-6-L and FV-8/FV-8-L



Above: FlowVis® retrofit model

CONCEPT

As flow increases, the flapper moves forward toward its fully open position. The flapper's angular position is directly related to the flow rate through the valve body / tee / pipe. A calibrated scale on the valve's lid provides a highly accurate reading of the flow rate and velocity.

RESOURCES

Thank you for purchasing the H2flow FlowVis® flow meter. If you would like to find additional product resources, including tech tip sheets, brochures, videos, and materials in other languages, please visit our website at www.h2flow.net or scan the QR Code below.



DESCRIPTION

FlowVis® is a revolutionary, patented solution for accurate and reliable flow and velocity rate measurement in fresh water applications such as swimming pools, spas, fountains, water features, irrigation systems, ground water applications, well water and solar systems. A FlowVis® model also exists for Flotation Tanks and where the Specific Gravity has been raised to 1.25 by adding Epsom Salts.

Using a design that is based on 'mass flow' principles, the FlowVis® provides many benefits that include:

- Ease of installation with zero to minimal straight pipe
- Installation flexibility that allows orientation in any position, e.g., horizontal, vertical or even upside-down
- Long life without sticking floats or paddle wheels
- Combined Flow Meter and Check Valve for models FV-15, FV-2, FV-25, FV-C, all retrofit models, and all metric and DN equivalents
- User upgradeable to include Digital functionality (FV-D)

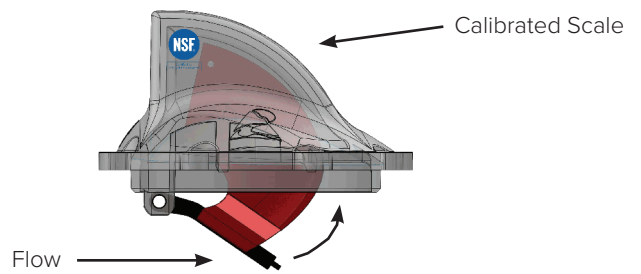

SERVICE REPAIR KIT

Service repair kits are available for all models:

FV-SK for all 1.5", 2", and 2.5" models, comprising:

- 1 x o-ring
- 1 x spring
- 1 x flapper and indicator arm (for all models except FV-C-S, and FV-C-Saline)
- 1 x pivot pin

FV-SK-CAR for all 3", 4", 6", and 8" models, comprising:

- 1 x o-ring
- 1 x spring
- 1 x spring pulley pivot pin
- 1 x spring pulley to flapper pulley wire

For all other parts, please contact H2flow at 888-635-0296 (toll-free) or (+1) 419-841-7774 (International).

MODELS & SPECIFICATIONS

FlowVis® comprises several models; it is important that you check that the model you are about to install is the correct one for your application. **NOTE:** For metric equivalents, please refer to the metric version of this manual.

Model	Configuration			Pipe Diameter								Pipe Schedule		Scale		Special				Body Type			NSF 50 Certified	Flow Range		
	Complete	Jandy	Retrofit	1.5"	2"	2.5"	3"	4"	6"	8"	40	80	GPM	LPM	Safety	Saline	High Flow	Union body	Valve	Tee	Saddle clamp	GPM		LPM		
FVJ-R-15		•		•							•		•						N/A				10-90	N/A		
FVJ-R		•			•	•					•		•												10-110	
FVH-R-15			•	•							•		•												10-90	
FVH-R			•	•	•						•		•												10-110	
FVP-R-15				•	•						•		•												10-90	
FVP-R				•	•	•					•		•												10-110	
FVJ-R-15-L		•		•							•		•												40-360	
FVJ-R-L		•			•	•					•		•												40-400	
FVH-R-15-L			•	•							•		•												40-360	
FVH-R-L			•	•	•						•		•												40-400	
FVP-R-15-L				•	•						•		•												40-360	
FVP-R-L				•	•	•					•		•												40-400	
FV-15	•			•							•		•						•			•	10-80	N/A		
FV-15-L	•			•							•		•						•			•	N/A	38-303		
FV-2	•				•						•		•						•			•	10-110	N/A		
FV-2-L	•				•						•		•						•			•	N/A	38-416		
FV-25	•					•					•		•						•			•	10-110	N/A		
FV-25-L	•					•					•		•						•			•	N/A	38-416		
FV-3	•						•				•		•						•			•	70-240	N/A		
FV-3-40	•						•				•		•						•			•	70-240	N/A		
FV-3-L	•						•				•		•						•			•	N/A	165-908		
FV-4	•							•			•		•						•			•	150-460	N/A		
FV-4-L	•							•			•		•						•			•	N/A	568-1740		
FV-6	•								•		•		•							•		•	300-1000	N/A		
FV-6-L	•								•		•		•							•		•	N/A	1136-3785		
FV-8	•								•		•		•							•		•	600-1800	N/A		
FV-8-L	•								•		•		•							•		•	N/A	2271-6814		
FV-15-U	•			•							•		•					•	•			•	10-90	N/A		
FV-2-U	•				•						•		•					•	•			•	10-110	N/A		
FV-C-S	•				•						•			•					•			•	30-110	N/A		
FV-C-S-L	•				•						•			•					•			•	N/A	110-400		
FV-C-Saline	•				•						•				•				•			•	20-100	N/A		
FV-C-L-Saline	•				•						•		•						•			•	N/A	80-400		
FV-C-HF-S	•					•					•		•				•		•			•	30-190	N/A		

COMPATIBILITY NOTE: When selecting a 'retrofit' model from the table above, it is important to select the FlowVis® model designed for your particular valve body. Each manufacturer's design has unique hydraulic characteristics that requires a specific FlowVis® scale.

MARKINGS, FEATURES, WARNINGS & SAFETY

NSF 50

Models certified to NSF 50 will display the mark as shown to the right:

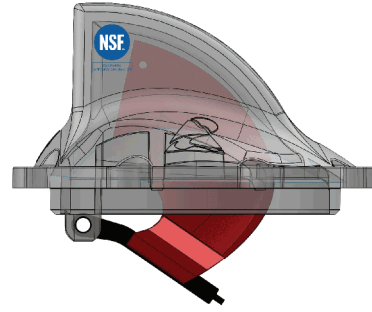

Valve Body Feature

On the side of the valve body that is used for the 1.5", 2", and 2.5" models, you will note the following feature:



This feature has no functionality relating to the operation of the FlowVis® and is simply provided as an attribute to be able to plumb in a drain down pipe and valve. A typical use for this might be a roof mounted solar system. Under no circumstances should this hole be drilled out when using the valve body with the FlowVis®.

Tygon Tubing

For models FV-3, FV-3-L, FV-4, FV-4-L, FV-6, FV-6-L, FV-8 and FV-8-L, the Tygon tubing feature shown in the images to the right, is installed to assist with initial air extraction from the FlowVis lid after the pump is started. When installing the lid assembly into the Tee (FV-3, FV-3-L, FV-4 or FV-4-L) or Saddle (FV-6, FV-6-L, FV-8 or FV-8-L), care should be taken to ensure that the end of the Tygon tubing is positioned downstream of the FlowVis, i.e., not tucked up inside the FlowVis lid, Tee or Saddle. This feature creates a venturi effect that will cause a negative pressure at the end of the tubing, thereby expelling air from inside the lid. For applications using a variable speed pump, it is advisable to initially run the pump at the highest possible safe speed in order to extract any air in the lid.



Warnings & Safety

The Virginia Graeme Baker Pool & Spa Act requires that all public swimming pools & spas having a single main drain or multiple drains that are 3 feet or less (center to center) from each other be fitted with a backup anti-entrapment system. Such systems include, but are not limited to, SVRS and Automatic Pump Shut Off systems. Special consideration must be made when installing a FlowVis® to such applications. Several of these systems do not allow the use of Check Valves. It is the responsibility of the installer to make sure that the requirements of the specific backup system in use are maintained.

For these applications, refer to model FV-C-S in the model table on Page 4.

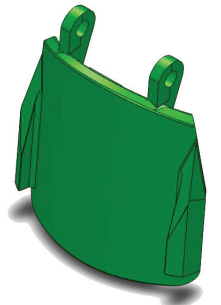

■ INSTALLATION LOCATIONS

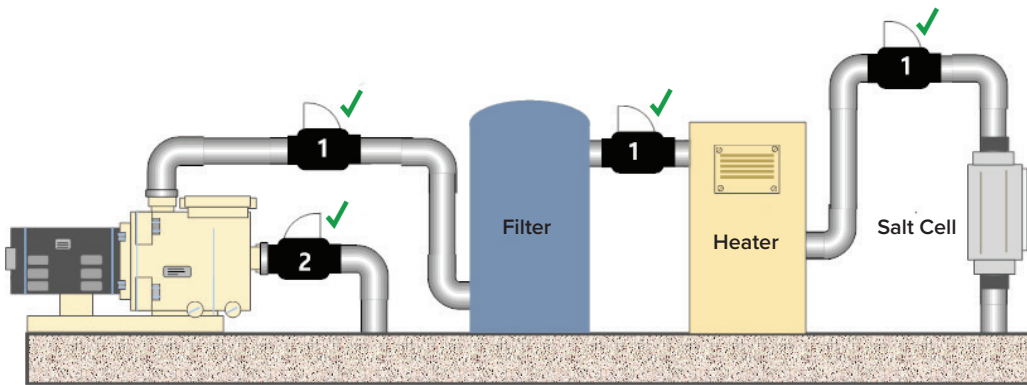

LEGEND

- 1 = IDEAL ✓
- 2 = GOOD ✓
- 3 = ACCEPTABLE X
- 4 = AVOID X

Systems using Salt Generator Cells

Due to the fact that Salt Generator Cells have their electrical supply turned off under low or low flow conditions, there is virtually no possibility of damage being caused to the FlowVis unit by these devices. Therefore, the primary installation consideration is where will the unit provide the greatest benefit to the customer. For example, it is generally recommended that there is a Check Valve installed between the Chlorine Feeder / Generator and the Heater. Given that FlowVis models for 1.5", 2" and 2.5" plumbing have an integrated Check Valve, this would be an ideal location to install FlowVis.

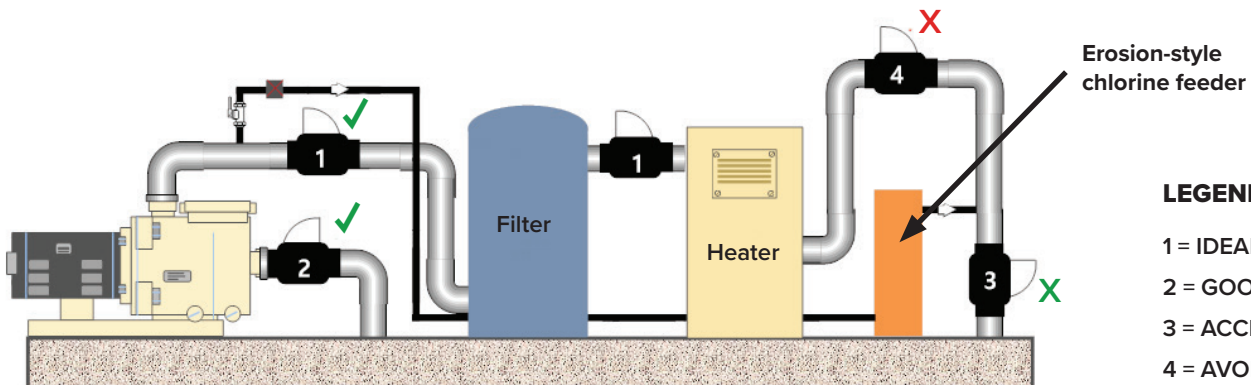

LEGEND

- 1 = IDEAL ✓
- 2 = GOOD ✓
- 3 = ACCEPTABLE X
- 4 = AVOID X

Systems using Erosion Chlorine Feeders (hockey puck-style)

Material selections such as corrosion resistant Viton and Hastelloy c-276 ensure that FlowVis® will provide many years of trouble-free operation in normally treated, sanitized pool water conditions. However, certain brands and designs of inexpensive Erosion Chlorine feeders are known to fail and release high concentrations of chlorine or even chlorine gas into the surrounding filtration system. When this occurs, any equipment that comes into contact with these abnormal levels of chemicals will experience premature failure.

When this occurs, an inspection of the components within the FlowVis will quickly confirm the cause of the damage and, under these circumstances, the product's **warranty will be void.**

Under no circumstances should FlowVis® be used as a 'check valve' to prevent the effects of these Chlorine Feeders damaging other equipment such as Heaters.

INSTALLATION

General Installation Guidance

IMPORTANT NOTE: Before installing the FlowVis®, please refer to the preceding section on Page 6 regarding chlorine feeders.

Installation of FlowVis® should be in accordance with the following instructions.

Normal plumbing procedures such as cleaning, priming and gluing of fixtures should be followed in order to avoid leaks. If you are not familiar with plumbing procedures, it is recommended that you employ the skills of a qualified plumber.

Unlike other flow meters, the majority of FlowVis® models are not affected by flow stream disturbances caused by its proximity to pumps, elbows, tees, valves, etc. FlowVis® can be installed either horizontally or vertically. Straight pipe requirements are addressed in the table on page 19.

Pay particular attention to the system’s direction of flow and make sure that the arrow on the lid of the FlowVis® is pointing in the correct direction. For the FV-3, FV-3-L, FV-4, FV-4-L, FV-6, FV-6-L, FV-8 and FV-8-L versions, the Tee / Saddle-clamp will feature an additional arrow label. In the event that the FlowVis® is inadvertently installed into the plumbing in the wrong direction, simply remove the (8) screws holding the lid in place and rotate the entire lid assembly by 180°.

NOTE: For all models 2.5” and smaller, always remove the FlowVis® lid assembly prior to gluing in the valve body.

NOTE (1): When selecting a physical location to install FlowVis®, be sure to allow accessibility to read the scale on the lid.

NOTE (2): Due to the possibility of excessive turbulence, models FV-3, FV-3-L, FV-4, FV-4-L, FV-6, FV-6-L, FV-8 and FV-8-L should not be installed directly after the pump.

NOTE (3): FlowVis models are designed for the specific pipe Schedule stated at the bottom of the flow scale label. While it is important to comply with the specific Schedule of pipe, the accuracy stated within this manual can be maintained if a short length (3-6 inches / 75-150mm), of the correct pipe type, is installed either side of the FlowVis. For example, an FV-3 / FV-3-L, can be installed to a SCH 40 plumbing system, provided that a short length of SCH 80 pipe is installed into each end of the FlowVis FV-3 / FV-3-L.

Certified NSF 50 Accuracy and Associated Pipe Configurations

Model	NSF 50 Level	Pipe Configuration
FV-15, FV-15-L	L1	A
FV-15-U	L1	A
FV-2, FV-2-L	L1	A
FV-2-U	L1	A
FV-25, FV-25-L	L1	A
FV-C-S	L1	A
FV-C-Saline	L1	A
FV-3, FV-3-L	L1	B
FV-3-40	L1	B
FV-4, FV-4-L	L1	C
FV-6, FV-6-L	L1	D
FV-8, FV-8-L	L1	E

Pipe Configuration Definitions:

- A.** Zero straight pipe before or after FlowVis. Can be installed in any orientation - horizontal, vertical up or vertical down.
- B.** Straight horizontal pipe of ≥11” before FlowVis
- C.** Straight horizontal pipe of ≥17” before FlowVis
- D.** Straight horizontal pipe of ≥33” before FlowVis
- E.** Straight horizontal pipe of ≥64” before FlowVis

Pipe Configurations other than those used by NSF for Testing

Piping configurations that are more demanding than those used by NSF for testing FlowVis, e.g., installing an FV-3 right next to another fitting such as an elbow, will result in a lower accuracy level than stated above. It is impossible to determine the exact impact that each scenario will have, but like all flow meters installed in larger pipe sizes, turbulence becomes an issue. The longer the run of straight pipe before the FlowVis, the better.

NSF 50 Accuracy Levels

The NSF 50 Standard for flow meters, has five levels of accuracy (L1-L5) that are expressed as follows:

Level 1 (L1) - Average of absolute values of all single point deviations must be $\leq 2\%$. Single point deviations shall not exceed $\pm 4\%$.

Level 2 (L2) - Average of absolute values of all single point deviations must be $\leq 5\%$. Single point deviations shall not exceed $\pm 7.5\%$.

Level 3 (L3) - Average of absolute values of all single point deviations must be $\leq 10\%$. Single point deviations shall not exceed $\pm 12.5\%$.

Level 4 (L4) - Average of absolute values of all single point deviations must be $\leq 12.5\%$. Single point deviations shall not exceed $\pm 15\%$.

Level 5 (L5) - Average of absolute values of all single point deviations must be $\leq 15\%$. Single point deviations shall not exceed $\pm 20\%$.

Installation of Saddle-clamp style models (FV-6, FV-6-L, FV-8 and FV-8-L)

FlowVis models FV-6 and FV-8, use Schedule 80 Saddle Clamps. Dimensional details are as follows:

FlowVis Model	Saddle Size	Hole to be Drilled in Pipe	Angle for Hole / Saddle Clamp
FV-6 / FV-6-L	6" x 3"	3"	45°
FV-8 / FV-8-L	8" x 4"	4"	45°

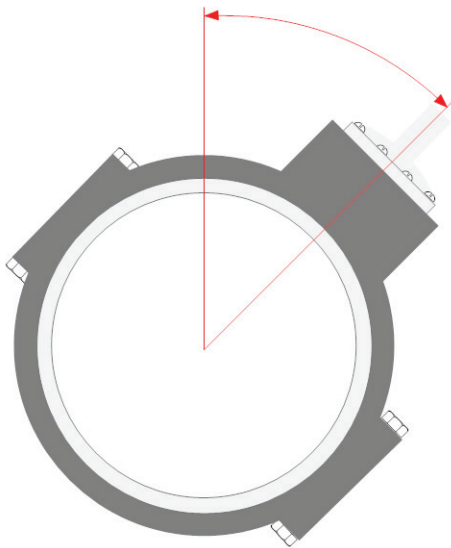

When drilling the hole, the following precautions should be taken:

1. Prior to drilling, make sure that the intended hole will be at 45 degrees from the perpendicular.
2. Ensure that the intended position will allow the user to read the FlowVis scale on the lid. If this is not possible, then we recommend adding a FlowVis Digital upgrade to enable the flow reading to be read remotely. **NOTE:** Models FV-8 and FV-8-L include FlowVis Digital as standard.
3. Do not damage the external pipe area around the drilled hole. Surface damage will result in the Saddle's o-ring being unable to provide a watertight seal.
4. If using a hole saw, it is advisable to run the drill in reverse, and although this will take longer to cut through the pipe, it will be less aggressive and will cut a cleaner hole.
5. Be sure to obtain the correct sized hole saw.

Before securing the Saddle Clamp to the pipe, apply a good quality o-ring lubricant to the o-ring. Install the o-ring into the socket on the underside of the upper-half of the Saddle Clamp. Position the Clamp to the pipe so that the o-ring is centered around the drilled hole. Evenly tighten the nuts and bolts until both halves of the Saddle Clamp are mated together.

Installation of Union-style models (FV-15-U and FV-2-U)

Union style valve bodies are available for 1.5" and 2" FlowVis models and are designated FV-15-U and FV-2-U, respectively. The Union style valve body offers two main advantages:

1. Ease of installation for retrofitting to existing plumbing, and where it is difficult to 'spread' the pipe for the standard FlowVis valve body, and;
2. Where the user wishes to uninstall the FlowVis during cold winter months

As with all Union style fittings, **it is essential that accurate measurements are taken** before cutting out the section of pipe. The ends of the cut pipe must be cut square. Removing too much pipe will prevent the union fitting from tightening up, and leaks will occur. Cutting out insufficient pipe will result in difficulty inserting the valve body in-between the unions.

IMPORTANT NOTE: Be careful to slide the two locking rings onto each pipe end **before** gluing on the union flanges.

The amount of pipe to be removed is as follows:

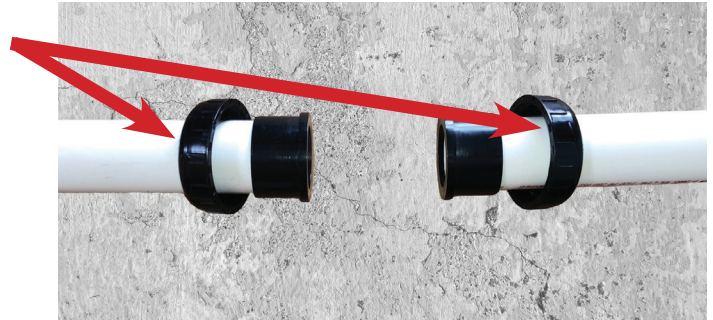
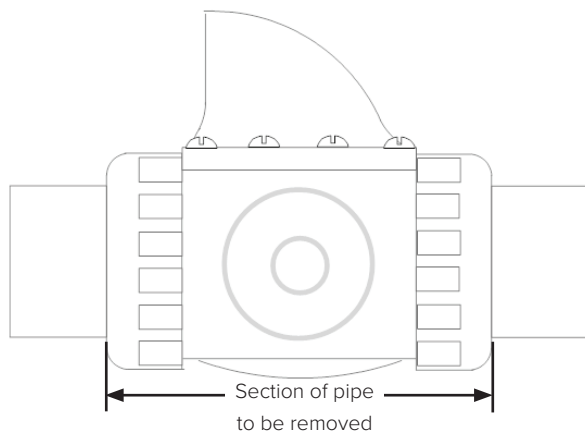

Length of pipe to be removed

Model	Inches (decimal)	Inches (fraction)	mm
FV-15-U	5.81"	5 ¹³ / ₁₆ "	147.6 mm
FV-2-U	5.72"	5 ²³ / ₃₂ "	145.3 mm

NOTE: The lid assembly from the standard valve body cannot be transferred to a union style valve body (and visa-versa), due to the flow reading being different.

Tightening Lid Screws

When installing the Retrofit versions of FlowVis® or when removing and re-installing the FlowVis® lid assembly, it is important to adhere to the following procedure:

1. Make sure that the o-ring on the underside of the lid is undamaged, lubricated with silicone (such as Boss 820) and is in-place without twists.
2. Ensure flapper hinge pin is centered.
3. Carefully lower the lid onto its valve body, Tee, or Saddle-Clamp, making sure that the o-ring stays in place.
4. Insert by hand the (8) stainless steel screws but do not tighten at this stage.
5. Using a hand Phillips-head screwdriver, slowly tighten the screws in a diagonal pattern, per the sequence to the right. Do not fully tighten one screw before proceeding to the next, i.e., pull them down slowly multiple times to avoid stressing and cracking the lid. Screws should be tightened to a final torque of 25 inch / pounds or 2.8 Nm.

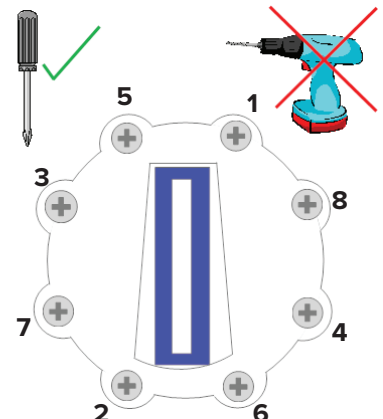

OPERATION

Reading the Flow Rate

The FlowVis® is factory-calibrated to be extremely accurate across its full operating range. Any perceived 'inaccuracy' is related to the viewing angle at which the scale is being read. To avoid so-called 'parallax error', it is important to position your eye so that you are looking squarely at the tip of the indicator arm. To achieve this, simply move your head so that you just lose sight of the vertical leading edge of the red arm.

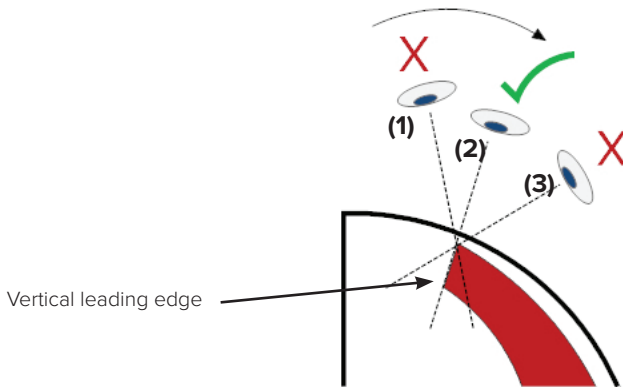

NOTE: Slowly move your head in this direction to the point where the leading edge of the indicating arm is not visible.



(1) Indicator arm is being viewed too far forward / near the rear of the lid.



(2) Indicator arm is being viewed correctly.



(3) Indicator arm is being viewed too far back / front of the lid.

Reading the Velocity Rate

FlowVis® includes a unique Velocity readout that is not found on any other flow meter. The left-hand side of the scale has a reading of the flow rate, while the right-hand side has a reading of the velocity rate.

In order to accurately read either the flow or velocity rate, please follow the instructions described in the preceding section.

The color background of the velocity scale relates to the widely accepted understanding by professionals in the Recreational Water industry, that the velocity of water traveling through a pipe shall not exceed six feet per second on the suction side of a pump or eight feet per second on the discharge side.

The background color shows a 'step' feature that differentiates the Suction (S) and Discharge (D) areas. Note that not all models will show the 'S' and 'D' at the top of the velocity scale. For these models, note that suction readings are on the left and discharge readings on the right of the right-hand side (ft/s) side of the scale.

IMPORTANT: The flow rate should never enter the 'red' area of the scale for either configuration.

The velocity rate values are related to the specific pipe type shown at the bottom of the scale.

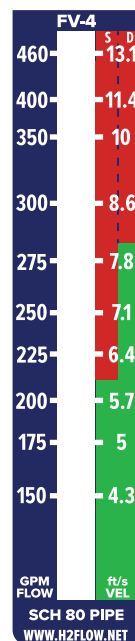

Refer to the 'S' column if FlowVis is installed to the suction side of the pump.

Refer to the 'D' column if FlowVis is installed to the discharge side of the pump.

NOTE: For FlowVis scales that do not feature an 'S' and a 'D', the area to the left of the blue dashed line represents 'Suction', and to the right represents 'Discharge'.

This red colored area represents a velocity range that it is not recommended any pump operates within (≥ 6 ft/s on the suction side and ≥ 8 ft/s on the discharge side of the pump).

This green colored area represents a safe operating velocity range (< 6 ft/s on the suction side and < 8 ft/s on the discharge side of the pump).

This area of the scale denotes the schedule pipe that the FlowVis model has been calibrated to. Schedule 40 for 1.5", 2", 2.5" and 3" FV-3-40 models and Schedule 80 for 3", 4", 6" and 8" models.

HEAD LOSS DATA

Head Loss (FV-15 / FV-15-L):

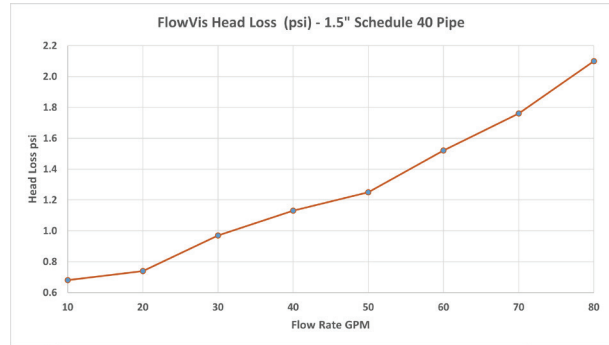
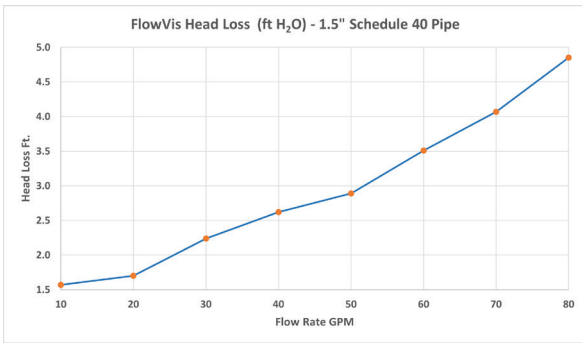

Head Loss (FV-15-U):

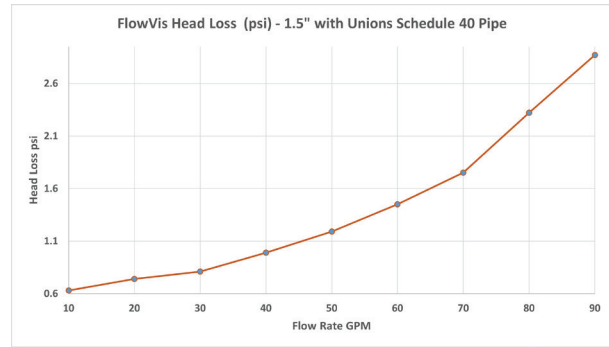
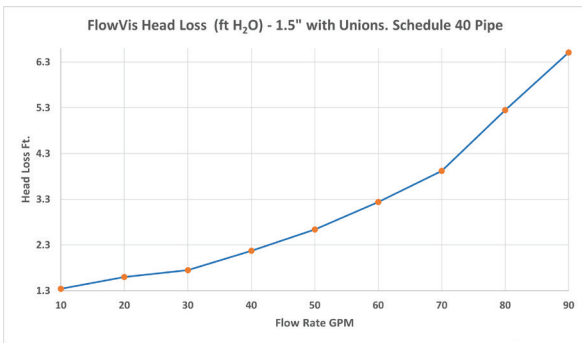

Head Loss (FV-2 / FV-2-L):

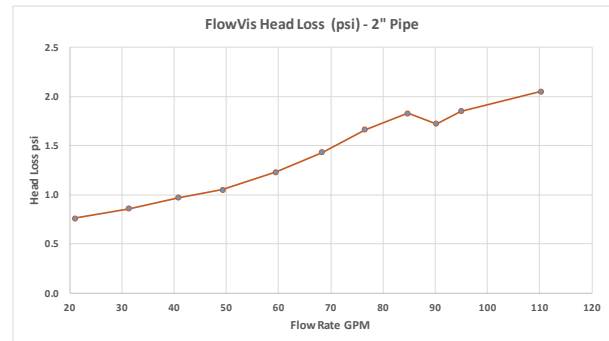
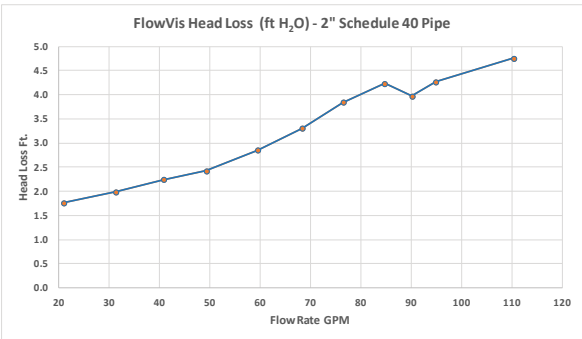

Head Loss (FV-2-U):

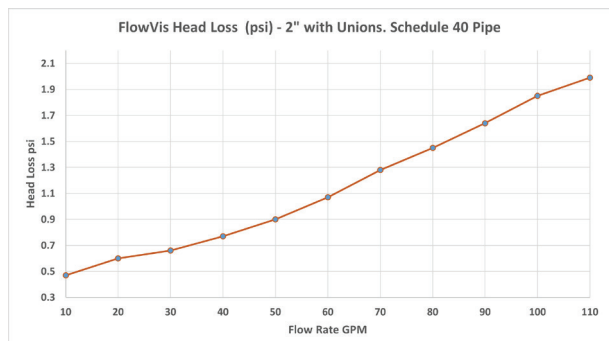
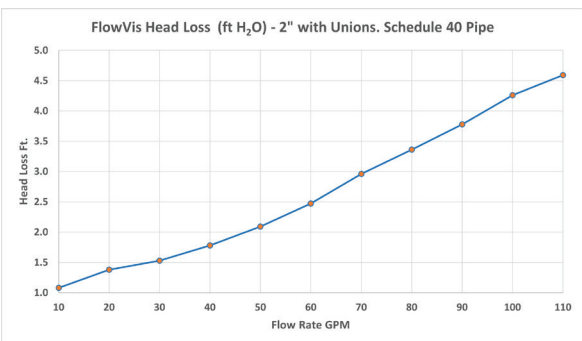

Head Loss (FV-25 / FV-25-L):

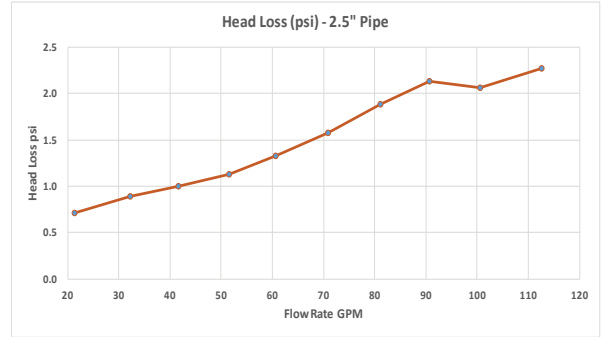
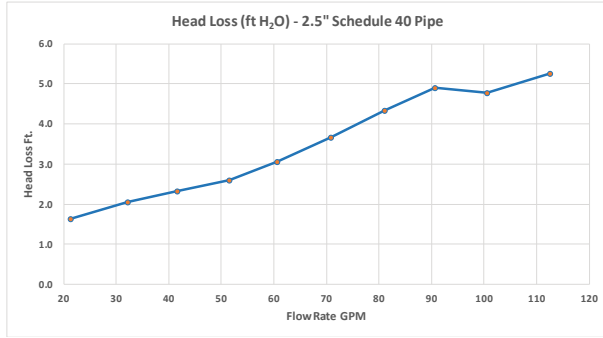

Head Loss (FV-C-S):

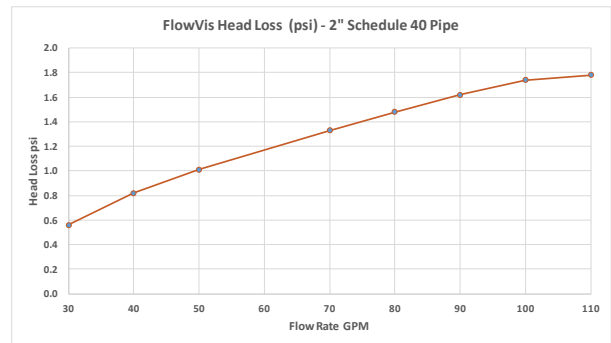
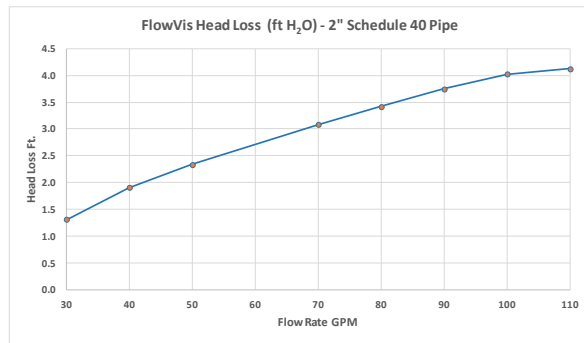

Head Loss (FV-C-Saline):

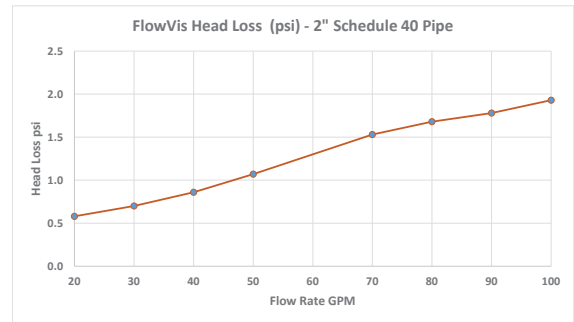
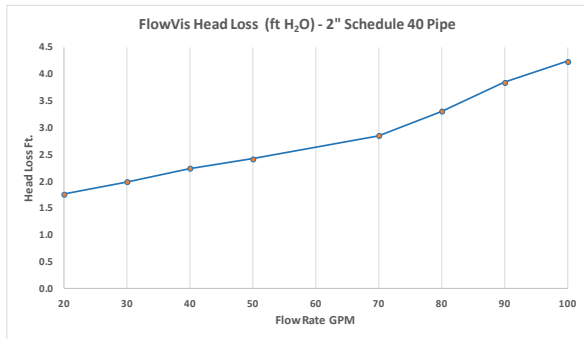

Head Loss (FV-3 / FV-3-L):

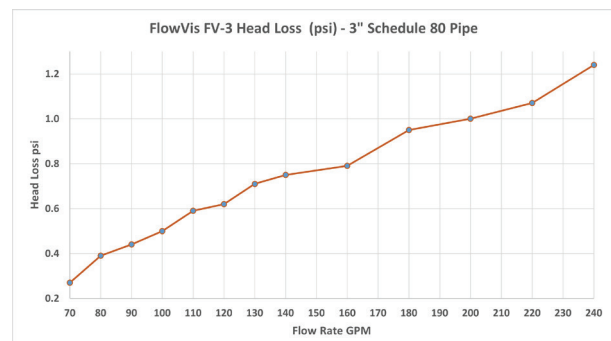
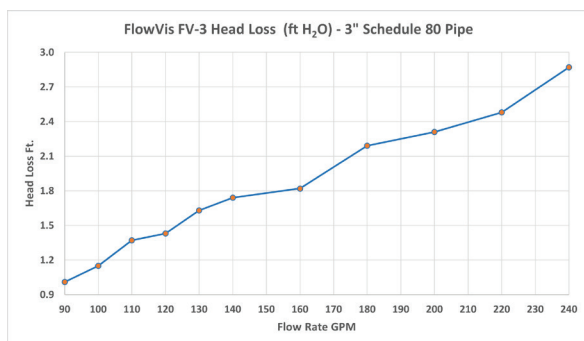

Head Loss (FV-3-40):

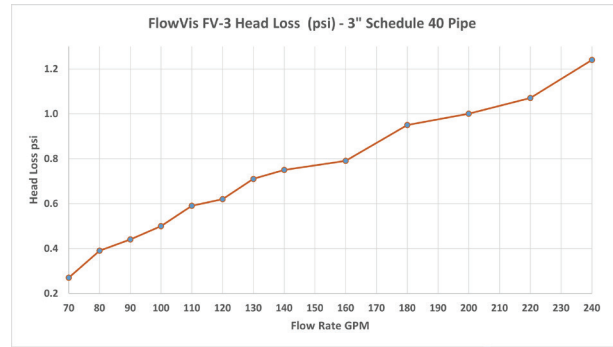
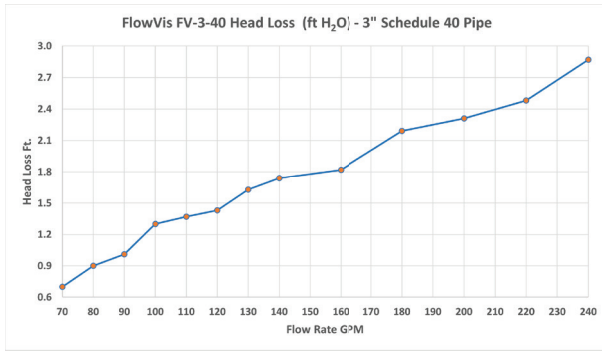

Head Loss (FV-4 / FV-4-L):

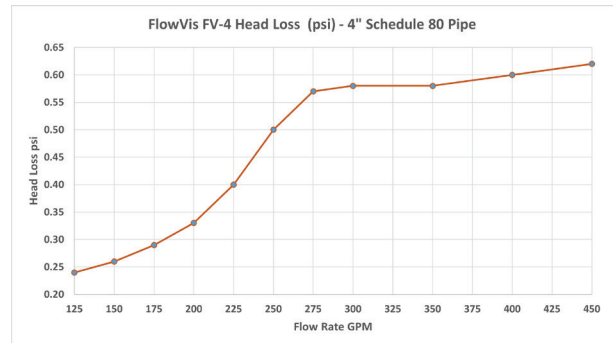
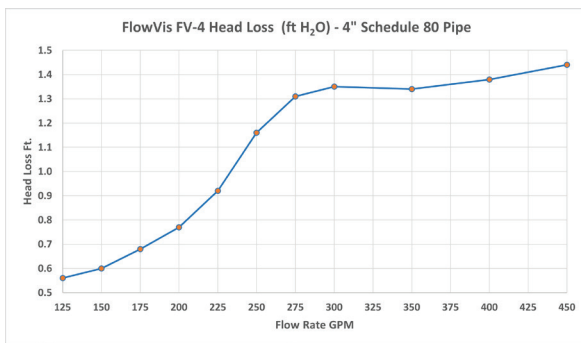

Head Loss (FV-6 / FV-6-L):

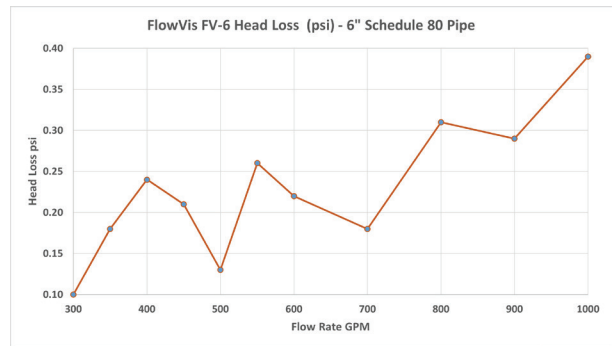
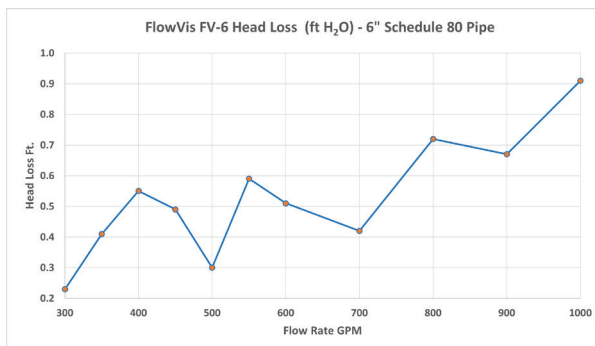

Head Loss (FV-8 / FV-8-L):

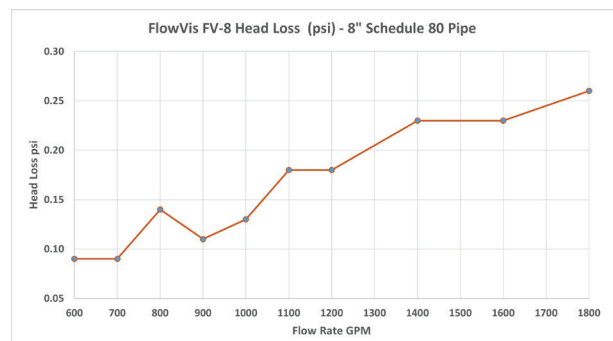
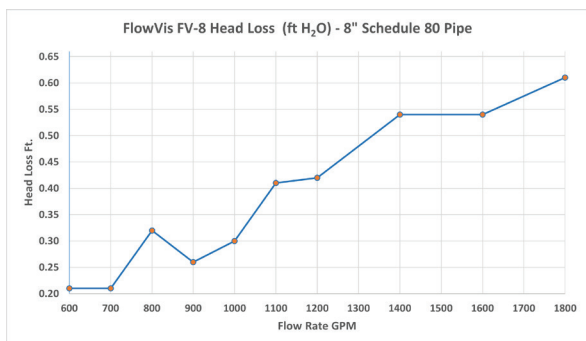

DIMENSIONS

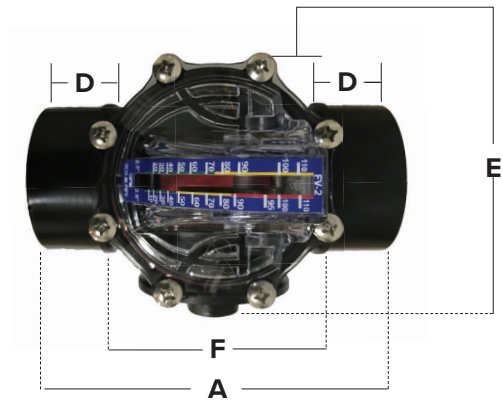
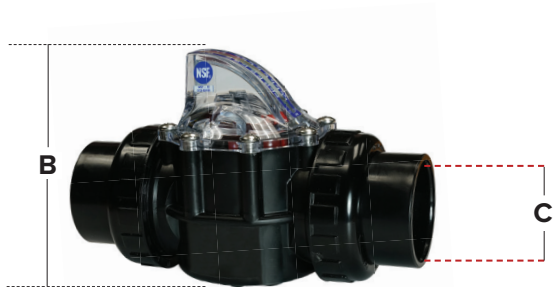
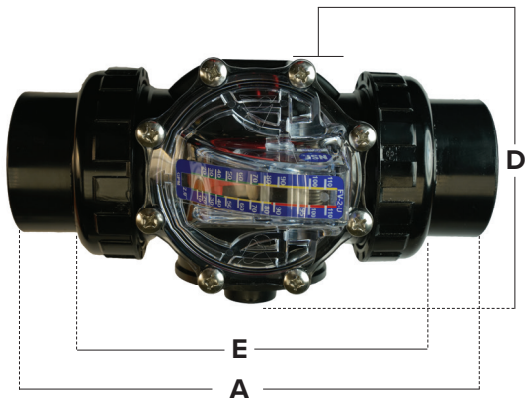

Models: FV-15-U

Reference	Dimension
A	8.24"
B	5.50"
C	Schedule 40 - 1.5" (Slip)
D	4.63"
E	5.81"
WEIGHT	2 lbs.

Models: FV-2-U

Reference	Dimension
A	8.75"
B	5.50"
C	Schedule 40 - 2" (Slip)
D	4.63"
E	5.72"
WEIGHT	2 lbs.

Models: FV-15 / FV-15-L

Reference	Dimension
A	6.5"
B	5.875"
C	Schedule 40 - 1.5"
D	1.375"
E	4.63"
F	3.75"
WEIGHT	1.5 lbs

Models: FV-M-DN40

Refence	Dimension
A	165.1 mm
B	149.23 mm
C	Schedule 40 - DN40
D	34.93 mm
E	117.6 mm
F	92.25 mm
WEIGHT	0.544 kg

Models: FV-2 / FV-2-L / FV-25 / FV-25-L / FV-C-S / FV-C-S-L / FV-C-Saline / FV-C-HF-S

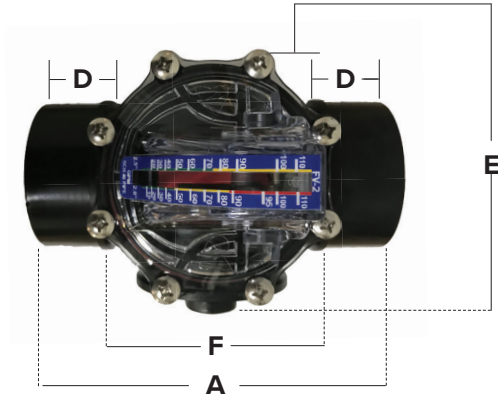

ENGLISH/STANDARD

Reference	Dimension
A	6.5"
B	5.875"
C	Schedule 40 - 2" (Slip) & 2.5" (with coupling)
D	1.375"
E	4.63"
F	3.75"
WEIGHT	1.5 lbs



METRIC

Models: FV-M-DN50 / FV-M-DN65

Reference	Dimension
A	165.1 mm
B	149.23 mm
C	Schedule 40 - DN50 (Slip) / DN65 (with coupling)
D	34.93 mm
E	117.6 mm
F	92.25 mm
WEIGHT	0.544 kg

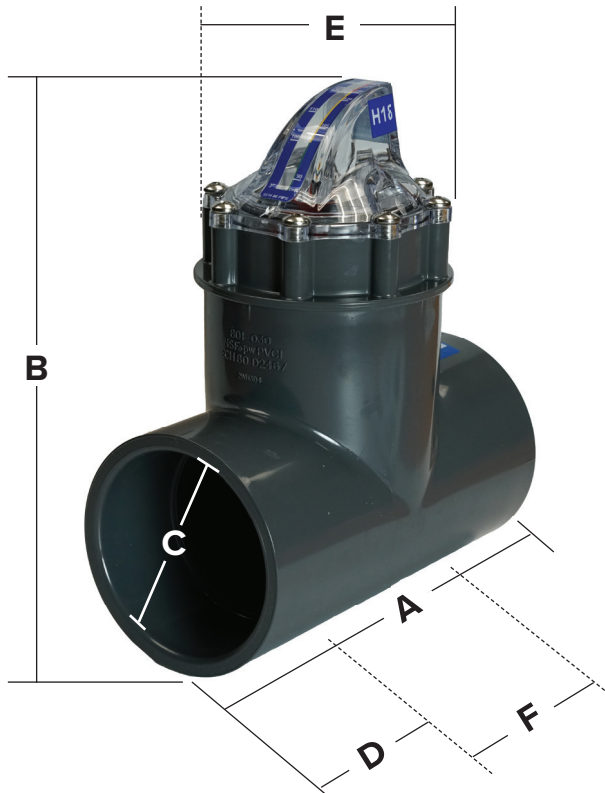

ENGLISH/STANDARD

Models: FV-3 / FV-3-40 / FV-3-L

Reference	Dimension
A	8.0"
B	9.5"
C	Schedule 80 - 3"
D	1.875"
E	4.5"
F	4.25"
WEIGHT	3 lbs

METRIC

Models: FV-M-DN80

Reference	Dimension
A	203.2 mm
B	241.3 mm
C	Schedule 80 - DN80
D	47.63 mm
E	114.3 mm
F	107.96 mm
WEIGHT	1.36 kg

Models: FV-4 / FV-4-L

ENGLISH/STANDARD

Reference	Dimension
A	9.5"
B	9.75"
C	Schedule 80 - 4"
D	2.25"
E	5.25"
F	5.0"
WEIGHT	5 lbs

Models: FV-M-DN100

METRIC

Reference	Dimension
A	241.3 mm
B	247.65 mm
C	Schedule 80 - DN100
D	57.15 mm
E	133.26 mm
F	127.0 mm
WEIGHT	2.27 kg

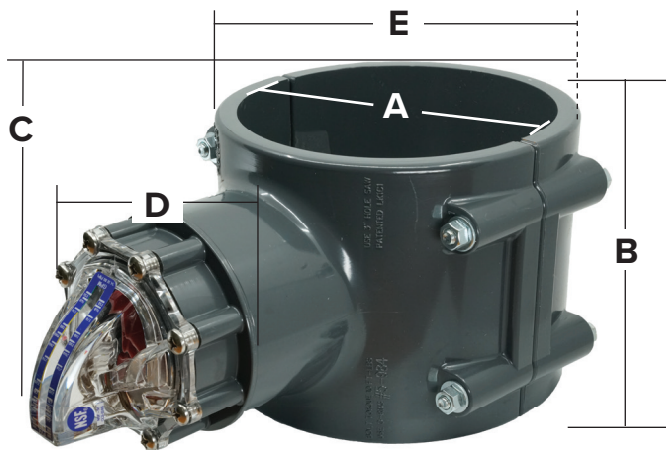
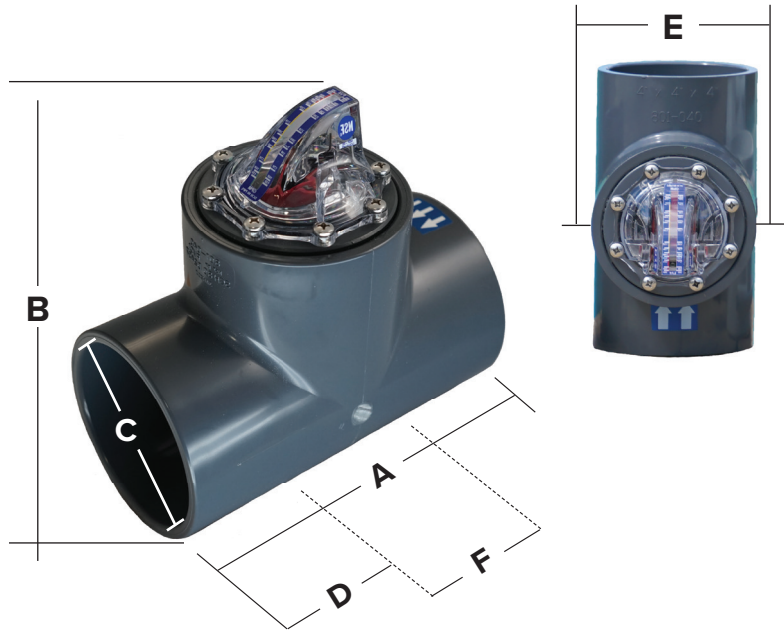

Models: FV-6 / FV-6-L

ENGLISH/STANDARD

Reference	Dimension
A	Schedule 80 - 6.65" (6")
B	6.00"
C	12.53"
D	4.23"
E	7.53"
WEIGHT	5 lbs.

Models: FV-M-DN150

METRIC

Reference	Dimension
A	Schedule 80 - 168.86 mm (DN150)
B	152.65 mm
C	318.45 mm
D	107.51 mm
E	191.32 mm
WEIGHT	2.27 kg

Models: FV-8 / FV-8-L

ENGLISH/STANDARD

Reference	Dimension
A	Schedule 80 - 8.65" (8")
B	8.59"
C	14.37"
D	5.24"
E	9.53"
WEIGHT	5 lbs.

Models: FV-M-DN200

METRIC

Reference	Dimension
A	Schedule 80 - 220 mm (DN200)
B	216 mm
C	368 mm
D	133.11 mm
E	245 mm
WEIGHT	4.08 kg

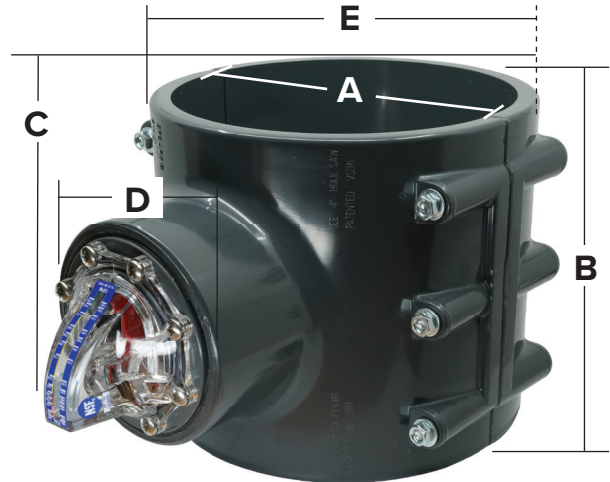

MAINTENANCE

Although FlowVis® is designed to be maintenance-free, periodic checks should be made to the following:

Condition	Check for	Remedy
Leak around lid seal	O-Ring Failure	Replace O-Ring
Leak from lid	Cracks in lid	Order new lid from supplier
Higher flow reading than normal	Broken or weak spring	Replace spring
Lower flow reading than normal	Indicator arm stuck due to debris	Remove lid and clear debris
Flow indicator stuck at one position	Debris between indicator arm and lid	Remove lid and clear debris
Indicator always at max flow when pump running	Broken spring	Replace spring
Flapper seal crinkled	Chlorinator check valve failure	Repair chlorinator, order FlowVis® Service Repair Kit. Consider moving FlowVis® to a different location (see 'Chlorine Feeders' section on pg. 6).

TECHNICAL DATA

Material Data Sheet (MSDS)

Component	FV-15 / FV-15-L	FV-15-U	FV-2 / FV-2-L	FV-2-U	FV-25 / FV-25-L	FV-C-S	FV-3 / FV-3-L	FV-4 / FV-4-L	FV-6 / FV-6-L	FV-8 / FV-8-L	Material
Lid	•	•	•	•	•	•	•	•	•	•	Clear Polycarbonate
Spring	•	•	•	•	•	•	•	•	•	•	Hasteloy c-276
o-ring	•	•	•	•	•	•	•	•	•	•	Viton
Lid Screws	•	•	•	•	•	•	•	•	•	•	316 Stainless Steel
Indicator Pivot Pin	•	•	•	•	•	•	•	•	•	•	Hasteloy c-276
Scale Label	•	•	•	•	•	•	•	•	•	•	Armalex
Product Label	•	•	•	•	•	•	•	•	•	•	Armalex
NSF Label	•	•	•	•	•	•	•	•	•	•	Armalex
Valve Body	•		•		•	•					CPVC
Union Valve Body		•		•							CPVC
Check Valve Flapper	•	•	•	•	•						PPEPS
Flapper Seal	•	•	•	•	•						Viton
Non Check Valve Flapper						•					ABS
Indicator (FV-15 to FV-25)	•	•	•	•	•	•					ABS
Indicator (FV-3 to FV-8)							•	•	•	•	ABS
Magnet	•	•	•	•	•	•	•	•	•	•	N52 Neodymium
Carriage							•	•	•	•	ABS
Flapper Pulley							•	•	•	•	ABS
Spring Pulley							•	•	•	•	ABS and Stainless Steel sleeve
Flapper to Indicator Link							•	•	•	•	ABS
Connecting Wire							•	•	•	•	316 Stainless Steel
Dowel Pin - Link to Indicator							•	•	•	•	316 Stainless Steel
Dowel Pin - Flapper to Carriage							•	•	•	•	316 Stainless Steel
Barrel Bolt - Link to Flapper Binding							•	•	•	•	316 Stainless Steel
Tee, Schedule 80, 3" x 3"							•				CPVC
Tee, Schedule 80, 4" x 4"								•			CPVC
Reducing Bushing 3"							•		•		PVC
Reducing Bushing 4"								•		•	PVC
Saddle Clamp 6" x 3"									•		CPVC
Saddle Clamp 8" x 4"										•	CPVC
Saddle Clamp Nut & Bolt Set									•	•	316 Stainless Steel
Tygon Tubing							•	•	•	•	Tygon

Operational Data

Model	Accuracy	Pressure Rating	Calibration Required?	Min/Max Operating Ambient Temp	Design Life
FV-15, FV-15-L, FV-M-DN40	Average: >98%	50 psi	No	32°F (0°C) / 140°F (60°C)	Greater than 5 years
FV-2, FV-2-L, FV-M-DN50, FV-25, FV-25-L, FV-M-DN65	Average: >98%				
FV-C-S, FV-C-S-L	Average: >98%				
FV-C-Saline	Average: >98%				
FV-3, FV-3-L, FV-M-DN80	Average: >98%				
FV-4, FV-4-L, FV-M-DN100	Average: >98%				
FV-6, FV-6-L, FV-M-DN150	Average: >98%				
FV-8, FV-8-L, FV-M-DN200	Average: >98%				

Straight Pipe Requirements

Model	Straight Pipe Before (x Pipe Diameters)	Straight Pipe After (x Pipe Diameters)
FV-15, FV-15-L, FV-15-U, FV-2, FV-2-L, FV-2-U, FV-25, FV-25-L	0" (x0)	0" (x0)
FV-3, FV-3-40, FV-3-L	15" (x5)	0" (x0)
FV-4, FV-4-L	20" (x5)	0" (x0)
FV-6, FV-6-L	36" (x6)	0" (x0)
FV-8, FV-8-L	64" (x8)	0" (x0)
FV-C-S, FV-C-S-L	0" (x0)	0" (x0)
FV-C-Saline	0" (x0)	0" (x0)

WARRANTY

IMPORTANT, please read and keep this document on record.

1. Definition

H2flow Controls, Inc., warrants the FlowVis® product for 3-years from its date of supply from H2flow Controls, Inc. or its stocking Distributor. In the event that the product experiences a premature failure due to defective workmanship or materials, H2flow will, at its discretion, replace either the failed component(s) or the complete FlowVis unit. H2flow shall not be responsible for third-party labor or any consequential losses. Damage caused by improper installation, misuse or exposure to excessive chemicals such as chlorine, will not be covered by this warranty.

2. Eligibility

This warranty extends to the original purchaser only or to the end-user client of an H2flow Controls Inc authorized affiliate.

3. How to obtain service

To obtain service under the terms of this warranty, the customer is required to notify H2flow Controls Inc. before the expiration of the warranty period and to return the item in accordance with H2flow Controls Inc's product return policy. Any product returned for warranty repair must be accompanied by a full fault report specifying the symptoms and the conditions under which the fault occurs. Should H2flow Controls Inc incur additional cost as a result of a failure to complete the appropriate paperwork, an administrative charge may be levied.

4. Exclusions

This warranty shall not apply to any defect, failure or damage caused by improper use or improper or inadequate care. H2flow Controls Inc. shall not be obligated to provide service under this warranty if:

- a) damage has been caused by a failure to make a full and proper inspection of the product (as described by the documentation enclosed with the product at the time of shipment) on initial receipt of the product following shipment;
- b) damage has been caused by the attempts of individuals, other than H2flow Controls Inc staff to repair or service the product;
- c) damage has been caused by the improper use of the product, including but not limited to, the installation of a FlowVis® unit using a chlorination system as described on page 4 of this manual.

5. Charges

Under cover of this warranty, H2flow Controls Inc will pay the carriage and insurance charges for the shipment of defective product back to H2flow Controls Inc and for its return to the client's original site of dispatch except when:

- a) H2flow Controls Inc's product return policy has not been followed.
- b) product failure is caused by any of the exclusions described at paragraph 4 above, when the customer will be liable for the full cost of the repair (parts and labor) plus all carriage and insurance costs to and from H2flow Controls Inc's premises.
- c) the product is damaged in transit and a contributory cause is inadequate packaging. It is the customer's responsibility to ensure that the packaging used to return equipment to H2flow Controls Inc is the same, or has equivalent protective qualities, to that used to ship the product to the customer in the first instance. Any damage resulting from the use of inadequate packaging will nullify H2flow Controls Inc's obligations under this warranty.

Should the customer's product be damaged in transit following a repair at H2flow Controls Inc's site, a full photographic record of the damage must be obtained (packaging and the product) to support any claim for recompense. Failure to present this evidence may limit H2flow Controls Inc's obligations under this warranty.

THIS WARRANTY IS GIVEN BY H2FLOW CONTROLS INC IN LIEU OF ANY OTHER WARRANTIES, EXPRESSED OR IMPLIED, INCLUDING BUT NOT LIMITED TO ANY IMPLIED WARRANTY OF MERCHANTABILITY, NON INFRINGEMENT OR FITNESS FOR A PARTICULAR PURPOSE. H2FLOW CONTROLS INC SHALL NOT BE LIABLE FOR ANY SPECIAL, INDIRECT, INCIDENTAL OR CONSEQUENTIAL DAMAGES OR LOSSES. WE SPECIFICALLY DISCLAIM ANY AND ALL WARRANTIES TO CUSTOMERS OF THE CUSTOMER. THE CUSTOMER'S SOLE REMEDY FOR ANY BREACH OF WARRANTY IS THE REPAIR OR REPLACEMENT, AT H2FLOW CONTROLS INC'S DISCRETION, OF THE FAILED PRODUCT.



H2flow Controls, Inc., 3545 Silica Road, Unit F, Sylvania, OH 43560 U.S.A.
Tel: 888-635-0296 (Toll Free) OR (+1) 419-841-7774 (International) • Fax: 419-517-9900
For international sales and service, please visit our website: www.h2flow.net