

# GLOBAL LIFT CORP



**Owner's Manual**

**Rotational Series**

**R-375**



684 N Port Crescent Rd  
Suite C

Bad Axe, MI 48413

Toll Free: 866-712-0606

Fax: 989-269-5902

[www.globalliftcorp.com](http://www.globalliftcorp.com)



*ROTATIONAL SERIES POOL LIFTS*

*R-375*

*TABLE OF CONTENTS*

<b>INTRODUCTION</b>	<b>PAGE – 3</b>
<b>ADA GUIDELINES FOR PLACEMENT</b>	<b>PAGE – 4</b>
<b>24 VOLT BATTERY SYSTEM/WITH CONTROLS</b>	<b>PAGE – 5</b>
<b>ROTATIONAL SERIES OPERATING INSTRUCTIONS</b>	<b>PAGE – 6</b>
<b>UNIT MAINTENANCE AND CARE</b>	<b>PAGE – 7</b>
<b>TROUBLESHOOTING</b>	<b>PAGE – 8</b>
<b>TROUBLESHOOTING FLOW CHART</b>	
<b>WARRANTY INFORMATION</b>	<b>PAGE – 9/10/11</b>
<b>WARRANTY REGISTRATION</b>	<b>PAGE - 12</b>
<b>NEW CONSTRUCTION/SLEEVE CUT INSTALLATION R-375</b>	
<b>RETRO FIT INSTALLATION R-375</b>	
<b>FIXED ANCHOR INSTALLATION R-375</b>	
<b>OUT OF BOX INSTALLATION</b>	
<b>SEAT INSTALLATION</b>	



## **INTRODUCTION**

# **Your Number One Choice for Commercial Pool Access Equipment**

Global Lift Corp. is located in Mid-Michigan, Global Lift Corp. prides itself in manufacturing top of line quality aquatic access equipment. Global Lift Corp's key staff has a century of combined industry experience and we take pride in each and every product that we build. Our Company is ISO Certified and our products are manufactured in the United States. Global Lift Corp uses only the finest materials and processes to provide our customers with the highest quality products while still maintaining a price competitive edge.

## ADA GUIDELINES FOR POOL LIFT PLACEMENT

1. Pool Lift Location. Pool lifts shall be located where the water level does not exceed 48 inches (1220 mm).
2. Seat Location. In the raised position, the centerline of the seat shall be located over the deck and 16 inches (405 mm) minimum from the edge of the pool. The deck surface between the centerline of the seat and the pool edge shall have a slope not steeper than 1:48.

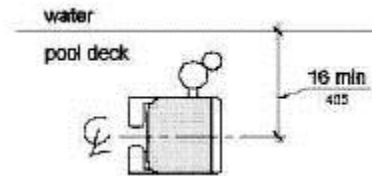

3. Clear Deck Space. On the side of the seat opposite the water, a clear deck space shall be provided parallel with the seat. The space shall be 36 inches (915 mm) wide minimum and shall extend forward 48 inches (1220 mm) minimum from a line located 12 inches (305 mm) behind the rear edge of the seat. The clear deck space shall have a slope not steeper than 1:48.

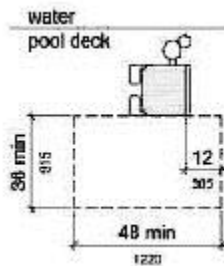

4. Submerged Depth. The lift shall be designed so that the seat will submerge to a water depth of 18 inches (455 mm) minimum below the stationary water level. To make sure the lift has enough clearance the lift should be installed at a location with 48" of Water depth

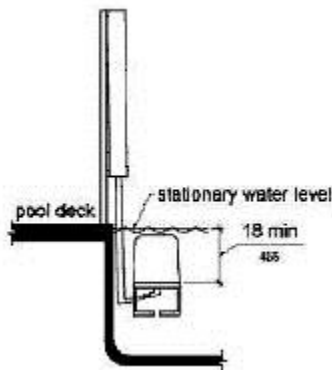

## *24 VOLT BATTERY SYSTEMS WITH CONTROLS*

All of Global Lift Corp's Rotational Series Lifts are equipped with a sealed 24 volt battery that is rechargeable. Along with a charging unit, hand held controller and control compartment. The 24 volt battery mounts into the control compartment and the battery simply snaps in. The battery should be charged for 5-8 hours prior to the 1<sup>st</sup> use. There is a red emergency stop button on top of the control unit. Turn this clockwise to the right to ensure it is in the unlocked position.

The unit is operated by the 4 button easy to use controls. The arrow pointing down will lower the lift when depressed, the arrow that points up will raise the unit when depressed and the bottom arrows will rotate the lift from left to right. If you hear the low battery indicator tone "Do Not Use the Lift". Proceed to remove the battery from the unit and place battery on the charging unit.

### RECHARGING THE BATTERY:

Remove battery from the unit by unclipping from the control compartment. Place the battery in the charging unit.

When the battery is placed on the charger the light will change to "Red" to indicate it is charging. Once the light turns to "Green" the charger is indicating that the battery is fully charged and is ready for use in your Rotational Series pool lift.



## *ROTATIONAL SERIES POOL LIFT OPERATING INSTRUCTIONS*

Prior to using the Rotational Series Pool Lift, perform a test run of the lift empty. Once that is completed and the lift is back to original position, make sure that the arm lifts are in the up position and the seatbelt is unbuckled, once acknowledged you are ready!

Once you are in the seat, buckle the seatbelt (make sure it is snug) and lower the arm rails. Before you attempt to operate the lift, make sure the pathway is clear from any obstacles.

Once you have the 4 button easy controls in your hand, press the Left or Right arrow that specifies which direction you want the lift to move in, once over the water press the down arrow to lower the lift into the pool, keep in mind you don't have to go to the bottom of the cycle, you can stop the lift whenever you deem comfortable to exit the lift. However when exiting the pool while on the lift, you should complete the cycle back to the top to have a completely safe exit from the pool.

Once submerged into the pool, unbuckle the seatbelt and raise the armrest and slide off of the seat. Once you are done with your pool activity, make sure the seat is lowered sufficiently to allow you too easily slide back into the chair. Once you are seated, buckle the seatbelt and make sure that it is snug, lower the armrest.

Next, to raise the lift chair out of the pool, make sure you press the button/arrow that represents up on the control. Apply continuous pressure until the lift comes to a complete stop at the end of the complete up cycle and then press the left or right arrow to return to the pool deck. You now can unbuckle the seatbelt and raise the arm rest and exit the unit.



# Maintenance

Regular servicing will help prolong the life of your lift. Routine maintenance and cleaning is very important. The following is a routine maintenance you should follow.

## Daily

- Check and charge battery
- Test for normal operations
- Inspect your lift
- Clean and dry the lift and seat with clean water
- Cover lift after use

## Weekly

- Overview Daily Checklist
- Wipe away any surface rust with household spray cleaner
- Clean tough stains with a Scotch brite pad and wipe clean
- Cycle the lift to keep all parts moving freely

## Monthly

- Inspects all connections, frame, seat etc,
- Clean battery and controller connections
- Clean metallic surfaces with a wax cleaner

The maintenance provision of the ADA states that "a public accommodation shall maintain in operable working condition those features of facilities and equipment that are required to be readily accessible to and usable by persons with disabilities"



## *TROUBLESHOOTING GUIDE*

Before any troubleshooting commences make sure the battery has a full charge!

(1) Does the lift raise or lower

NO

- (a) Check the battery connection and reconnect
- (b) Check hand controls, make sure they are connected properly
- (c) Check for any loose wires on the control compartment
- (d) Check the connection cable for damage
- (e) Check to see that the lock on top of the control unit is turned clockwise and in the unlocked position
- (f) Check the battery with a volt meter to determine if the battery has at least 24 volts.

(2) The batteries will not charge?

Yes

- (a) Battery not inserted adequately, re-insert battery and check position
- (b) Check the Display light – Is it red to indicate charging.
- (c) Check the main cable for damage.
- (d) Subsequent charging can be restarted by briefly disconnecting the main supply or the battery.





## Global Lift Corp Warranty Information

The **Commercial**, **Proformance**, and **Rotational** series lifts have a **Lifetime Limited Warranty** on the metal components of the frame, not including the powder coating process. The **Superior** series lift has a 5 year structural limited warranty. Global Lift Corp warrants to the original retail end user only products manufactured by Global Lift Corp, when properly installed in accordance to the assembly and installation instructions, and when the equipment is properly *used and maintained*, be free from material defects and workmanship as stated below:

- Warranty starts from date of original purchase
- Metal structure (not including powder coat) – Lifetime Limited **(Commercial/Proformance/Rotational Series)**
- Metal structure (not including powder coat) 5 year limited structural warranty **(Superior Series)**
- Actuator and controls – 2 years from date of purchase then 2 years prorated
- Actuator and controls – 3 years 50% coverage (Customer is responsible for 50% of replacement cost)
- Actuator and controls – 4 years 30% coverage (Customer is responsible for 70% of replacement cost)
- Battery – 1 year from date of purchase

*This warranty does not cover damages to **ANY** of our lifts due to accident, abuse, negligence, misuse, damage by improper use of chemicals, fading, ice damage, fire, rust beyond structural damage( does not cover cosmetic rust), exceeding the weight capacity for model purchased, failure to install or to assemble the product in accordance with the installation and assembly instructions, normal wear and tear from day to day use, not maintained properly, if unit is altered or repaired without written approval of Global Lift Corp – All Warranties are Void.*

To commence the warranty claim process of a Global Lift Corp product, in writing provide place of purchase along with the product name and description, date of installation and a detailed description of the defect, along with a photo of the entire product and claimed defect. Prior to a 30 day period after receiving the written warranty claim by Global Lift Corp and barring any unforeseen delays the claimant will be notified of Global Lift Corp's decision regarding the claim.

If the request made by Global Lift Corp for the product to be returned to its factory or distributor of choice for inspection and/or repair, purchaser will be liable for "Freight Prepaid". Global Lift Corp at its option will replace or repair the defective item and deliver the repaired product or replacement to the buyer of the product, freight prepaid by the purchaser to the destination on file in regards to the original order. Parts and Products returned for replacement to Global Lift Corp shall remain the property of Global Lift Corp under this limited warranty.

A new warranty period shall not be established for any repaired or replaced products. Replaced or repaired products will remain under warranty only for the remainder of the original warranty period for the original product purchased. No person or organization is authorized to make any other specific or implied warranties on behalf of Global Lift Corp.

THE WARRANTIES ARE IN LIEU OF ALL OTHER WARRANTIES, EXPRESSED OR IMPLIED, WHICH ARE HEREBY DISCLAIMED AND EXCLUDED, INCLUDING WITHOUT LIMITATION ANY WARRANTY OF MERCHANTABILITY OR FITNESS FOR A PARTICULAR PURPOSE OR USE.

IN NO EVENT SHALL GLOBAL LIFT CORP BE LIABLE FOR ANY INCIDENTAL, CONSEQUENTIAL, INDIRECT, SPECIAL EXEMPLARY OR PUNITIVE DAMAGES OR LOST PROFITS FROM ANY BREACH OF THIS LIMITED WARRANTY. THE SOLE AND EXCLUSIVE REMEDY OF THIS WARRANTY IN REGARDS TO GLOBAL LIFT CORP'S PRODUCT SHALL BE LIMITED TO REPLACEMENT OR REPAIR AT A GLOBAL LIFT CORP'S FACILITY OR A DULY APPOINTED DISTRIBUTOR'S LOCATION OR AT A GLOBAL LIFT CORP'S DESIGNATED LOCATION. IN NO EVENT SHALL GLOBAL LIFT CORP LIABILITY EXCEED THE ENTIRE AMOUNT PAID TO GLOBAL LIFT CORP BY THE ORIGINAL PURCHASER IN REGARDS TO THE DEFECTIVE OR FAILED PRODUCT.

NO REPRESENTATIVE OF GLOBAL LIFT CORP SUCH AS AGENTS, DISTRIBUTORS AND DEALERS HAS THE AUTHORITY TO ALTER IN ANY FASHION THE TERMS OF THIS WARRANTY AND GLOBAL LIFT CORP IS "NOT" RESPONSIBLE FOR REPRESENTATION, UNDERTAKING OR WARRANTY MADE BY ANY OTHER PERSON BEYOND THE WARRANTIES EXPRESSED SET FORTH IN THIS WARRANTY.

## Warranty Procedure

**Warranty Claims** shall be submitted to Global Lift Corporation by the distributor which originated the sale with Global Lift Corporation or directly to Global Lift Corporation.

All RGA (Return Goods Authorization) documents shall be requested by and issued only to the distributor which originated the sale or directly to Global Lift Corporation.

Global Lift Corporation shall determine warranty coverage validation and replacement parts or repair, which were directed to the distributor which originated the sale or that are initiated directly with Global Lift Corporation.

Warranty claims received from end users by Global Lift Corporation shall be re-directed to the distributor which originated the sale with Global Lift Corporation or processed directly by Global Lift Corporation.



**GLOBAL LIFT CORP  
WARRANTY REGISTRATION  
PURCHASED BY:**

Company Name: \_\_\_\_\_

Contact: \_\_\_\_\_

City: \_\_\_\_\_ State: \_\_\_\_\_ Zip: \_\_\_\_\_

Phone: (\_\_\_\_\_) \_\_\_\_\_

**DEALER:**

Name: \_\_\_\_\_ Phone Number \_\_\_\_\_

City: \_\_\_\_\_ State: \_\_\_\_\_ Zip: \_\_\_\_\_

Phone: (\_\_\_\_\_) \_\_\_\_\_

Model: \_\_\_\_\_ Serial Number: \_\_\_\_\_

Color: \_\_\_\_\_ Purchase Price: \$ \_\_\_\_\_ Date Purchased: \_\_\_\_\_

I have read and I accept the warranty terms.

Signature: \_\_\_\_\_ Date: \_\_\_\_\_

This card must be completed and returned to Global Lift Corp within 30 days of purchase date to assure coverage.

**Please mail to: Global Lift Corp, 684 N Port Crescent Suite C, Bad Axe, MI 48413**

# ROTATIONAL SERIES R-375 LIFT NEW CONSTRUCTION & SAW CUT SLEEVE ANCHORING SYSTEM INSTALLATION MANUAL



Prior to installing, please make sure you have filled out a Deck Configuration Form to make sure you have the correct lift that fits Your application.



# ROTATIONAL SERIES R-375 SLEEVE ANCHORING SYSTEM INSTALLATION

## PARTS LIST

- ✓ 1 - Anchor Sleeve w/ Base
- ✓ 1 - Plastic Cap
- ✓ 1 – Binding Screw



# ANCHORING SLEEVE, BASE PLATE & BINDING SCREW R-375



November 2013

New Construction/Saw Cut Sleeve  
Anchor R-375



# ADA GUIDELINES FOR POOL LIFT PLACEMENT

- Pool Lift Location. Pool lifts shall be located where the water level does not exceed 48 inches (1220 mm).  
Seat Location. In the raised position, the centerline of the seat shall be located over the deck and 16 inches (405 mm) minimum from the edge of the pool. The deck surface between the centerline of the seat and the pool edge shall have a slope not steeper than 1:48.

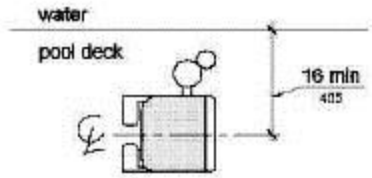

- Clear Deck Space. On the side of the seat opposite the water, a clear deck space shall be provided parallel with the seat. The space shall be 36 inches (915 mm) wide minimum and shall extend forward 48 inches (1220 mm) minimum from a line located 12 inches (305 mm) behind the rear edge of the seat. The clear deck space shall have a slope not steeper than 1:48.

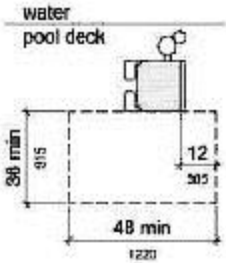

- Submerged Depth. The lift shall be designed so that the seat will submerge to a water depth of 18 inches (455 mm) minimum below the stationary water level.

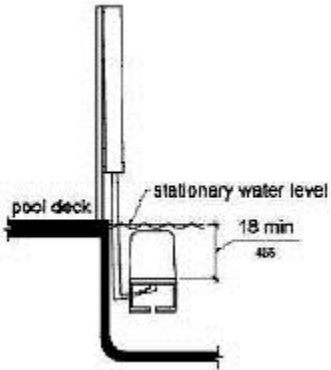



# ROTATIONAL SERIES – SLEEVE ANCHORING SYSTEM

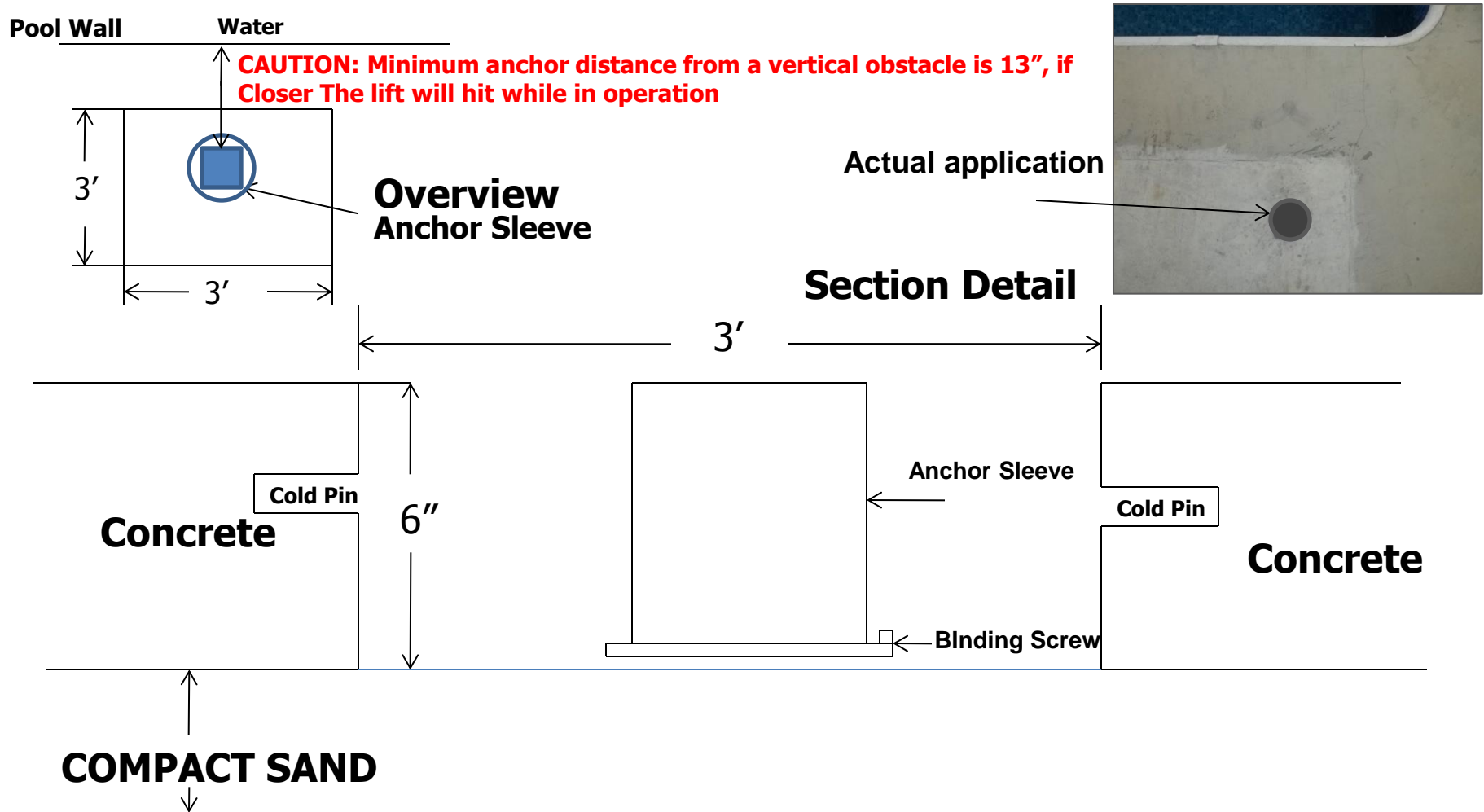

Front of Anchor Sleeve must be 12" to 36" from the water's edge or 13" min if an obstacle is present before the water. Connect the binding screw to your bonding grid

Cold Pin's should be 1/2" rebar 6" to 8" long

**NOTE: Make sure your anchor sleeve is level and square with your pool's edge.**

## INSTALLATION STEPS

Step 1: Determine the location for installation (Make sure all ADA requirements are met)

\*\*\*NOTE: The installation of Global Lift Corp's anchor system's are a guideline of minimum requirements. In some states or municipalities they may require additional steps due to their local codes or ordinances.\*\*\*

Step 2: Make sure that all the parts are present (Refer to the parts list)

- ✓ 1 - Anchor Sleeve w/ Base
- ✓ 1 - Binding Screw
- ✓ 1 - Plastic Cap

Step 3: At the determined location for installation, chalk out a 3' X 3' area prior to cutting out the concrete. (Refer to overview, the front end of the Anchor Sleeve must be 12" to 36" from the water's edge or 13" min if an obstacle is present before the water and 6" deep). New Construction, the concrete must be 6" deep with a 1/2" reinforcing rod, minimum of an 18" grid.

**NOTE: Make sure you comply with all local codes and ordinances.**

Step 4: Once the 3' X 3' area is cut out, make sure you drill in the inner wall of all 4 sides of the area (refer to the section detail) for the purpose of cold pinning the new concrete to the old concrete. Use 1/2" rebar, 6" to 8" in length.

Step 5: Place the Anchor Sleeve in the cut out area, make sure that the front of the Anchor Sleeve is 12" (min) to 36" (max) from the water's edge or 13" min if an obstacle is present before the water. (refer to overview) A key element is to make sure that the Anchor Sleeve is level and square with the pool so that your Rotational Series Lift sits properly on the deck.

**NOTE: If you place the anchor sleeve 12" from the pools edge, the lift will reach 36" out into the water. If you were to place the anchor sleeve 36" from the pools edge or an obstacle, the lift will only reach 12" into the water.**

Step 7: Bonding the unit – The binding screw is supplied with the Anchor Sleeve, locate the binding screw, connect the binding screw to the bonding grid.

**NOTE: Make sure you comply to all local codes and ordinances.**

Step 8: Pour in your concrete, (make sure you cover the hole on your anchor sleeve with the plastic cap provided, so you don't get concrete in the sleeve) a minimum of 4,000 psi concrete with reinforcing rod. Also make sure that the top of the anchor sleeve is flush with the deck. Before you install your lift make sure you let the concrete set up for 48 hours.

Step 9: After the concrete has set for 48 hours, now it's time to install your lift. Place your Rotational Series Lift over the anchor sleeve, once you have completed the installation, please refer to User's Manual for a safe operation.

# ROTATIONAL SERIES R-375 LIFT RETRO-FIT SLEEVE ANCHORING METHOD INSTALLATION MANUAL



Prior to installing, please make sure you have filled out a Deck Configuration Form to make sure you have the correct lift that fits Your application.

# RETRO-FIT SLEEVE ANCHORING METHOD

## R-375

### ROTATIONAL SERIES LIFT

## PACKING LIST

- 1 – Anchor Sleeve w/ Base
- 1 – Plastic Cap
- 1 – Binding Screw

# ADA GUIDELINES FOR POOL LIFT PLACEMENT

- Pool Lift Location. Pool lifts shall be located where the water level does not exceed 48 inches (1220 mm).  
Seat Location. In the raised position, the centerline of the seat shall be located over the deck and 16 inches (405 mm) minimum from the edge of the pool. The deck surface between the centerline of the seat and the pool edge shall have a slope not steeper than 1:48.

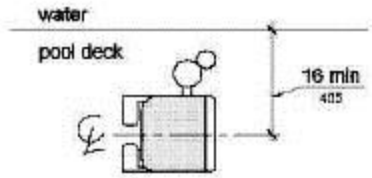

- Clear Deck Space. On the side of the seat opposite the water, a clear deck space shall be provided parallel with the seat. The space shall be 36 inches (915 mm) wide minimum and shall extend forward 48 inches (1220 mm) minimum from a line located 12 inches (305 mm) behind the rear edge of the seat. The clear deck space shall have a slope not steeper than 1:48.

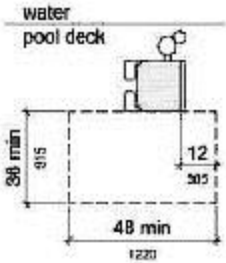

- Submerged Depth. The lift shall be designed so that the seat will submerge to a water depth of 18 inches (455 mm) minimum below the stationary water level.

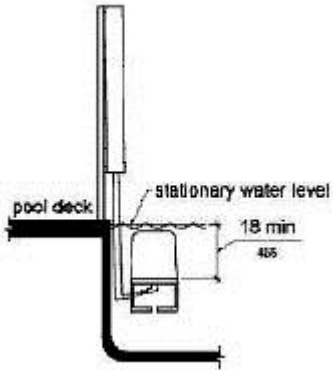

## R-375

**CAUTION: Minimum anchor distance from a vertical obstacle is 13", if Closer The lift will hit while in operation**



Picture A

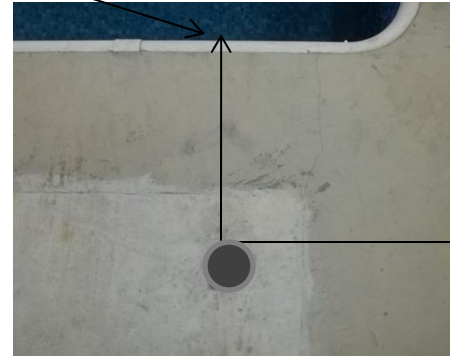

Front Edge of  
Anchor Sleeve

Picture B

**STEP 1:** Locate the retro-fit anchoring sleeve (as shown above) picture A

- Once you determine where your lift is going to be located at your pool, place the anchor sleeve down so you can mark a circle around the base on the concrete where you will need to drill the hole. NOTE: From the pools edge or if an obstacle is present before the water the minimum distance is 12" and the maximum is 36" from the front of the anchor sleeve. See picture B

**\*\*\*NOTE:** The installation of Global Lift Corp's anchor system's are a guideline of minimum requirements. In some states or municipalities they may require additional steps due to their local codes or ordinances.\*\*\*

## R-375

Front edge of anchor sleeve or an Obstacle



Measure Distance to make Sure It's 12" minimum and 36" maximum from the Water's edge or if an obstacle is present before the water

Picture A

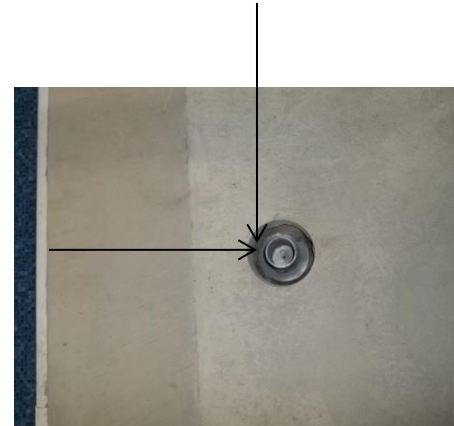

Picture B

**Step 2:** You will need a 5" diameter core drilling bit.

- Make sure you have accurately marked your hole location to be drilled. After drilling your hole (picture A), it must be 6" deep and flat on the bottom of the hole (shown above). Also double check your measurements they should be: Place your anchor sleeve in the hole and make sure the front edge of the sleeve is in between 12" minimum distance and 36" maximum distance from pools edge or 13" min if an obstacle is present before the water. (picture B) Then connect the binding screw to the bonding grid. Please check your local codes and ordinances are met.



## R-375



### **STEP 3** : Cementing the anchor sleeve in the concrete.

- You will need 10 lbs of Quick dry Anchoring Cement (Commercial Grade Quikrete Exterior Use Anchoring Cement) to complete the installation. You can purchase at any hardware store in your area. Read the label and follow manufacturer's instructions.
- Start pouring into the hole evenly until you fill it up, make sure not to overfill the hole so that it does not create more work to scrap excess concrete off.
- Let the concrete set for 24hrs, sand stone to smooth the finish. Make sure the anchor sleeve is flush with the concrete
- You are now ready to install your Rotational Series Lift.

## Fixed Anchor Rotational Series R-375



Locate the drop in anchor (shown above)

Place Lift into Anchor and position so anchoring hole is in the desired position.

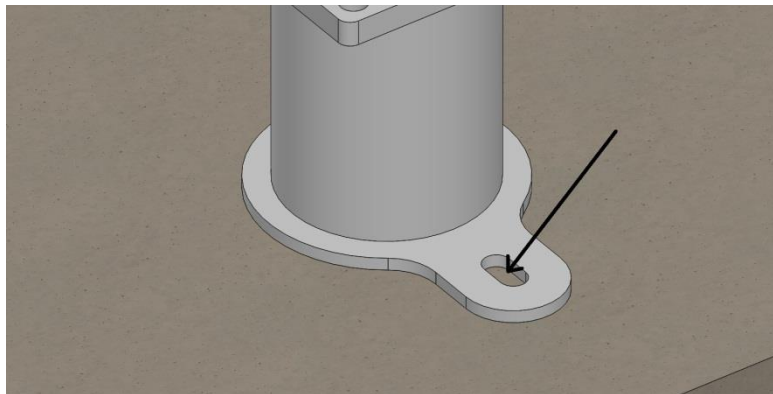

Now mark the concrete so you will know where to drill (the hole should be centered in the slot).

### Fixed Anchor Installation Instructions

1. Always wear safety goggles.
2. Follow the drill manufacturer's safety instructions.

3. Use only solid carbide-tipped bits meeting the ANSI B94-12 tip diameter (Use 5/8 dia drill bit).
4. Drill the hole perpendicular to the work surface. To assure full holding power do not ream the hole or allow the drill to wobble.
5. Drill the whole as deep as full length of anchor (2" deep) but not closer that two anchor diameters to the bottom (opposite surface of the concrete).
6. Clean the hole using compressed air and a wired brush. A clean hole is necessary for proper performance.
7. Drop anchor in hole and tap flush with surface (anchor can be set flush with base material or sub-set)
8. Using setting tool; set the drop in with several sharp hammer blows until expansion plug bottoms out in hole.



Setting tool shown

9. Position the lift and align hole in base.
10. Insert bolt and tighten

# ROUND SLEEVE ANCHOR – PAVER INSTALLATION OPTION 1

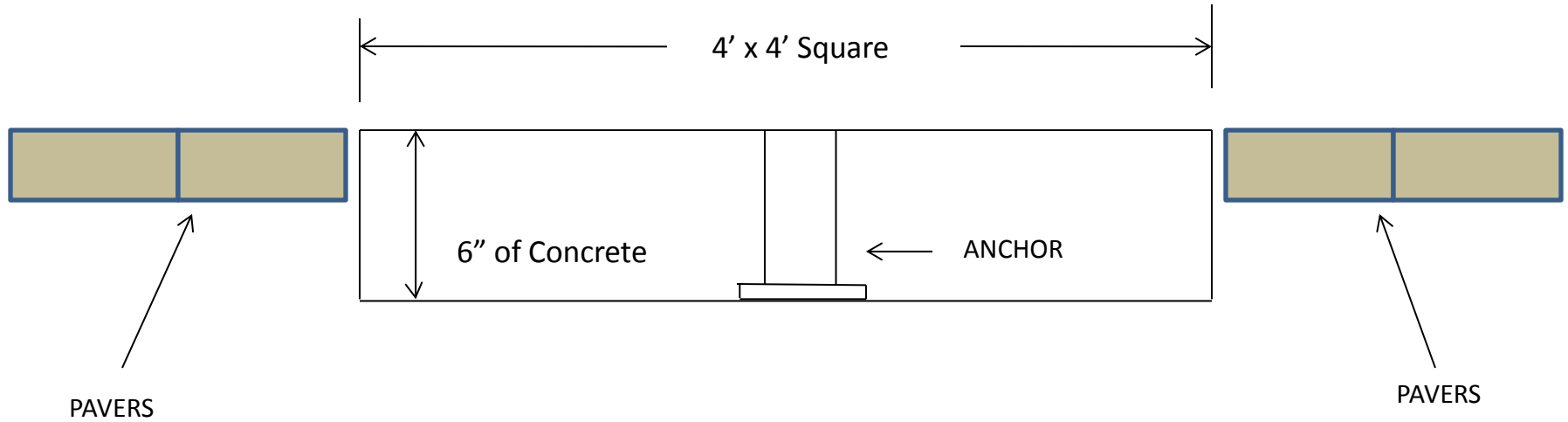

Please follow Anchor Instructions for Installation

## ROUND SLEEVE ANCHOR – PAVER INSTALLATION OPTION 2

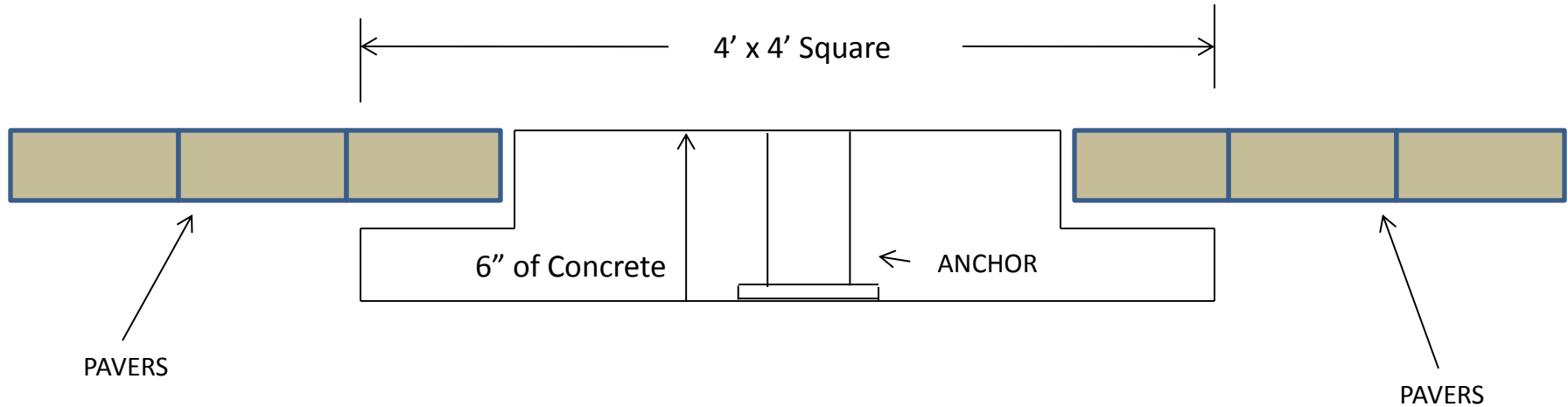

**Option #2** same as Option 1, just recess the concrete down and reinstall the pavers over the concrete except directly under the pool lift, That section needs to remain concrete!

Please follow Anchor Instructions for Installation

# OVERVIEW ROUND SLEEVE ANCHOR – Paver Option OPTION 1

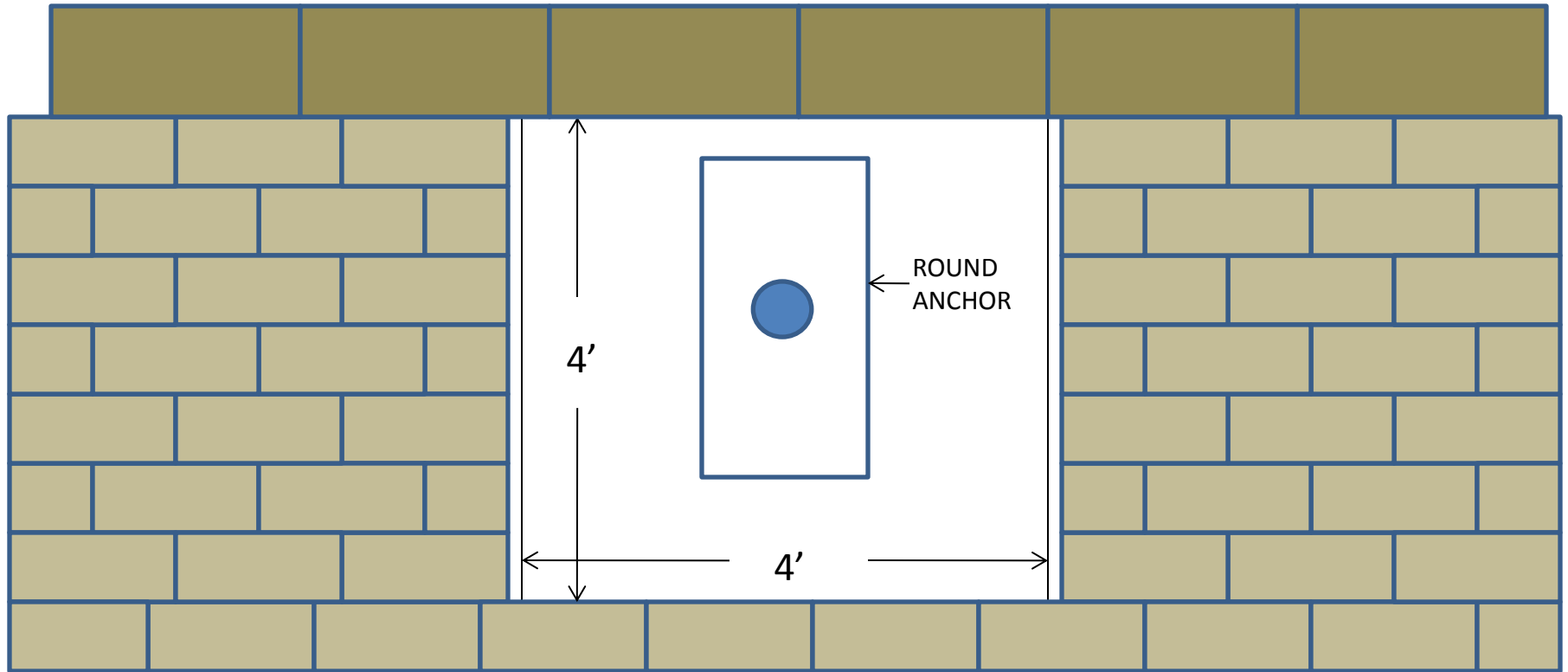

# OVERVIEW ROUND SLEEVE ANCHOR – Paver Option OPTION 2

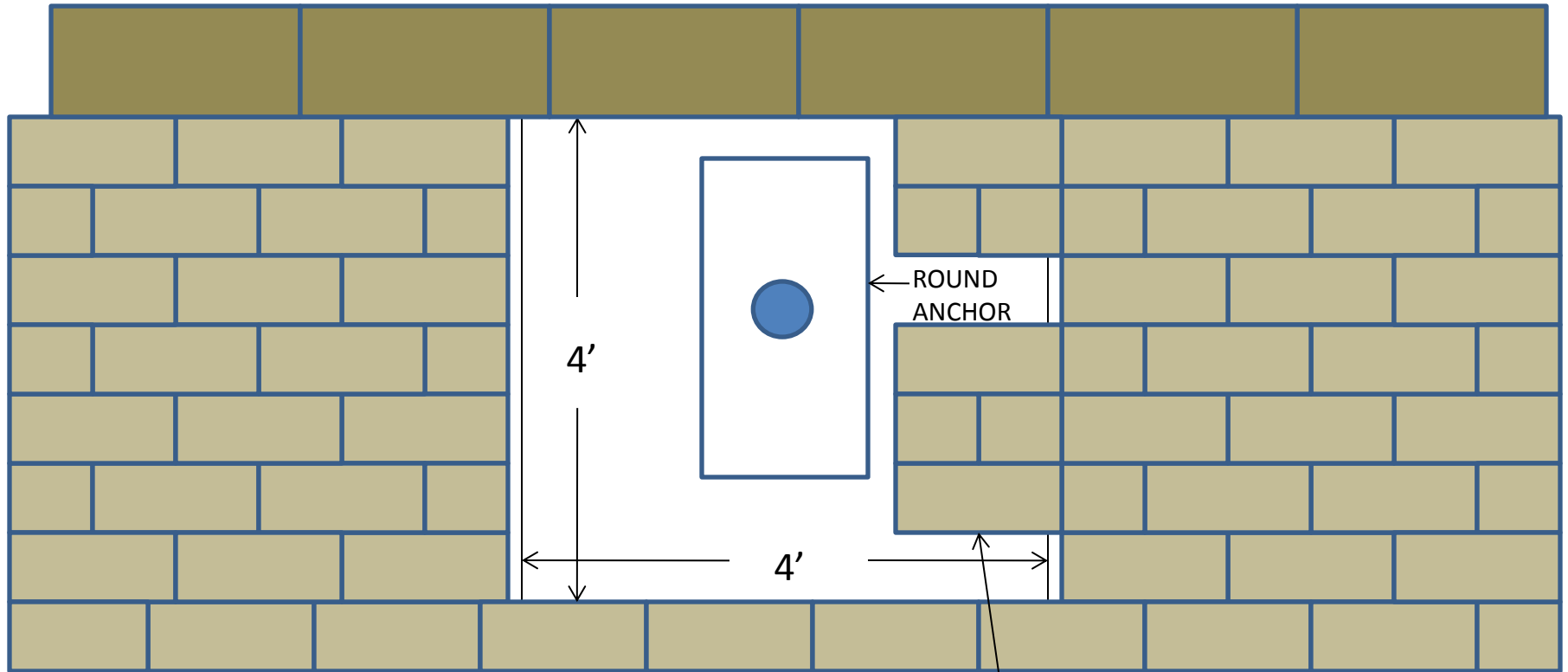

**Option #2** same as Option 1, just recess the concrete down and reinstall the pavers over the concrete except directly under the lift, That section needs to be concrete

# GLOBAL LIFT CORP INSTALLATION MANUAL (Out of Box) R-Series Lifts Series Lifts





# GLOBAL LIFT CORP INSTALLATION MANUAL (Out of Box)

## PARTS LIST

- 1 Part A – Main Unit with Motor
- 1 Part B – Horizontal Dual Bar Beam
- 1 Part C – Seat Bar
- 1 Part D - Seat
- 1 Part E – Foot Rest

## Tools Needed:

- (2) ½ inch wrench
- (2) 9/16 inch wrench
- (2) ¾ inch wrench
- (1) Rubber Mallet



# INSTALLATION STEPS



Picture 1

Step 1:

Unpack your items (picture 1). Loose Items will consist of:

- Part A Main Beam with Motor
- Part B Horizontal Dual Bar Assembly
- Part C Seat Bar
- Part D Seat
- Part E Foot Rest and Tube
- 3 - 5/16" x 3" Bolt with Lock nut

# INSTALLATION STEPS



Picture 2



Picture 3

Step 2:

Insert Main Beam with Motor Into the Anchor Sleeve Picture 2  
(Sleeve Anchor Pre-Installed Prior to Installation)

Step 3:

Attach Part B to Part A by removing bolts from Part B (which are already inserted). Attach Part B to Part A and tighten bolts (DO NOT OVERTIGHTEN) All bolts need to be tightened to approximately 20 lbs. of torque at end of assembly. Picture 3.

# INSTALLATION STEPS



Picture 4



Picture 5

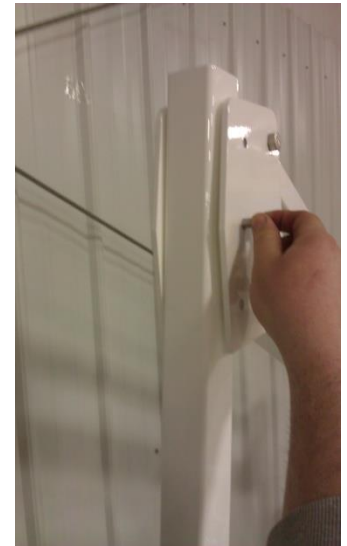

Picture 6

Step 4:

Attach actuator to Part B beam into the actuator holder location. Picture 4.

Step 5:

Attach Part B beam to the Part C seat bar tube using the bolts that are in the tube Picture 5 & Picture 6.

Step 6:

Continue to seat assembly instructions.



# GLOBAL LIFT CORP CUSTOM SEAT INSTALLATION MANUAL R-Series Lifts Series Lifts



# GLOBAL LIFT CORP

## CUSTOM SEAT INSTALLATION MANUAL

### PARTS LIST

- 1 - Seat
- 1 - Foot Rest
- 2 – Arm Rests
- 1 - Seat Belt & Buckle
- 3 – 5/16 x 3” Attaching Pin with lock nut
- 1 – 5/16 x 2” Foot Rest attaching bolt w/ nut
- 1 – 2” Round cap
- 1 – 1” Round cap



# INSTALLATION STEPS



Picture A

Step 1:

Unpack your custom seat (picture A). Loose Items will consist of:

- Foot Rest and Tube
- 3 - 5/16" x 3" Bolt with Lock nut

# INSTALLATION STEPS



Picture A



Picture B

Step 2:

Align your custom seat (Picture A), With 3 pre-drilled holes as shown.

Step 3:

Once you have the seat in place, take one 5/6" x 3" bolt and slide it through the pre-drilled Holes (Picture B). Once you have inserted the bolt all the way through, apply the locking nut (supplied) and tighten down.



# INSTALLATION STEPS



Step 4:

Locate the other 2- 5/16 x 3" securing bolts (supplied), insert the bolt through the pre-drilled Seat and tube holes (As shown Above). Once you have the bolts inserted, secure the installation With the lock nuts that are provided and tighten down.



# INSTALLATION STEPS

## FOOT REST



Picture A



Picture B

### Step 5:

In picture A, slide the foot tube through the foot rest sleeve and line the hole to the Slot. In picture B, locate the 5/16" x 2" bolt and insert into the pre-drilled holes to secure the foot rest to the lift. Place the lock nut on the bolt and tighten down. Once that is complete, you are ready to enjoy your Global Lift Corp pool lift.