

ELP HO HDPE RANGE



INSTALLATION AND MAINTENANCE MANUAL



CERTIFICATIONS

The Delta UV ELP range of Ultraviolet Sanitation Systems for pools, spas, water features and ponds are certified and listed by the following independent laboratories and authorities. Certifications can be independently confirmed by visiting the specific websites shown with each certification below:

- Listed under UL standard UL1081/UL1563 –US
- **Certified To Canadian CAN/CSA Standard C22.2 No. 218.1**
 - MET Listing # E113005
 - <http://www.MET.com>
- **Certified to NSF-50 Sanitation Standard**
 - NSF Listing # 3R980-01
 - <http://www.nsf.com/Certified/Pools/>
- EPA Established #075659-CA-001

Delta UV declares to be in conformance with the applicable provisions of the Code of Federal Regulations (CFR) requirements including Title 21, Chapter 1, Subchapter J pertaining to radiological health.

All Delta UV systems are sized to match the maximum flow rate of the circulation pump(s). Proper installation calls for 100% of the circulation system flow to pass through the UV reactor. Slip stream or bypass installations which direct only a portion of the recirculation flow to pass through the UV reactor cannot be guaranteed to produce the required sanitation and dechloramination results and should be avoided. Delta UV systems are sized by confirming the maximum GPM flow through the reactor to produce a dose of $60\text{mJ}/\text{sec}/\text{cm}^2$, which is the proper UV-C dose for effective 99.99% (4 log minimum) kill rate for bacteria, algae and even chlorine resistant parasites such as cryptosporidium, giardia, legionella, and shigella

DELTA ULTRAVIOLET CORPORATION
1535 W Rosecrans Avenue
Gardena, CA 90249

Local Phone: 1-310-323-6400

Fax: 1-310-323-6403

Email: info@deltauv.com



IMPORTANT SAFETY INSTRUCTIONS

WARNING: This product should be installed by a professional service technician or similar person, qualified in electrical equipment installation. Improper installation and/or operation could cause serious injury, property damage, or death. Improper installation and/or operation will void the Limited Warranty

WARNING: When using electrical products, basic precautions should always be followed, including the following:

1. READ AND FOLLOW ALL INSTRUCTIONS

2. WARNING-A wire connector is provided on this unit to connect a minimum 8 AWG (8.4 mm²) solid copper conductor between this unit and any metal equipment, metal enclosures of electrical equipment, metal water pipe, or conduit within 5 feet (1.5 m) of the unit.
3. WARNING – For indoor use only. This unit is not intended for outdoor use.
4. WARNING – This product must be connected to ground-fault circuit-interrupter.
5. WARNING –Risk of Electric Shock. Install at least 5 feet (1.5 m) from inside wall of hot tub or spa or swimming pool using non-metallic plumbing
6. WARNING - Do not simply throw the old lamps into the trash as they contain Mercury and must be disposed of properly. www.lamprecycle.org

7. SAVE THESE INSTRUCTIONS



IMPORTANT SAFETY INSTRUCTIONS

1. READ AND FOLLOW ALL INSTRUCTIONS

2. **WARNING- Never look at the ultraviolet lamps when lit.** This may cause severe injuries or burns and may even lead to loss of eyesight
3. **WARNING –** Do not touch the ultraviolet lamp with bare hands, as these would leave impurities that shorten the life of the lamp. If you do touch it: clean with alcohol or white vinegar.
4. **WARNING –** Never unscrew the quartz tube sealing nut when the reactor is on load as the quartz tube could be blown out of the reactor with force and injure you
5. **WARNING –** Do not use the reactor if the power supply wire is worn or damaged. In this case it should be replaced.
6. **WARNING –** If the connecting cable between the reactor and the electrical cabinet is damaged, it must be replaced by a special cable available as a spare part.
7. **WARNING – Even when stopped, power is present in the electrical unit** so make sure that the main power supply upstream of the electrical cabinet is switched off before carrying out any work on the equipment.
8. **WARNING –** To avoid electric short-circuits; do not place the electric wires or the reactor in the pool water or in any other maintenance or cleaning fluid.
9. **WARNING –** Do not restart the system until the electric unit, the covers exterior elements of the reactor are correctly in place.

10. SAVE THESE INSTRUCTIONS



IMPORTANT SAFETY INSTRUCTIONS

IMPORTANT: Follow the instructions contained herein **EXACTLY** and **IN THE ORDER LISTED**. Once installed and maintained properly, your UV system will provide years of successful operation

REQUIREMENTS

The Cabinet must be installed in a technical room or **protected from weather (rain, snow, freezing, extreme heat, etc.)**

The reactor must be installed in a **dry zone**.

The installation zone temperature must be **within 32°F and 104°F**.

Ambient humidity must be **< 80%**.

Make sure you choose a position where the lamp can be taken out – the **AVAILABLE HEIGHT should be DOUBLE** the total height of the appliance.

The reactor **must be installed** after the filter(s) or install strainer / Y-strainer before inlet side of reactor

Keep any sources of hydrochloric acid vapours away from the installation.



- **Maximum cable length** between the UV reactor and the electrical unit is **3 meters (10ft.)**.



- **Before accessing the connection terminals, ensure that all supply circuits are disconnected.**
- The reactor installation as a whole must be protected with a **suitably adapted circuit breaker**.
(See A. Technical characteristics)
- Check that cable complies with legislation and the required power level.
(See A. Technical characteristics)



- Do not use the Delta UV reactor for any other use than that for which it was designed.

TABLE OF CONTENTS :

Pages

A. TECHNICAL SPECIFICATION.....	8
B. INSTALLATION INSTRUCTION.....	10
C. STARTING UP.....	13
D. USE.....	14
E. MAINTENANCE.....	16
F. TROUBLESHOOTING.....	22
G. ALARM CONTACT.....	22

ANNEX 1: Clearance dimensions - Blown up view - Designation

ANNEX 2: Electrical diagrams

We thank you for choosing a disinfection reactor from the UV HO range.
Our equipment has been designed to provide long term, reliable service.

Our equipment has been designed to give you reliable and safe operation for many years to come.

The reactors in the UV HO range have been designed for speed and ease of installation.
Their design also makes them easy to maintain

Read these instructions carefully in order to optimize the operation of your reactor.

Instruction Manual Icon Identification

To aid the reader in understanding the importance of various items contained within this manual, Icons are used to throughout this manual to identify the area of importance of the selected item. The five icons used and their significance are:



This icon advises the reader that the information following is of **key importance**



This Icon alerts the reader that the information noted regards a potential **safety hazard**



This Icon alerts the reader that the information noted regards a potential **heat related safety issue**



This Icon alerts the reader that the information noted regards a potential **vision related safety issue**



This Icon alerts the reader to **use gloves when touching an object**

A. TECHNICAL SPECIFICATIONS

Reactor	ELP28HO HDPE	ELP38HO HDPE	ELP48HO HDPE	ELP58HO HDPE	ELP68HO HDPE	ELP78HO HDPE	ELP 610HO HDPE
Material	HDPE						
Maximum pressure	43 psi						
Reactor diameter	9.843"	9.843"	9.843"	9.843"	9.843"	9.843"	12.402"
Total Length (in)	37.709"	37.709"	37.709"	37.709"	37.709"	37.709"	37.709"
Volume (US Gallon)	8.52	8.4	8.28	8.16	8.04	7.92	12.90
Connection type	flanges						
Standard connection	3"	3"	3"	4"	4"	4"	6"
ELECTRICAL UNIT							
Type	ABS						
Dimensions (in)	19.68 x 15.75 x 7.87	19.68 x 15.75 x 7.87	19.68 x 15.75 x 7.87	19.68 x 15.75 x 7.87	19.68 x 15.75 x 7.87	19.68 x 15.75 x 7.87	19.68 x 15.75 x 7.87
Power supply	120V						
Magnetothermic protection	20 A	20 A	20 A	20 A	20 A	20 A	20 A
Curve of release of the circuit breaker	Curve C	Curve C	Curve C	Curve C	Curve C	Curve C	Curve C
Power supply conductor	60°C Copper 2 x AWG12						
On / Off switch	Yes	Yes	Yes	Yes	Yes	Yes	Yes
Power on indicator light	Yes	Yes	Yes	Yes	Yes	Yes	Yes
UV lamp indicator light	Yes	Yes	Yes	Yes	Yes	Yes	Yes
UV Sensor	Yes	Yes	Yes	Yes	Yes	Yes	Yes
Temperature sensor	Yes	Yes	Yes	Yes	Yes	Yes	Yes
Display	Digital hour counter + Millenium III						
Temperature rating of field-installed connectors	60°C ONLY						
Protection index	IP 54 – NEMA 3S						
UV Lamp							
Number of lamp	2	3	4	5	6	7	6
Electrical power	191 W	287 W	383 W	478 W	574 W	670 W	574 W
Unit UV-C power	28 W	28 W	28 W	28 W	28 W	28 W	28 W
Total UV-C power	56 W	84 W	112 W	140 W	168 W	196 W	168 W
Service life of lamps							
Performances							
Flow rate at >40 mJ/cm²	79 GPM	116 GPM	158 GPM	254 GPM	295 GPM	329 GPM	396 GPM

(1) At the end of the lifetime of the lamps, at the most unfavorable point in reactor, for a transmittance of 98%.

HEAD LOSS CURVE

Head loss
(psi)

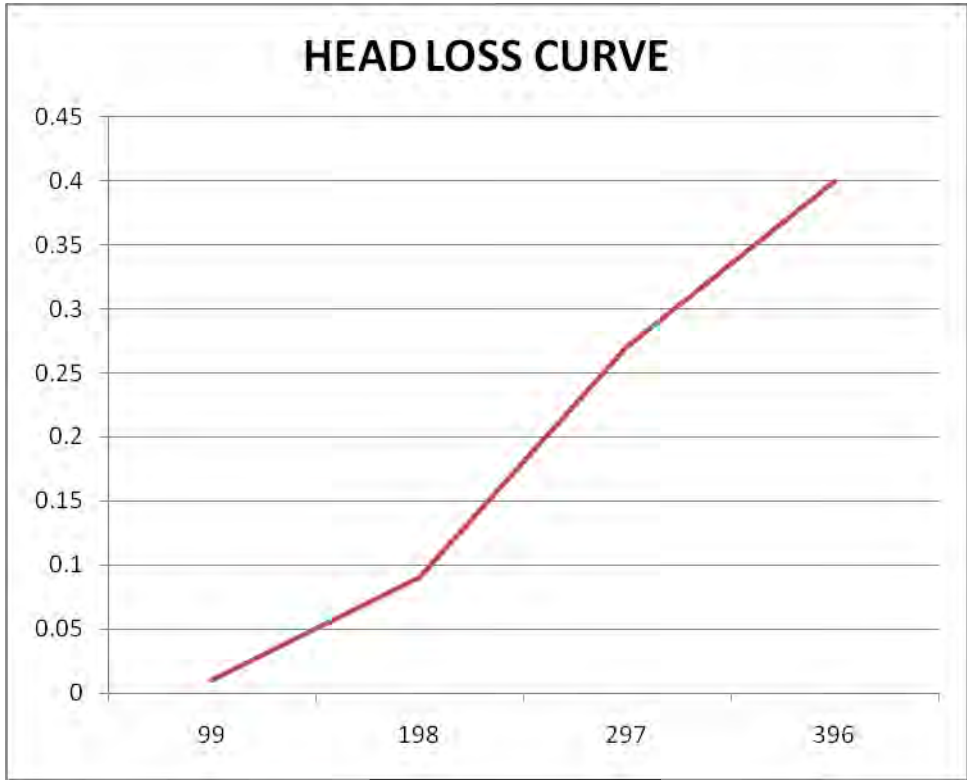

Flow rate (gpm)

THE ELECTRICAL UNIT: CONFIGURATION

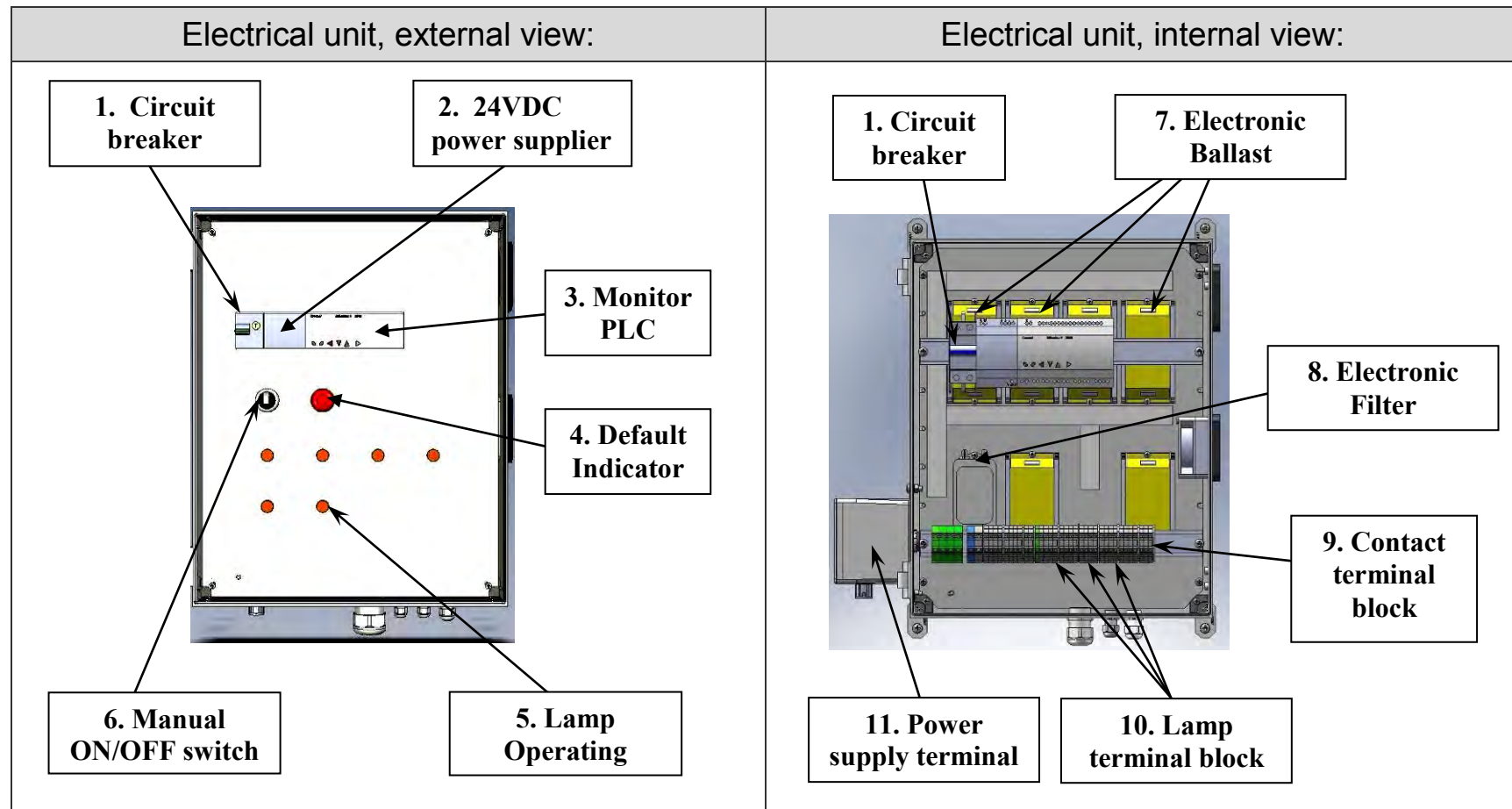

B. INSTALLATION INSTRUCTIONS

ELP HO range reactors are ready to install, no work is required inside the reactor.

B. 1 RECOMMENDED INSTALLATION DIAGRAM

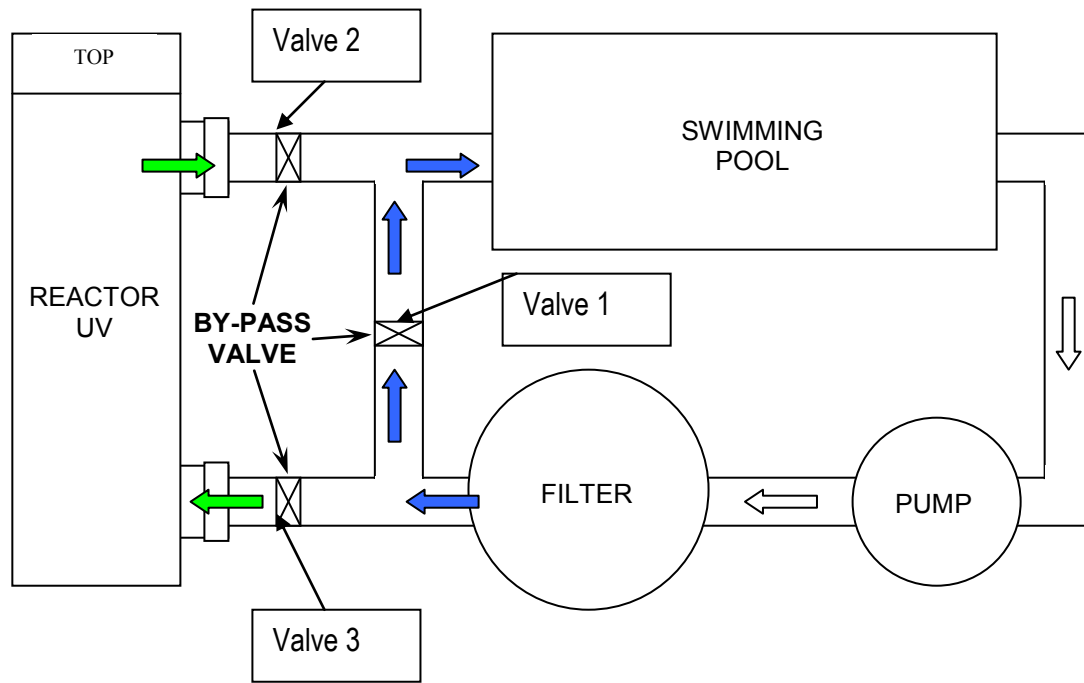

The reactor **must be installed** after the filter(s) and plumbed into the bottom and out the top.

The full flow of the circulation system must flow through the UV reactor chamber. However, in order to provide serviceability of the UV reactor without the necessity of shutting down the circulation system, it is desired to provide a piping bypass system in the circulation piping. The pipe size of the bypass should be the same size pipe of the circulation system at the bypass location. Three valves are required to accommodate a full bypass of the UV reactor. One valve is a bypass valve that normally remains closed at all times while the UV system is in operation, and two valves isolate the UV reactor (in closed position) when accessing the reactor for normal service such as quartz tube or wiper ring replacement).

If you use the bypass the water circulation go through the bypass (blue arrows)

If you do not use the bypass the water circulation go through the reactor (green arrows)

To isolate the UV reactor during the maintenance: **Open** the By-Pass

- Open the valve 1
- Close the valve 2 and the valve 3

After maintenance: **Close** the By-Pass

- Open the valve 2
- Open slowly the valve 3
- Close the valve 1

B. 2 ELECTRICAL UNIT INSTALLATION

- Position the unit **away from water**.
- The ventilator **must not be blocked**.
- Maximum cable length between the UV reactor and the electrical unit is 10 feet.

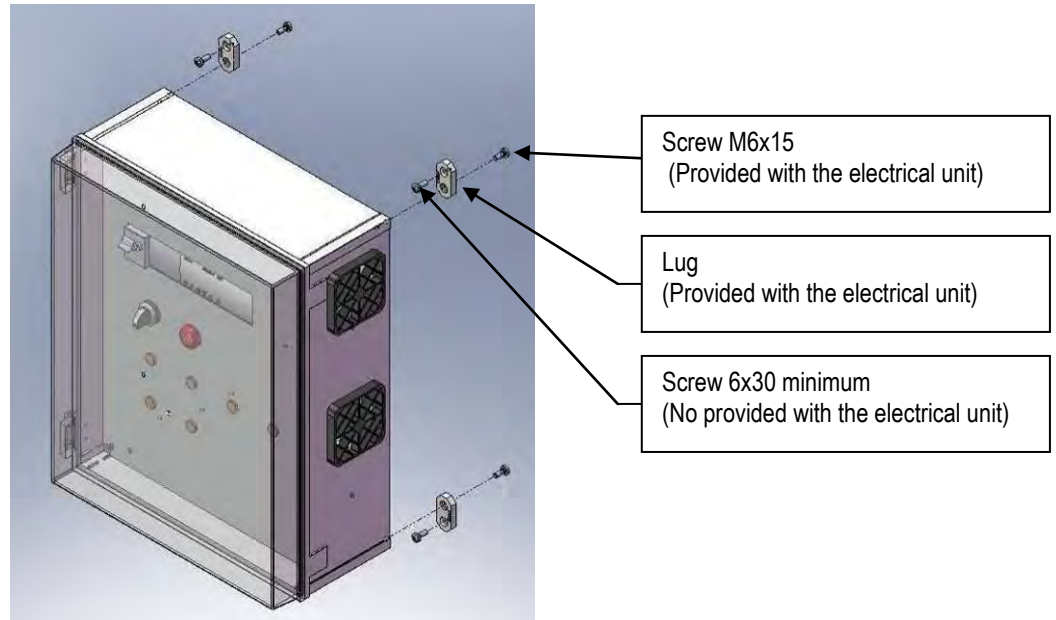

Diagram: fixing of electrical unit in the wall

B.3 FIELD WIRING DIAGRAM



Use copper conductors only
 Permanently Connected Equipment Assembly with Ultra Violet Lamps,
 Ballasts and Control.

The cabinet **should be energized 24/7** and must be slaved to the filtration in order to disinfect at the same time.

DIAGRAM: Wiring Terminal

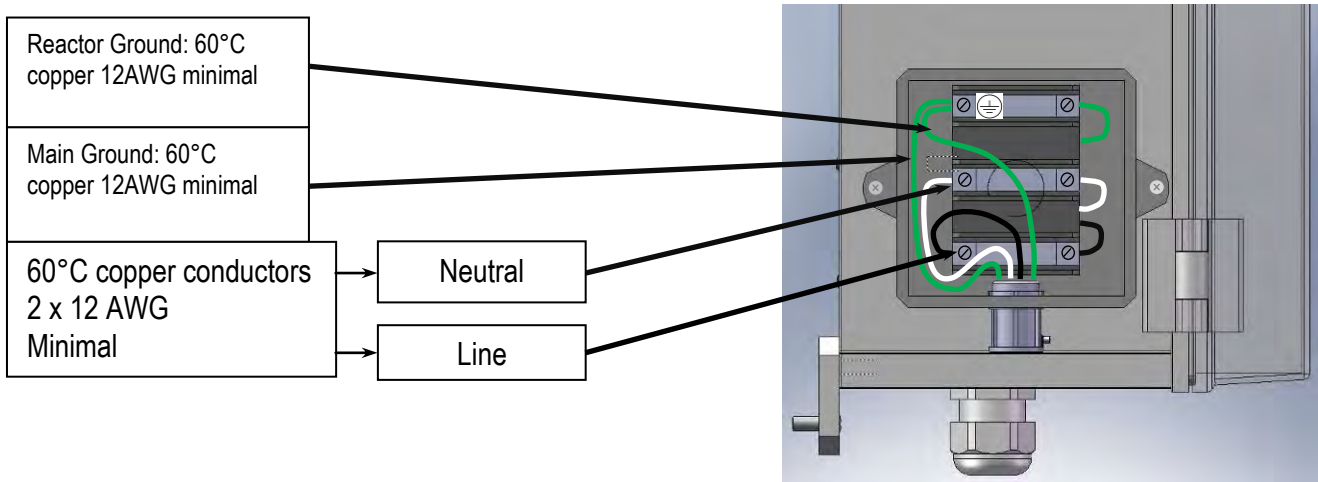

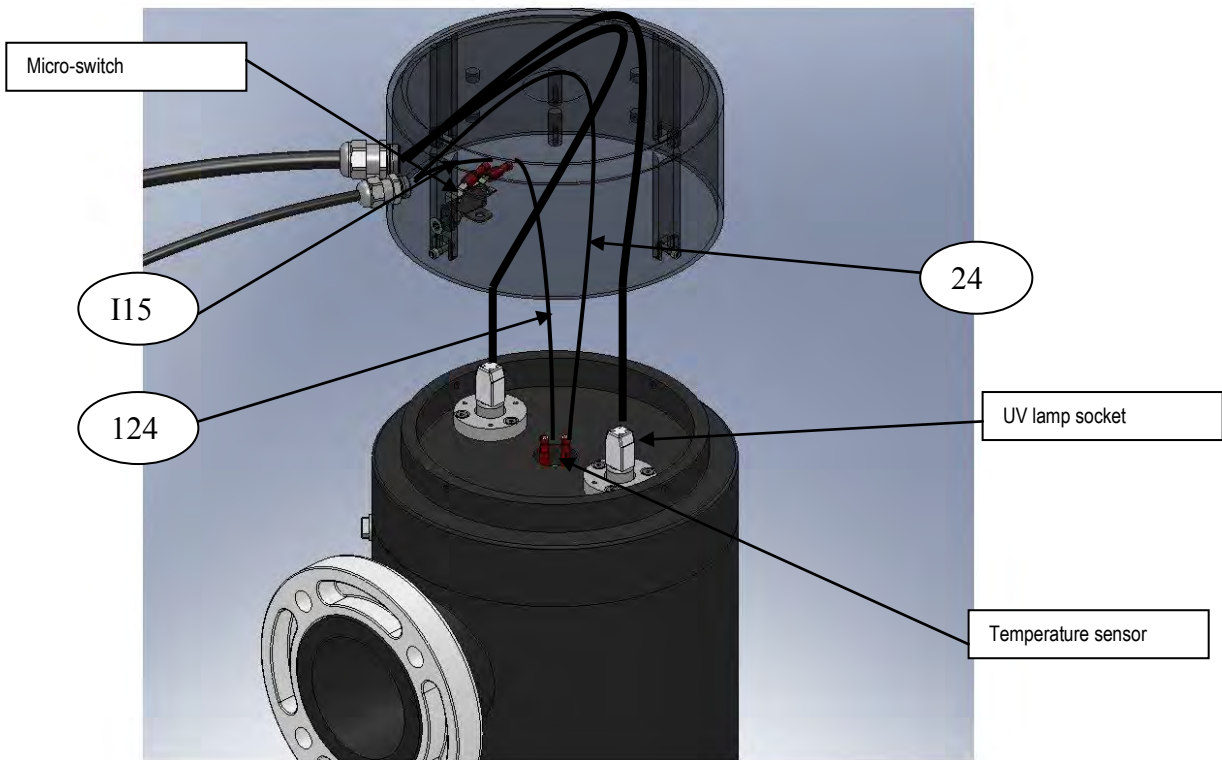

Diagram: Terminal connecting in the reactor

I15	Please report to the electrical diagram : annex 2
24	
124	

- External interconnecting flexible cords must to be installed in a restricted access location only accessible by qualified persons.
- External interconnecting flexible cords must be secured off the floor and to the mechanical structure.

C.STARTING UP

C.1 Starting the UV lamp

1	Check that the electrical connection is compliant.
2	Check that the bonnet is positioned correctly on top of reactor.
3	Turn on filtration pump and make sure water is running through reactor
4	Switch on the Lamp
5	Check that the lamps are working properly: the indicator light for each lamp should be lit

C.2 Setting the UV Monitor



OPERATION for CALIBRATION

1. Turn on the on/off switch on the front of the electrical cabinet.
2. The UV C lamps will heat up to their maximum output level in 5 minutes (depending on the temperature of the liquid being treated). **Now you have to calibrate the sensor in its liquid environment:**

3. . On the Millenium III monitor face, press the  key for five (5) seconds

4. The monitor LCD screen will display:

```
RFC OK->UVC SENSOR  
CALIBRATION  
B->SETTING ALARMS  
ESC->CANCEL  
^
```

5. . Press the  key to initialize the UV sensor at 100% or to cancel calibration.
6. Press the  key.

YOUR UV UNIT IS NOW DISINFECTING FOR THE INDICATED FLOW RATE A 100%.

D. USE

D.1 MANUAL OF THE MONITOR DELTA-UV MIII

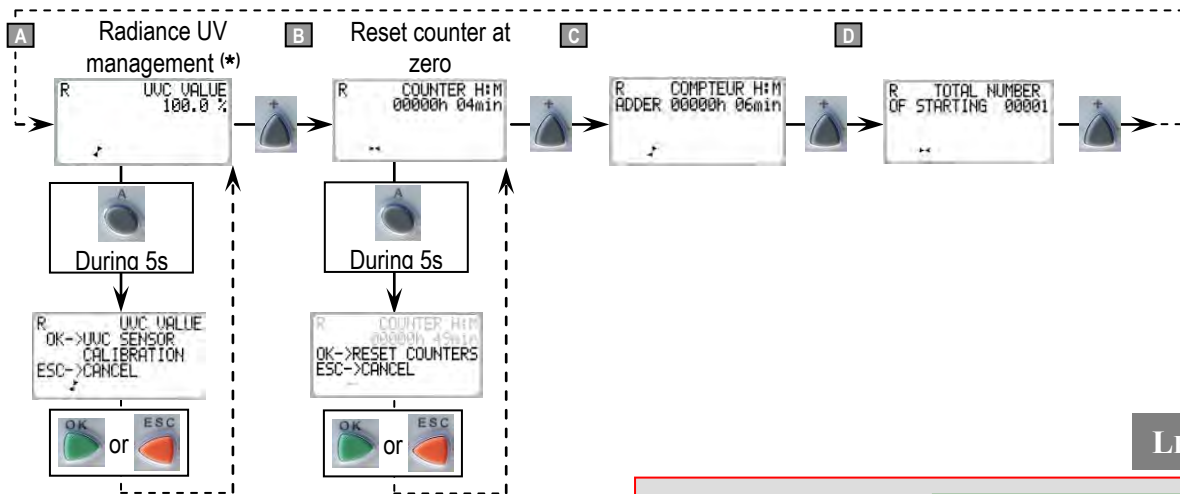

LEGEND

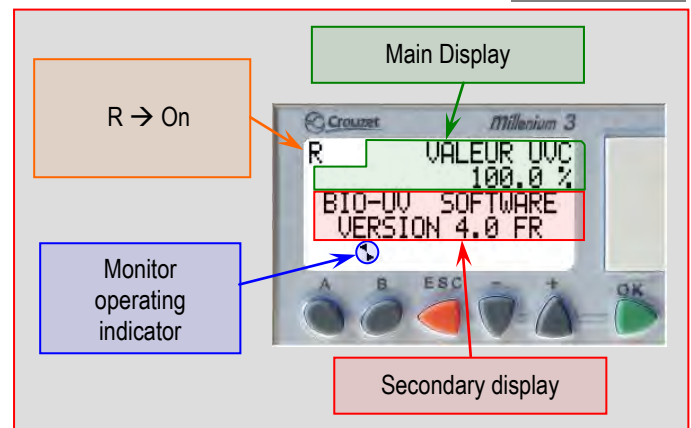

GENERAL INFORMATION:

Definition of the letter on the first display

R Means that the reactor is switched on and operating.

- **The screen is backlit:** Just pressing on a key switches the back lighting on for one minute.

ALERT MESSAGES:

The screen flashes when there is an alert message.

The alert messages are always shown on the secondary display and are independent of what is displayed on the main display unit.

Display	Meaning of the alert	Solutions
	This message appears when the temperature of the reactor is excessive or if the reactor's cover is removed. The lamps are stopped automatically.	Check that enough water is flowing through the installation and the cover is correctly closed. To reset the default : press 'OK'
This alert message can be cleared by pressing on the key "OK". It is preferable to carry out a maintenance operation before clearing the fault.		
	This message appears when the intensity of the UVC radiation falls below the pre-alarm threshold.	Check that the UV sensor is calibrated. Check that the UV sensor is clean. Check that the quartz sleeves are clean.
N.B.: when the lamps have been operating for a certain number of hours, this message appears naturally (normal wear of the lamps)		
	This message appears when intensity of the UVC radiation falls below the main-alarm threshold.	Check that all UV lamps are on. Check that the UV sensor is clean. Check that the quartz sleeves are clean.
These 2 messages cannot be cleared unless the problem has been resolved.		

CONTENT OF MENUS AND SUB-MENUS:

Use the + or – keys to change from one menu to another.

Press on key A for 5 seconds to enter a menu.

When the word "OFF" is displayed, this means that the display option is not available on your device.

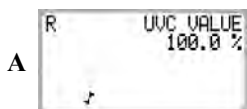

Display of UVC intensity measured by the sensor.

N.B.: each time the lamp is changed, you **MUST** calibrate the sensor **even if the display already shows 100%**.

Calibrating the sensor:

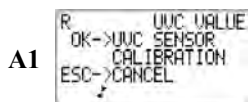

- It is important to carry out this operation when commissioning the reactor and also when changing a lamp **even if the display already shows 100%**.

- It is important to wait 5 minutes before carrying out the calibration, to allow the lamps to heat up.

- If your device is equipped with the power regulator, it is **ESSENTIAL** to switch over to manual regulation (100%) before calibrating the sensor..

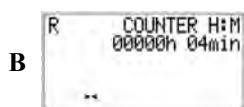

Display of lamp operating time. It is recommended to reset this counter at zero when you change a lamp.



Reset the hour counter and the number of lamp start-ups at zero.

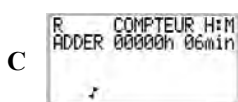

Display the reactor's total operating time since commissioning. This counter cannot be reset at zero.

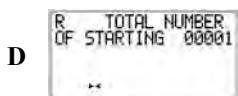

Display of the number of lamp start-ups carried out. Resetting at zero is linked to that of the hour counter.

D.2 TEMPERATURE SENSOR

The temperature sensor is located inside the cover of the reactor.

If the temperature of the reactor is excessive, the system is switched off and the red indicator lights.

In this case:

- Check your pump, and if OK: Push the 'OK' button on the Millenium to reset the default.

D.3 MICRO SWITCH

The micro- switch is located inside the cover of the reactor.

When the cover is open, the micro-switch will switch the UV lamps OFF, and the red indicator lights.









When the cover is closed; push the 'OK' button on the Millenium to reset the default



E. MAINTENANCE

E.1 REPLACE/REMOVE UV LAMPS: **20 minutes**

TOOLS REQUIRED – Standard Hex Key Set

When a lamp is defective, we recommend changing all lamps. (Except units with 3 or more lamps is less than 4 000 h)





		<p align="center">DANGER : ULTRAVIOLET RADIATION Disconnect Power Before Replacing Lamp</p>
1		<p>SWITCH OFF the power supply on the front panel of the electrical cabinet, Let lamps cool off for 10 minutes. <u>YOU MUST STOP</u> THE POOL/SPA FILTRATION.</p>
2		<p align="center">Remove the bonnet at the top. Do not remove the transparent washer of the quartz sleeve (it's not necessary to change only the lamps)</p>
3		<p align="center">Remove each lamp connector</p>
4		<p>Make sure that UV lamps are sufficiently cooled before handling it.</p>
5		<p>Take the top of the lamp and disengage the lamp from the quartz sleeve, keeping it correctly aligned with the axis. Carry out this operation CAREFULLY without touching the bulb with your fingers.</p>
6	<p align="center">Put the new lamp by the ceramic cap without touching the body of the lamp <i>(if you do so, clean the lamp with a soft cloth and some methylated spirits)</i></p>	
7		<p align="center">Engage the lamp in the quartz sleeve keeping it correctly aligned with the axis inside the equipment.</p>
8		<p align="center">Attach temperature connector and each lamp connector.</p>



9		Refit the bonnet.
10		Please follow the starting instructions in Section C page 14

E.2 CHANGE/CLEAN QUARTZ SLEEVES AND O-RINGS: 20 minutes

TOOLS REQUIRED – Standard Hex Key Set

Make the operations 1 to 5 of the remove UV lamps operation (see previous page)

1	<p style="text-align: center;">Drain the unit :</p> <p style="text-align: center;">1. CLOSE the valves up- and downstream of the reactor, open the by-pass 2. EMPTY THE REACTOR by removing both drain plugs.</p>	
2		<p>Remove the transparent washer by unscrewing the three screws.</p>
3		<p style="text-align: center;"><u>Take out the quartz sleeve carefully:</u></p> <p style="text-align: center;">Insert your thumb or another finger in the sleeve and slowly lift the quartz sleeve until the O-ring comes free from its housing.</p>
4		<p>Take hold of the quartz sleeve and extract it fully MAKING SURE that you keep it correctly aligned with the axis.</p>
5		<p style="text-align: center;">The quartz sleeve exterior can normally be cleaned by using acid or spirit vinegar or pH minus (liquid) with weak concentration. (Ratio of 4 parts water to one part acid). Do not use abrasive cleaners.</p>
REASSEMBLY		
6		<p>CAREFULLY insert the sleeve in the unit, keeping it correctly aligned with the axis. Your medium or index finger will help you to correctly drive and to find easier the socket at the bottom.</p> <p>With a finger inside the sleeve, position the quartz in its socket at the bottom of the equipment. The quartz should protrude slightly (by the thickness of the O-ring), It should not be dropped right to the bottom.</p>

7		<p>Lubricate the new O-ring with rubber lubricant. (Put a new O-ring at each change of quartz tube)</p> <p>Position the O-ring around the sleeve and push it fully home in its housing using your finger nail (Do not use any tool).</p>
8		<p>Screw on the transparent washer</p>
9		<p>Open the valve, start the filtration, when the unit is under pressure the vessel is pressured, and then you can check that there is no leakage in the quartz tube and at the watertightness.</p>
10		<p>Follow instructions 6 to 10 of Replace/remove UV lamps (see previous pages)</p>

E.3 QUARTZ SLEEVES: CLEANING IN PLACE

To set this operation, you need:

- To install a PVC tank with a transparent tube with the following dimensions: Diameter 2", length 20". This tube will be above a PVC valve.
- 1 quart of muriatic acid

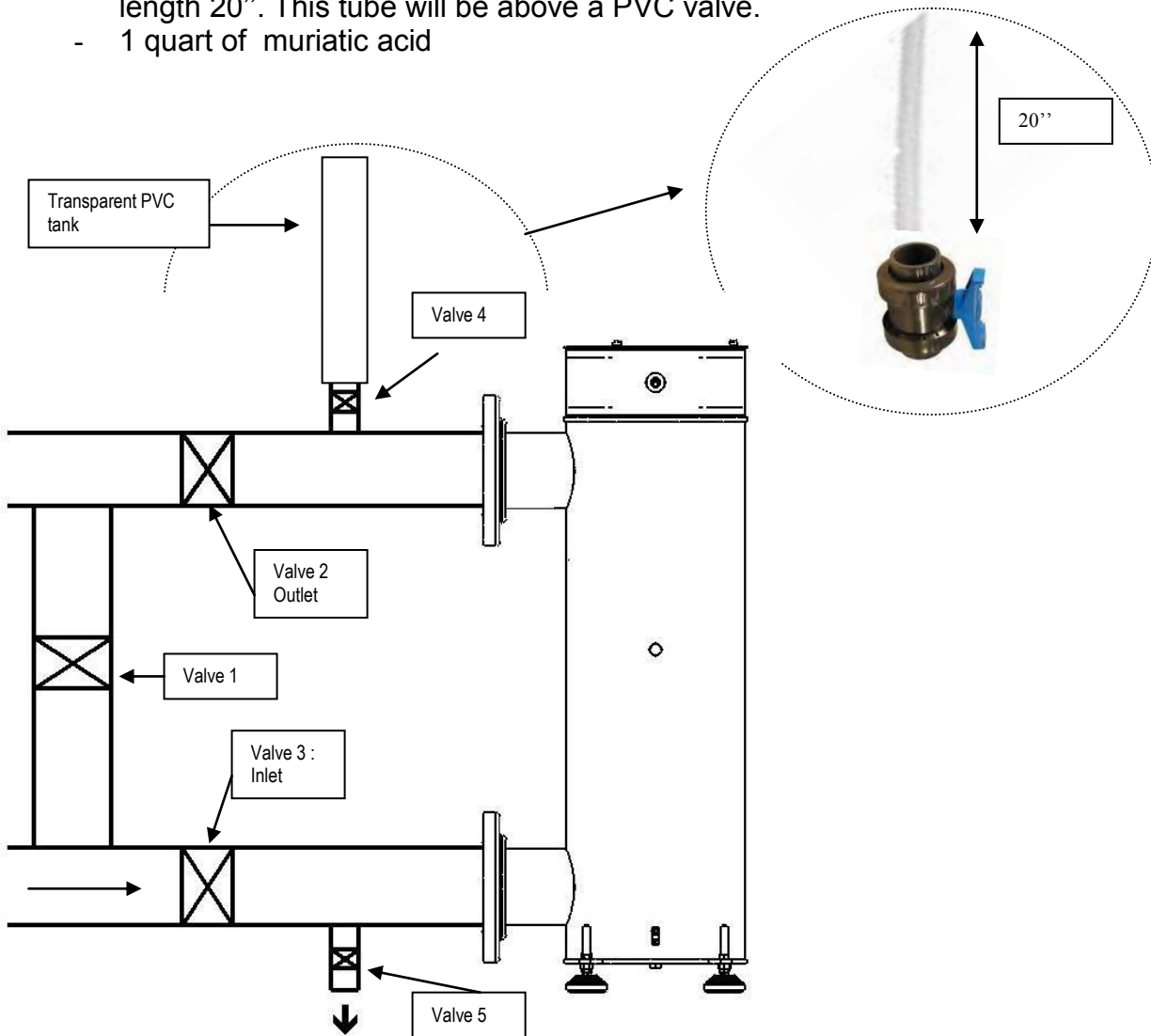

STEP	OPERATION	
1	Open the valve 1 and close the valves 2 and 3	
2	Fill the PVC tank with 1 quart of muriatic acid	
3	Open the valve 4	
4	Open slowly the valve 5 till the level of the PVC goes down, then close valve 5	
5	Close valve 4	
6	Leave it for 1 hour	
7	Open the valve 5 and empty the UV reactor	
8	Close the valve 4 and 5	
9	Run the UV reactor on <ul style="list-style-type: none"> - Open the valve 2 - Open slowly the valve 3 - Close the valve 1 	

E.4 MAINTENANCE FILE



CAUTION :

This sheet must be kept up to date.

It provides a record of the reactor's operating cycle.

Date	ACTION	By

F. TROUBLESHOOTING

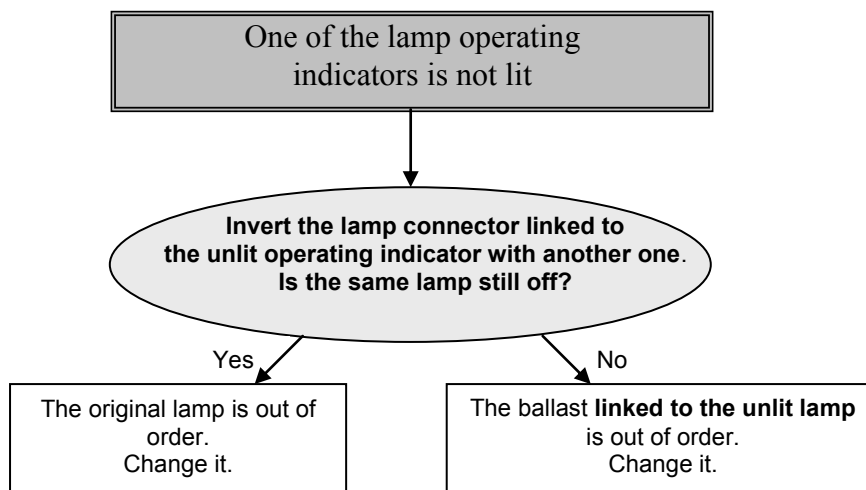

The screen flashes when there is an alert message.

The alert messages are always shown on the secondary display and are independent of what is displayed on the main display unit.

Display	Meaning of the alert	Solutions
	This message appears when the temperature of the reactor is excessive or the reactor's cover is removed. The lamps are stopped automatically.	Check that enough water is flowing through the installation and the cover is correctly closed. To reset the default : press 'OK'
This alert message can be cleared by pressing on the key "OK". It is preferable to carry out a maintenance operation before clearing the fault.		
	This message appears when the intensity of the UVC radiation falls below the pre-alarm threshold.	Check that the UV sensor is calibrated. Check that the UV sensor is clean. Check that the quartz sleeves are clean.
N.B.: when the lamps have been operating for a certain number of hours, this message appears naturally (normal wear of the lamps)		
	This message appears when intensity of the UVC radiation falls below the main-alarm threshold.	Check that the all UV lamps are on. Check that the UV sensor is clean. Check that the quartz sleeves are clean.
These 2 messages cannot be cleared unless the problem has been resolved.		

Cleaning UV Sensor:

Disconnect the UV sensor cable. Unscrew the UV sensor from the vessel. With a soft cloth, wipe the lens of the UV sensor clean (do not use anything abrasive on the lens). Re-install the UV sensor by screwing it back into the vessel. **Be extremely careful not to cross thread the UV sensor, if threads are damaged it will not be repairable and is not covered under warranty.**

G. ALARM CONTACTS

The main-alarm fault is indicated by snap contacts on the monitor which are transmitted to terminal strips (see the wiring diagram in order to identify them).

Notice: these snap contacts are dry contacts.

WARRANTIES

The units of the HO range are guaranteed subject to the following conditions:

- 5 years for the HDPE reactor (materials and welding)
- 2 years for all other components, except the UV lamp, O-rings, Quartz Tubes (consumable) 1 year.

Electrical components are not guaranteed against overvoltage and lightening damage.



CAUTION: The quartz sleeve and the lamps are not guaranteed against breakage.

- Faulty parts must be returned to **Delta UV**, with details of the unit type and serial number, for exchange after technical evaluation.
- Shipping costs will be shared between the retailer and **Delta UV**.
- The guarantee runs from the day of installation: this date must be notified to **Delta UV** by returning the guarantee validation form by post or fax.

- If the instructions for installation and use are not followed, **Delta UV** cannot accept responsibility and the guarantees will be considered null and void.

DELTA ULTRAVIOLET CORPORATION
1535 W. Rosecrans Avenue
Gardena, CA 90249
Local Phone: 1-310-323-6400
Fax: 1-310-323-6403
Email: info@deltauv.com

PARTS LIST

N°	DESIGNATION	REFERENCE
1	Circuit breaker	70-02600
2	24Vdc power supplier	70-02601
3	Monitor MIII / PLC	70-02602
4	Default indicator	70-02603
5	Lamp indicator	70-02604
7	Electronic ballast	70-10600
8	Electronic filter	70-02605

N°	DESIGNATION	REFERENCE
	UV lamp	70-18600
	O-Ring d25x5	44-02260
	Quartz sleeve	58-50600
	Micro-switch	70-02257
	Bimetal Thermostat	70-02606
	UV SENSOR	70-02607-T

ANNEX 1

Clearance dimensions

Blown up view

Designation



ANNEX 2

Electrical diagrams

