

F-2000

INSTRUCTION MANUAL



Blue-White[®]
Industries, Ltd.

5300 Business Drive
Huntington Beach, CA 92649
USA

Phone: 714-893-8529 **FAX:** 714-894-9492

E mail: sales@blue-white.com or techsupport@blue-white.com

Website: www.blue-white.com

TABLE OF CONTENTS

<u>SECTION</u>	<u>HEADING</u>	<u>PAGE</u>
1.0	Introduction	3
2.0	Features	3
3.0	Applications	3
4.0	Specifications	4
4.1.....	Physical.....	4
4.2.....	Dimensional Drawing.....	5
4.3.....	Temperature vs. Pressure Graph.....	6
5.0	Flow ranges	7
6.0	Mounting Options	8
7.0	Electrical Wiring Connections	10
7.1.....	Enclosure Knock-Out Instructions.....	10
7.2.....	Optional Circuit Board Installation.....	10
7.3.....	Model RT Circuit Board Wiring.....	11
7.4.....	Model FHXX and FCXX Sensor Wiring.....	12
8.0	Operation	13
8.1.....	Theory of operation.....	13
8.2.....	Model RT Operation.....	14
8.2.1.....	Model RT Applications.....	14
8.2.2.....	Model RT Features.....	15
8.2.3.....	How to Determine Calibration Constants.....	15
8.2.4.....	Programming the Model RT.....	18
8.2.5.....	Calibration Constants.....	20
8.3.....	Programming flow chart.....	22
9.0	Maintenance	23
9.1.....	F-2000 parts list.....	24
9.2.....	F-2000 exploded view.....	25
9.3.....	Troubleshooting.....	26

1.0 INTRODUCTION TO THE F-2000

Congratulations on purchasing the F-2000 electronic flow meter. The F-2000 is designed to measure the flow of a fluid in a pipe. The meter is factory calibrated to any engineering units and displays the rate of flow or the total of flow on a 6 digit LCD display. Two AAA batteries power the unit for up to one year.

There are four models are available:

RT = Rate and Totalizer

AO = 4-20mA, 0-10 VDC Analog Output, flow rate and totalizer

PC = Batch processing, flow rate alarm, proportional chemical metering, flow rate and totalizer.

AP = Analog output, batch processing, flow rate alarm, proportional chemical metering, flow rate and totalizer.

2.0 FEATURES

- Battery powered rate and total
- Extended battery life mode (screen blanks after 30 seconds)
- Easy to read, eight digit LCD display
- Installs quickly on existing pipe
- Factory programmed
- Field programmable front panel push buttons
- No pressure drop
- Weather resistant enclosure (NEMA 4X)
- Corrosion resistant PVDF sensor
- Corrosion resistant ABS enclosure
- High accuracy
- Extended flow range
- Front panel security lockout
- Minimal maintenance required

3.0 APPLICATIONS

Model AO

- Measure and display the flow rate
- Measure and display the total flow
- Control external devices with 4-20mA control signal
- Control external devices with 0-10VDC control signal

Model RT

- Measure and display the flow rate
- Measure and display the total flow

Model PC

- Measure and display the flow rate
- Measure and display the total flow
- Maintain a flow rate range alarm
- Trigger a high flow rate alarm
- Trigger a low flow rate alarm
- Manually controlled batch processing
- Timed auto-reset batch processing
- Proportional flow chemical pump process control

4.0 SPECIFICATIONS**4.1 Physical**

Maximum Working Pressure.....	300 psig (20.7 bar)
Maximum fluid temperature.....	200°F (93°C) - saddle and sensor only 200°F (93°C) - polypropylene and PVDF 140°F (60°C) - molded PVC tee units 140°F (60°C) - when mounted on PVC
Ambient temperature range.....	32°F (0°C) to 110° F (43°C)
Enclosure.....	NEMA 4X (acceptable for outdoor use)
NOTE: Protect the LCD display from direct sunlight.	
Sensor Accuracy.....	±1% of full scale reading
Repeatability.....	±1% of full scale reading
Power requirements.....	15 VDC Nominal (15 - 24 VDC Absolute - DO NOT EXCEED 24.0 VDC)
Model RT units only.....	Four standard AA alkaline batteries or 15-24VDC Plug in transformer (Battery life expectancy 1 year minimum)
All units.....	15-24VDC (plug-in transformer supplied)
Model AO analog output board.....	Linear, Non-isolated, powered loop. (250 ohm max for 4-20 ma / 500 ohms minimum for 0-10 VDC)
Model PC Process control board.....	Relay SPDT, NO/NC Maximum switching load 8 amps @ 115 VAC, 220 VAC, 230 VAC 7 amps @ 30 VDC (resistive load)
Maximum fluid debris size.....	0.020" diameter

4.2 Dimensional Drawing

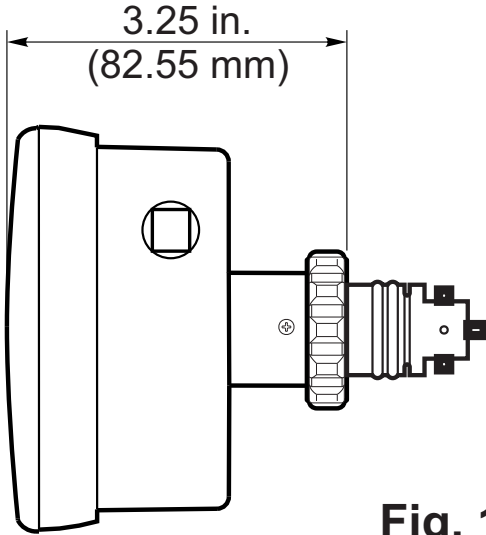
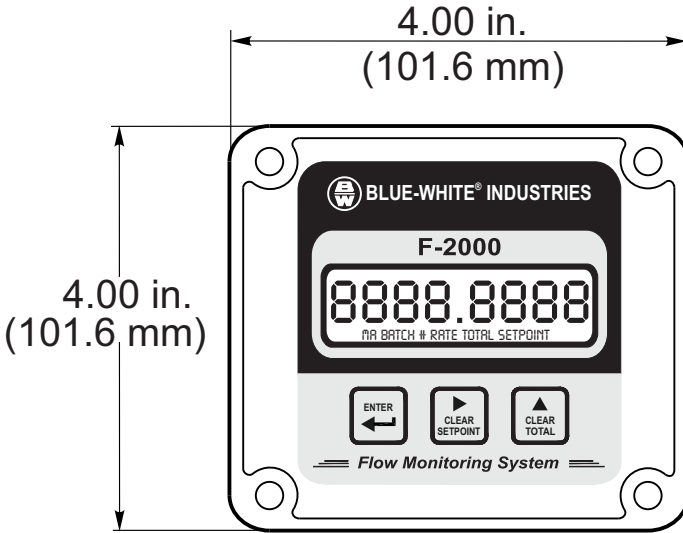
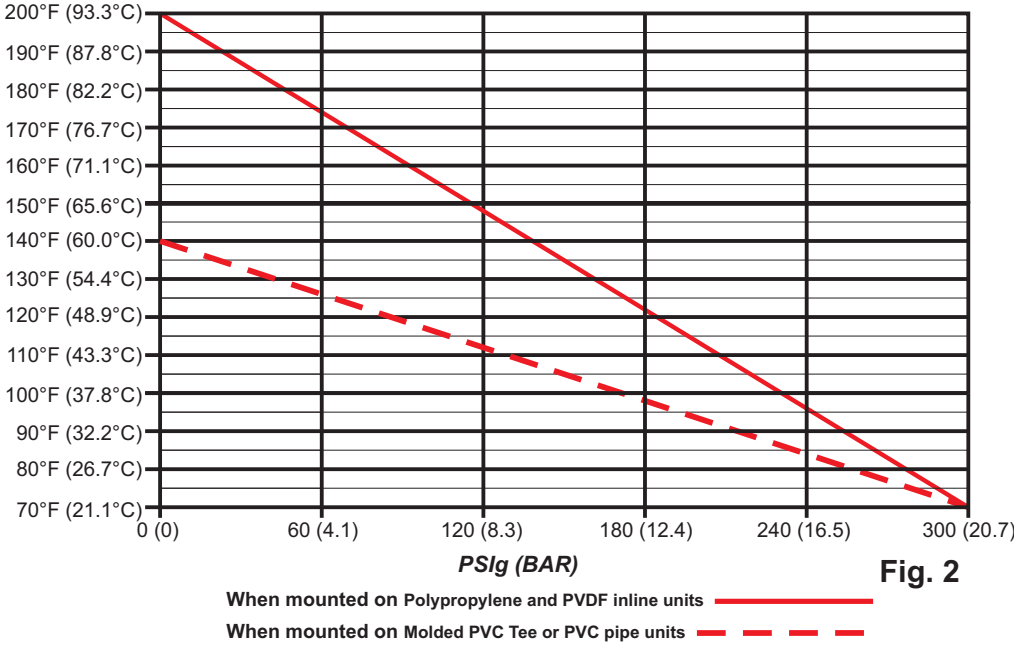

Fig. 1

4.3 Temperature vs. Pressure

Temperature



Note: Pressure and temperature limits are inversely proportional.

5.0 FLOW RANGES

Note: Due to increased wear on the paddle and axle, continuous operation at the upper 25% of the flow range is not recommended

METRIC PIPES

SADDLES - Standard Flow [Min - Max]

Pipe Size	LPM 1	LPH 1	M3H 1
50 MM - PN 10 & 16	70.0 - 700.0	4200 - 42000	4.20 - 42.00
63 MM - PN 10 & 16	110 - 1100	6600 - 66000	6.60 - 66.00
75 MM - PN 10 & 16	150-1500	9000 - 90000	9.00 - 90.00
90 MM - PN 10 & 16	230 - 2300	13800 - 138000	13.8 - 138.0
110 MM - PN 10 & 16	350 - 3500	21000 - 210000	21.0 - 210.0
160 MM - PN 10 & 16	720 - 7200	43000 - 430000	43.0 - 430.0
200 MM - PN 10 & 16	1150 - 11500	70000 - 700000	70.0 - 700.0
160 MM - PN 10	1700 - 17000	100000 - 1000000	100 - 1000
200 MM - PN 10	2700 - 27000	170000 - 1700000	170 - 1700

IPS PIPES

MOLDED INLINE BODIES [Min - Max]

Pipe Size	RANGE#	GPM	GPH	GPD	LPM	LPH	M3H
3/8"	1	.800 - 8.000	48.0 - 480.0	1100 - 11000	3.00 - 30.00	180 - 1800	0.180 - 1.800
3/8"	2	.400 - 4.000	20.0 - 200.0	550 - 5500	1.00 - 10.00	60.0 - 600.0	0.060 - 0.600
1/2"	1	2.00 - 20.00	120 - 1200	2800 - 28000	7.00 - 70.00	420 - 4200	0.420 - 4.200
1/2"	2	.500 - 5.000	30.00 - 300.0	700 - 7000	2.00 - 20.00	120 - 1200	0.120 - 1.200
3/4"	1	3.00 - 30.00	180 - 1800	4320 - 43200	11.0 - 110.0	660 - 6600	0.660 - 6.600
3/4"	2	.800 - 8.000	48.0 - 480.0	1100 - 11000	3.00 - 30.00	180 - 1800	0.180 - 1.800
1"	1	5.00 - 50.00	300 - 3000	7200 - 72000	20.0 - 200.0	1200 - 12000	1.20 - 12.00
1"	2	2.00 - 20.00	120 - 1200	2800 - 28000	7.00 - 70.00	420 - 4200	0.420 - 4.200
1-1/2"	1	4.00 - 40.00	240 - 2400	5700 - 57000	15.0 - 150.0	900 - 9000	0.900 - 9.000
1-1/2"	2	6.00 - 60.00	360 - 3600	8600 - 86000	25.0 - 250.0	1500 - 15000	1.50 - 15.00
1-1/2"	3	10.0 - 100.0	600 - 6000	14400 - 144000	40.0 - 400.0	2400 - 24000	2.40 - 24.00
2"	1	4.00 - 40.00	240 - 2400	5700 - 57000	15.0 - 150.0	900 - 9000	0.900 - 9.000
2"	2	6.00 - 60.00	360 - 3600	8600 - 86000	25.0 - 250.0	1500 - 15000	1.50 - 15.00
2"	3	10.0 - 100.0	600 - 6000	14400 - 144000	40.0 - 400.0	2400 - 24000	2.40 - 24.00
2"	4	20.0 - 200.0	1200 - 12000	28800 - 288000	70.0 - 700.0	4200 - 42000	4.20 - 42.00

SADDLES - Standard Flow [Min - Max]

Pipe Size	GPM 1	GPH 1	GPD 1	LPM 1	LPH 1	M3H 1
1-1/2" IPS	15.0 - 150.0	900 - 9000	21500 - 215000	60.0 - 600.0	3600 - 36000	3.60 - 36.00
2.0" IPS	30.0 - 300.0	1800 - 18000	43000 - 430000	100 - 1000	6000 - 60000	6.00 - 60.00
2.5" IPS	40.0 - 400.0	2400 - 24000	57600 - 576000	150 - 1500	9000 - 90000	6.00 - 60.00
3.0" IPS	60.0 - 600.0	3600 - 36000	86500 - 865000	250 - 2500	15000 - 150000	15.0 - 150.0
4.0" IPS	100 - 1000	6000 - 60000	144000 - 1440000	400 - 4000	24000 - 240000	24.0 - 240.0
6.0" IPS	250 - 2500	15000 - 150000	360000 - 3600000	900 - 9000	54000 - 540000	54.0 - 540.0
8.0" IPS	400 - 4000	24000 - 240000	575000 - 5750000	1500 - 15000	90000 - 900000	90.0 - 900.0
10.0" IPS	600 - 6000	36000 - 360000	865000 - 8650000	2200 - 22000	132000 - 1320000	132 - 1320
12.0" IPS	800 - 8000	48000 - 480000	1150000 - 11500000	3000 - 30000	180000 - 1800000	180 - 1800

GPM = Gallons Per Minute
 LPM = Liters Per Minute
 OZM = Ounces Per Minute

GPH = Gallons Per Hour
 LPH = Liters Per Hour
 M3H = Cubic Meters per

Hour
 GPD = Gallons Per Day
 LPD = Liters Per Day

6.0 MOUNTING OPTIONS

Rotating Display

Step 1: Remove Two Screws

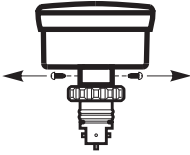

Step 2: Rotate 90°

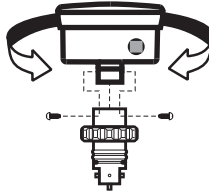

Step 3: Re-attach Screws

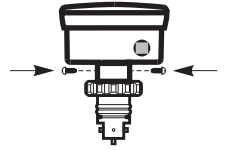

Fig. 6

Angle Mount on Horizontal Pipe

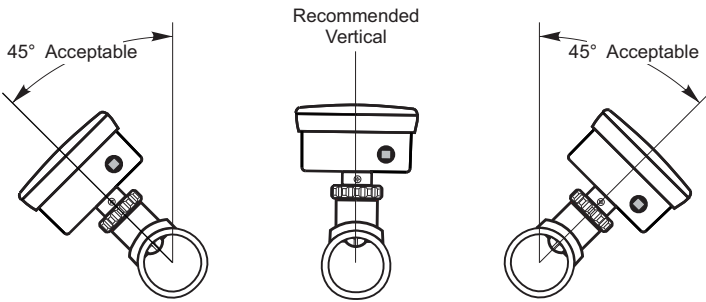

Fig. 7

Panel Mount

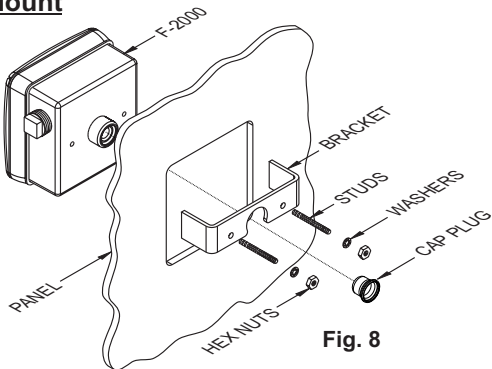

Fig. 8

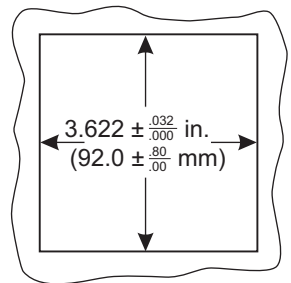

Fig. 9

Optional Pipe and Wall Mount Adapter Kit

Wall Mount

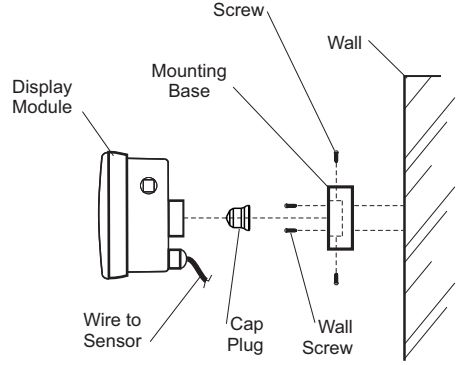
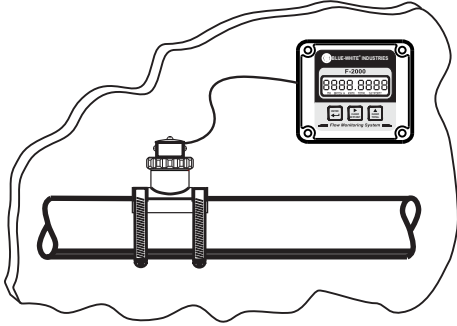

Fig. 10

Pipe Mount

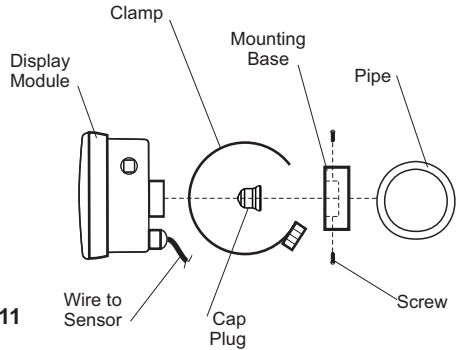
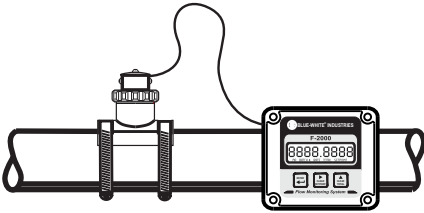

Fig. 11

Ordering Information

Kit Number	Description
71000-301	Wall Mount Kit
71000-302	Pipe Mount Kit for 1-1/2" pipe
71000-303	Pipe Mount Kit for 2" pipe
71000-304	Pipe Mount Kit for 3" pipe
71000-305	Pipe Mount Kit for 4" pipe
71000-306	Pipe Mount Kit for 6" pipe
71000-307	Pipe Mount Kit for 8" pipe
71000-414	Pipe Mount Kit for 10" pipe
71000-415	Pipe Mount Kit for 12" pipe

7.0 F-2000 Electrical Wiring Connections

7.1 Enclosure knock-out Instructions

Option A: Conduit Connection

1. Remove the red cap plug.
2. Install your pipe fitting (1/2 - 14 NPT male end).

Option A:

1/2-14 MPT Red Cap Plug (for pipe fitting)

Option B: Liquid-Tight Connections

1. Remove knock-out(s) using a screwdriver.
2. Trim edge(s) with a knife and remove sharp edges.
3. Install the provided liquid-tight connector(s).

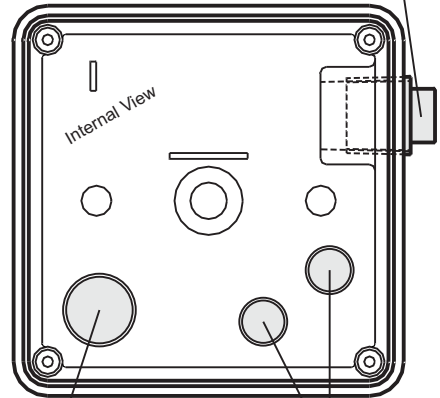

Option B:

3/4 DIA. Knock-out (large liquid-tight connector)

Option B:

1/2 DIA. Knock-out (small liquid-tight connector)

Notes:

For the large liquid-tight connector (3/4" knock-out), the acceptable cable diameter is between .200 - .394 in (5.1 - 10.0 mm).

For the small liquid-tight connector (1/2" knock-out), the acceptable cable diameter is between .118 - .255 in (3.0 - 6.5 mm).

7.2 Optional Circuit Board Installation

CAUTION: DISCONNECT POWER SOURCE BEFORE SERVICING.

1. Carefully align optional board's Pin Header with the Pin Header socket located on the main circuit board.
2. Press firmly into place.
3. Secure the board with the two screws provided.

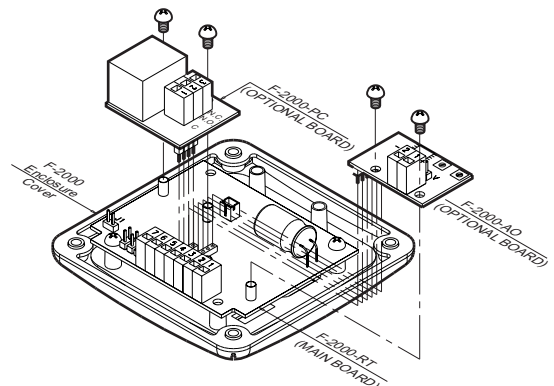

7.3 Model RT Circuit Board Wiring

CAUTION: DISCONNECT POWER SOURCE BEFORE SERVICING.

Jumper Configuration

Jumpers	Function
J1 Installed	Battery Input (4 - 1.5 VDC, AA Cells)
J1 Left Open	Plug-In Transformer (115 VAC/15 VDC, 220 VAC/15 VDC, 230 VAC/15 VDC)
J2 Installed	Front Panel Programming is Disabled
J2 Left Open	Front Panel Programming is Enabled (factory default)
J3 Installed and J4 Left Open	Hall Effect Sensor and Micro-Flow Sensor Input
J3 Left Open and J4 Installed	AC Coil Sensor Input

Terminal Configuration

	Terminal	Function
Supply power input	6	Positive (+) power input (red wire from battery pack, or black with stripe wire from 15 VDC plug-in transformer)
	5	Ground (-) power input (black wire from battery pack or 15 VDC plug-in transformer)
AC coil sensor input	2	Ground (-) input (black wire from coil sensor body)
	3	Pulse input (yellow or red wire from coil sensor body)
Hall Effect sensor input	1	Positive (+) input (red wire from hall effect sensor)
	2	Ground (-) input (black wire from hall effect sensor)
	3	Pulse input (bare wire from hall effect sensor)
Micro-Flo sensor input	1	Positive (+) input (red wire from hall effect sensor)
	2	Ground (-) input (black wire from Micro-Flo sensor or negative (-) output from Micro-Flo display circuit board)
	3	Pulse input (bare wire from Micro-Flo sensor or positive (+) output from Micro-Flo display circuit board)
Open connector pulse output (from sensor)	7	NPN positive (+) signal output (Max voltage: 30VDC, Max load: 15mA, 2k ohm pull-up recommended.)
	4	NPN negative (-) signal output

F-2000 RT Board

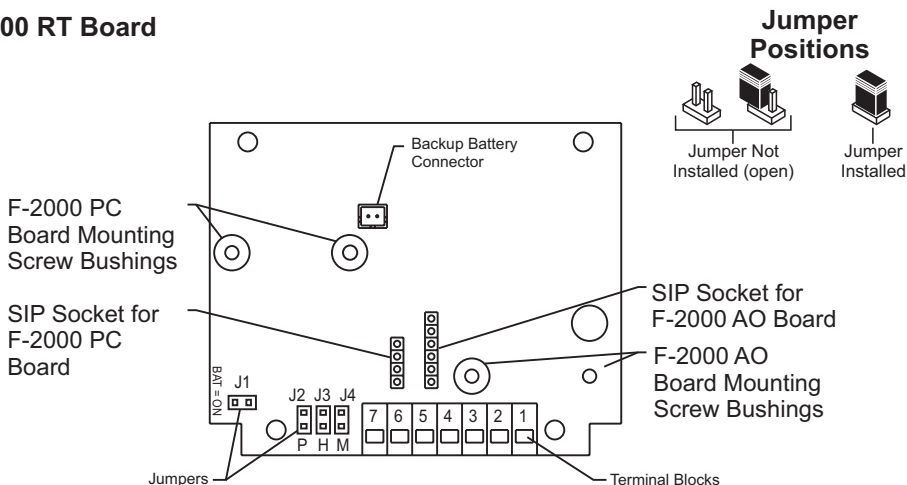

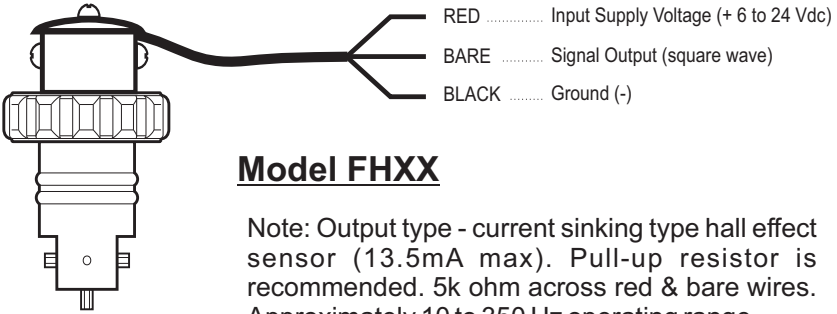
7.4 Model FHXX and FCXX Sensor wiring**Model FHXX**

Note: Output type - current sinking type hall effect sensor (13.5mA max). Pull-up resistor is recommended. 5k ohm across red & bare wires. Approximately 10 to 350 Hz operating range.

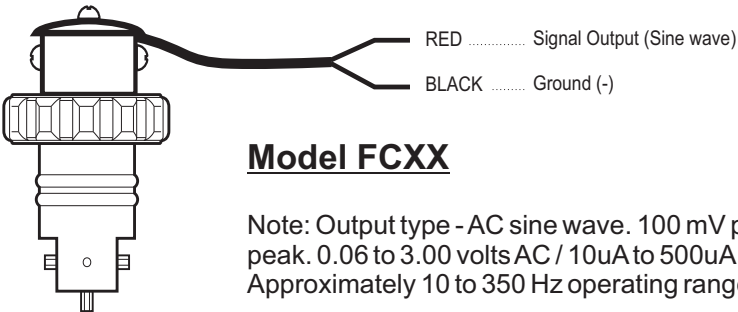
**Model FCXX**

Note: Output type - AC sine wave. 100 mV peak to peak. 0.06 to 3.00 volts AC / 10uA to 500uA AC. Approximately 10 to 350 Hz operating range.

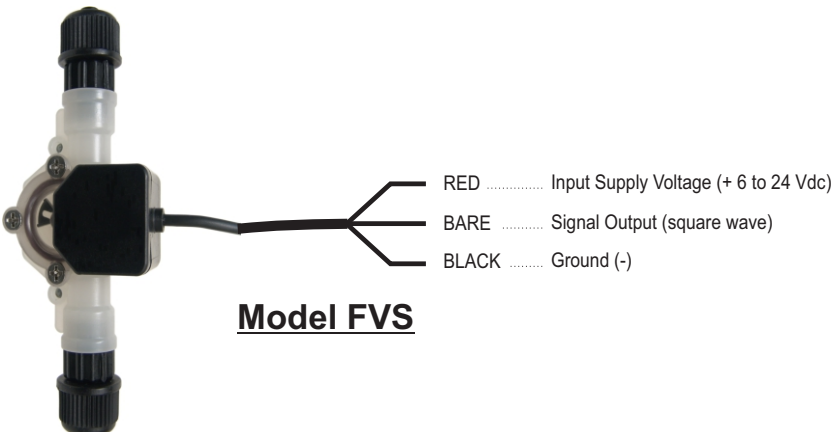
**Model FVS**

8.0 HOW TO OPERATE THE F-2000

8.1 *Theory of Operation*

The MODEL RT is the base unit of the F-2000 flow monitoring system. Fluid flowing through the pipe causes the paddlewheel to spin. Pulses generated by the spinning paddlewheel are counted and multiplied by scaling factors. The resulting flow rate amounts and total flow amounts are displayed on the LCD readout. Pressing the enter button located on the front panel toggles the display between flow rate and total flow or allows entry into the programming mode. Pressing the clear total button while the total flow value is displayed will return the total to zero (must be activated in the programming mode - not the factory default setting). A small icon will light at the bottom of the LCD indicating the mode being displayed.

The MODEL PC includes all of the features of the MODEL RT as well as a relay which can be used to switch external electrical equipment when user programmed setpoints are reached. The relay must be assigned to respond to either the rate value for rate alarm applications (rate mode), or to the total value for batching or proportional feed applications (batch mode). Only one may made be used at any one time. When assigned to the batch mode, the display can be toggled to show four different values, the rate of flow, total flow, current batch number or current batch total, by pressing the enter button located on the front panel. A small icon will light at the bottom of the LCD display indicating the mode being displayed. The model PC is described in a separate instruction manual.

The MODEL AO includes all of the features of the MODEL RT as well as a 4-20mA or 0-10VDC output signal which is proportional to the flow rate value. This mode is always active although the output value can not be displayed on the LCD. A small icon will light indicating the mode is active. The model AO is described in a separate instruction manual.







The MODEL AP includes the features of all three F-2000 models, the RT, PC, and AO.

8.2 How To Operate The MODEL RT

8.2.1 What Was The MODEL RT Designed To Do?

- Display the rate of flow up to eight digits.
- Display the total amount of flow up to eight digits.
- Output an open collector signal (NPN) that is proportional to the flow rate. Operates by batteries or plug-in AC transformer.
- Greater than 1 year battery life.
- Front panel user programmable.
- Front panel programming can be disabled for security.
- Front panel total reset can be disabled for security.
- Programmable battery saving mode. (Screen blanks after 30seconds)
- Programmable decimal point locations for both rate and total modes.
- Display can be mounted on the sensor or panel mounted (1/4 DIN). See figure 6 and 8.
- Display can be rotated on sensor. See figure 6.
- Display can be mounted on a pipe or wall with optional mounting bracket kit. See figure 8 - 11.
- Display can be panel mounted up to 250 ft. from sensor when used with AC coil sensor.
- Display can be panel mounted up to 1 mile from sensor when used with Hall Effect sensor.
- Optional circuitry, AO (analog output) and PC (process control) boards, can be field installed at a later time.

8.2.2 What Features Are Available On The MODEL RT?

- Press  to toggle between RATE and TOTAL display modes. The icon will light to indicate the active mode. 
- Press and hold  for at least 1.25 seconds to enter the programming mode. Allow twenty seconds to pass so the display will switch back to the readout mode. See section 7.1. 
- While the TOTAL mode is displayed, press  to reset the total amount to zero. (Must be enabled in the program mode - see page 16, step 6.) 

8.2.3 How Do I Determine My Calibration Numbers?

When ordered as a complete system, the F-2000 MODEL RT is factory programmed to the flow range you specified when you placed your order. See section 4.0 for various flow ranges.

Note: The F-2000 model AO and PC functions will *always* require field programming. All F-2000 models will require field programming when components are purchased separately. See section 7.2 and 7.3.

The following screens are used to input the calibration constants and to turn on or off the various features of the MODEL RT. The MODEL RT has six different input screens. They are listed in the table below.

Screen No.	Programming Functions
RATE 1	Input flow Rate Scale Factor - (S_r)
RATE 2	Input flow rate display Decimal Point Factory - (D_r)
RATE 3	Toggle Battery Saving mode - on / off (factory default: off)
TOTAL 1	Input flow Total Scale Factor - (S_t)
TOTAL 2	Input total flow display Decimal Point Factor - (D_t)
TOTAL 3	Toggle front panel Clear Total button on (enabled) /off (disabled) - (factory default: off)

Before programming the unit, the following calibration constants must be determined. Remember, when purchased as a complete system, the model RT is pre-programmed at the factory. No further programming is necessary.

Input flow rate display Decimal Point Factory - (D_r)

Step 1 Where would you like your displayed flow rate decimal point located?Desired Location = D, (Decimal Rate Factor) *Note: Four decimal places max.*

XXXXXX = 1

XXXX.X = 10

XXX.XX = 100

XX.XXX = 1000

X.XXXX = 1000

Enter your D, here.

Step 2 What time factor would you like to use in your measurement?

Example: Per Minute = 60 seconds

Per Hour = 3600 seconds

Per Day = 86400 seconds Enter seconds here.

Step 3 To determine your flow rate K-Factor, the following information is needed.a. What size pipe are you going to install this meter on? inch pipeb. What schedule pipe are you using? Sch 40 or Sch 80 or Inlinec. What is your flow range? Low Flow or Standard Flow (refer to pages 16 & 17)

d. Using the data you specified above, locate your K-Factor from the correct table. Pages 16 & 17.

e. What is your K-Factor?

f. If you are going to be using gallons as your unit of measure, you can go directly to Step 4.

g. To convert K-Factor to other units of measure, use the following formulas:

Ounces = K-factor ÷ 128

Liters = K-factor ÷ 3.785

Cubic Meters = K-factor ÷ 0.003785

Write your new K-Factor number here. **Example:** To convert 2" schedule 80 gallons K-factor to liters, you will use the following formula:*Note: Locate your K-factor off the table on pages 16 & 17..*

$$\frac{58.82 \text{ (K-factor)}}{3.785} = 15.54$$

Your new liters K-factor is 15.54

Step 4 Calculate your Rate Scale Factor (S_r) using the following formula.

D_r from **Step 1**, Seconds from **Step 2**, K-Factor from **Step 3**.

$$S_r = \frac{D_r \times \text{Seconds}}{\text{K-Factor}}$$

Example:

D _r	= 10	S _r = $\frac{10 \times 3600}{63.52}$
Seconds	= 3600	S _r = $\frac{36000}{63.52}$
K-Factor	= 63.52	S _r = 566.751

Write your S_r (Rate Scale Factor) number here.

Step 5 Where would you like your displayed accumulated Total Decimal (D_i) point located?

Desired Location = D_i (Total Decimal Factor) *Note: Four decimal places maximum.*

- XXXXX = 1
- XXXX.X = 10
- XXX.XX = 100
- XX.XXX = 1000
- X.XXXX = 10000

Enter your D_i here

Step 6 Determine your Total K-factor.

Your Total K-factor and Flow Rate K-factor are the same if the same units (i.e., Gallons, liters, etc.) Are displayed for both. However, you can use a different unit of measure for your total display. Follow the instructions in **step 3-g** to convert to a different Total K-factor unit. Write your Total K-factor here.

Step 7 Calculate your Total Scale Factor (S_t) using the following formula.

$$S_t = \frac{D_t}{K}$$

Example:

$$S_t = \frac{D_t}{K}$$

$$S_t = \frac{1}{58.82}$$

$$S_t = 00.0170$$

Note: The Total Scale Factor may be carried out to four decimal places.







Write your Total Scale Factor (S_t) here.

8.2.4 How Do I Program The MODEL RT?

Note: While in the programming mode, if no buttons are pressed within twenty seconds, the programming mode is automatically exited without saving the input of the last screen. See page 18 for programming menu flow chart.



Step 1 Entering the Rate Scale Factor.



- Press and hold down  for at least 1.25 seconds.
- Enter the Rate Scale Factor (Sr from Step 4, page 14).
- Press  to select the digit to be modified or the decimal point.
- Press  to modify the selected digit. Repeat the process until all digits have been modified. Note: The selected digit will blink to notify you it is selected.
- Press  to proceed to the last digit. Press  once more and the digits will stop flashing.
- Press  once to see the decimal point appear. Press repeatedly until the decimal point is located in the desired location.
- When finished, press . This will move you to the RATE 2 screen.



Step 2 The Rate Decimal Point Location screen.



- Press  once to see the decimal point appear. Press repeatedly until the decimal point is located in the desired location. Then press  to move you to RATE 3.
- This value should match Page 13, Step 1, desired decimal location. (Example 0000.0)





Step 3 The Battery Save Mode On / Off screen. Factory default = OFF

- Press  to toggle the ON and OFF settings. Press  once you've selected your setting.



Step 4 The Total Scale Factor screen is selected.



- Enter the Total Scale Factor (S_i from Step 7, page 14).
- Press  to select the digit to be modified or the decimal point.
Note: The selected digit will blink to notify you it is selected.
- Press  to modify the selected digit or the decimal point. Repeat until all digits have been Entered. When finished, press . This will move you to the TOTAL 2 screen.



Step 5 The Total Decimal Point screen is selected.



- The Total 2 screen is where you enter your Decimal Point Factor for your totalizer.
- Use the information you calculated on D_i , on Page 14, Step 5. Move the decimal point by pressing the  until the decimal point is in the desired location.
- Then press . (Example 00000)

Step 6 The Front Panel Clear Total Button Enable / Disable screen is selected. Factory default = OFF (disabled)



- The Total 3 screen gives you the option to turn on or off the clear total button function. It was designed to prevent the user from making the mistake of clearing the totalizer screen. By pressing the  you can scroll through the on and off mode.
- Press  once you have made your selection.

Step 7 Exit the programming mode

- Press and hold down  for at least 1.25 seconds to exit the Programming mode.

8.2.5 Calibration Constants

Note: The values in the following tables are based on laboratory testing of nominal pipe dimensions. The F-2000 sensor is factory calibrated to $\pm 1\%$ of full scale linearity. Your actual accuracy will vary based on your pipe I.D. And other installation factors.

METRIC PIPE PN10 & PN16 (Meets DIN 8062)

Saddle Mount Models (Pipe Insertion connection)

Standard Flow Range - LPM (liters per minute)

Pipe Size (MM)	PN Rating	Pipe I.D. (MM)	Flow Range (LPM)	K-Factor (Pulse/L)	RATE 1		RATE 2		TOTAL 1		TOTAL 2	
					Rate Scale Factor (Sr) (LPM/Hz)	Rate Display Decimal Point (Dr)	Rate Scale Factor (Sr) (L/Pulse)	Rate Display Decimal Point (Dr)	Total Scale Factor (St) (L/Pulse)	Total Display Decimal Point (Dt)	Total Scale Factor (St) (L/Pulse)	Total Display Decimal Point (Dt)
50	10	45.2	70.0 - 700.0	16.561	36.2297	0000.0	00.0604	00000				
50	16	42.6	70.0 - 700.0	20.719	28.9588	0000.0	00.0483	00000				
63	10	57.0	110 - 1100	10.522	05.7023	00000	00.0950	00000				
63	16	53.6	110 - 1100	11.830	05.0720	00000	00.0845	00000				
75	10	67.8	150 - 1500	9.2155	06.5108	00000	00.1085	00000				
75	16	63.8	150 - 1500	10.3557	05.939	00000	00.0966	00000				
90	10	81.4	230 - 2300	5.294	11.3335	00000	00.1889	00000				
90	16	76.6	230 - 2300	5.944	10.0944	00000	00.1682	00000				
110	10	99.4	350 - 3500	2.942	20.3969	00000	00.3399	00000				
110	16	93.6	350 - 3500	3.107	19.3133	00000	00.3219	00000				
160	10	144.6	720 - 7200	1.386	43.2782	00000	00.7213	00000				
160	16	136.2	720 - 7200	1.574	38.1081	00000	00.6351	00000				
200	10	180.8	1150 - 11500	0.927	64.7077	00000	01.0785	00000				
200	16	170.2	1150 - 11500	1.008	59.5501	00000	00.9925	00000				
250	10	226.2	1700 - 17000	0.565	106.232	00000	01.7705	00000				
315	10	285.0	2700 - 27000	0.353	170.003	00000	02.8334	00000				

I.P.S. PIPE (Meets ASTM-D-1785)

Molded Inline Bodies (Male NPT connection)

3/8" - 1" pipe sizes - Standard Range #1 - GPM (gallons per minute)

Pipe Size (in.)	Pipe Sch.	Body I.D. (In.)	Flow Range (GAL/Min)	K-Factor (Pulse/GAL)	RATE 1		RATE 2		TOTAL 1		TOTAL 2	
					Rate Scale Factor (Sr) (GPM/Hz)	Rate Display Decimal Point (Dr)	Rate Scale Factor (Sr) (GAL/Pulse)	Rate Display Decimal Point (Dr)	Total Scale Factor (St) (GAL/Pulse)	Total Display Decimal Point (Dt)	Total Scale Factor (St) (GAL/Pulse)	Total Display Decimal Point (Dt)
3/8	Inline	0.375	.800 - 8.000	1456.31	41.2000	00.000	00.0069	0000.0				
1/2	Inline	0.500	2.00 - 20.00	1034.48	05.8000	000.00	00.0097	0000.0				
3/4	Inline	0.660	3.00 - 30.00	612.25	09.8000	000.00	00.0163	0000.0				
1.0	Inline	0.840	5.00 - 50.00	338.60	17.7200	000.00	00.0295	0000.0				

3/8" - 1" pipe sizes - Low Range #2 - GPM (gallons per minute)

Pipe Size (in.)	Pipe Sch.	Body I.D. (In.)	Flow Range (GAL/Min)	K-Factor (Pulse/GAL)	RATE 1		RATE 2		TOTAL 1		TOTAL 2	
					Rate Scale Factor (Sr) (GPM/Hz)	Rate Display Decimal Point (Dr)	Rate Scale Factor (Sr) (GAL/Pulse)	Rate Display Decimal Point (Dr)	Total Scale Factor (St) (GAL/Pulse)	Total Display Decimal Point (Dt)	Total Scale Factor (St) (GAL/Pulse)	Total Display Decimal Point (Dt)
3/8	Inline	0.218	.400 - 4.000	2926.83	20.5000	00.000	00.0034	0000.0				
1/2	Inline	0.250	.500 - 5.000	2419.35	24.8000	00.000	00.0041	0000.0				
3/4	Inline	0.375	.800 - 8.000	1518.99	39.5000	00.000	00.0066	0000.0				
1.0	Inline	0.500	2.00 - 20.00	1034.48	05.8000	000.00	00.0097	0000.0				

Molded Inline Bodies (Male NPT connection) - continued

1-1/2" - 2" pipe sizes - GPM (gallons per minute)

Pipe Size (in.)	Pipe Sch.	Flow Range #	Flow Range (GAL/Min)	K-Factor (Pulse/GAL)	RATE 1		RATE 2		TOTAL 1		TOTAL 2	
					Rate Scale Factor (Sr) (GPM/Hz)	Rate Display Decimal Point (Dr)	Rate Scale Factor (Sr) (GPM/Hz)	Rate Display Decimal Point (Dr)	Total Scale Factor (St) (GAL/Pulse)	Total Display Decimal Point (Dt)	Total Scale Factor (St) (GAL/Pulse)	Total Display Decimal Point (Dt)
1-1/2	Inline	1	4.00 - 40.00	466.20	12.8700	000.00	00.0215	0000.0				
1-1/2	Inline	2	6.00 - 60.00	192.93	31.0994	000.00	00.0518	0000.0				
1-1/2	Inline	3	10.0 - 100.0	156.94	3.8231	0000.0	00.0637	0000.0				
2	Inline	1	4.00 - 40.00	468.75	12.8000	000.00	00.0213	0000.0				
2	Inline	2	6.00 - 60.00	196.40	30.5499	000.00	00.0509	0000.0				
2	Inline	3	10.0 - 100.0	162.16	3.7000	0000.0	00.0617	0000.0				
2	Inline	4	20.0 - 200.0	67.416	8.9000	0000.0	00.1483	0000.0				

Saddle Models (Pipe insertion connection)

Standard Flow Range - GPM (gallons per minute)

Pipe Size (in.)	Pipe Sch.	Pipe I.D. (in.)	Flow Range (GAL/Min)	K-Factor (Pulse/GAL)	RATE 1		RATE 2		TOTAL 1		TOTAL 2	
					Rate Scale Factor (Sr) (GPM/Hz)	Rate Display Decimal Point	Rate Scale Factor (Sr) (GPM/Hz)	Rate Display Decimal Point	Total Scale Factor (St) (GAL/Pulse)	Total Display Decimal Point (Dt)	Total Scale Factor (St) (GAL/Pulse)	Total Display Decimal Point (Dt)
1.5	40	1.610	15.0 - 150.0	86.580	06.9300	0000.0	00.0116	00000				
1.5	80	1.500	15.0 - 150.0	102.04	05.8800	0000.0	00.0098	00000				
2.0	40	2.067	30.0 - 300.0	50.850	11.7994	0000.0	00.0197	00000				
2.0	80	1.939	30.0 - 300.0	58.820	10.2006	0000.0	00.0170	00000				
2.5	40	2.469	40.0 - 400.0	34.8635	17.2010	0000.0	00.0287	00000				
2.5	80	2.323	40.0 - 400.0	39.200	15.3061	0000.0	00.0255	00000				
3.0	40	3.068	60.0 - 600.0	21.820	27.4977	0000.0	00.0458	00000				
3.0	80	2.900	60.0 - 600.0	24.000	25.0000	0000.0	00.0417	00000				
4.0	40	4.026	100 - 1000	11.8577	05.0600	00000	00.0843	00000				
4.0	80	3.826	100 - 1000	12.7659	04.7000	00000	00.0783	00000				
6.0	40	6.065	250 - 2500	5.3507	11.2135	00000	00.1869	00000				
6.0	80	5.761	250 - 2500	5.5738	10.7647	00000	00.1794	00000				
8.0	40	7.981	400 - 4000	2.985	20.1000	00000	00.3350	00000				
8.0	80	7.625	400 - 4000	2.940	20.4082	00000	00.3401	00000				
10.0	40	10.020	600 - 6000	1.594	37.6412	00000	00.6274	00000				
10.0	80	9.564	600 - 6000	1.845	32.5203	00000	00.5420	00000				
12.0	40	11.938	800 - 8000	1.116	53.7634	00000	00.8961	00000				
12.0	80	11.376	800 - 8000	1.296	46.2963	00000	00.7716	00000				

PVC Tee (Solvent weld connection)

1" - 3" pipe sizes - GPM (gallons per minute)

Pipe Size (in.)	Pipe Sch.	Pipe Type	Flow Range (GAL/Min)	K-Factor (Pulse/GAL)	RATE 1		RATE 2		TOTAL 1		TOTAL 2	
					Rate Scale Factor (Sr) (GPM/Hz)	Rate Display Decimal Point (Dr)	Rate Scale Factor (Sr) (GPM/Hz)	Rate Display Decimal Point (Dr)	Total Scale Factor (St) (GAL/Pulse)	Total Display Decimal Point (Dt)	Total Scale Factor (St) (GAL/Pulse)	Total Display Decimal Point (Dt)
1"	Inline	PVC	6.00 - 60.00	267.860	22.3998	00.000	00.0373	0000.0				
1-1/2"	Inline	PVC	15.0 - 150.0	94.0400	6.3803	000.00	00.0106	0000.0				
2"	Inline	PVC	30.0 - 300.0	53.1600	11.2867	000.00	00.0188	0000.0				
3"	Inline	PVC	60.0 - 600.0	20.69	29.000	000.00	00.0483	0000.0				

PVC Tee (Solvent weld connection)

1" - 2" pipe sizes - LPM (liters per minute)

Pipe Size (in.)	Pipe Sch.	Pipe Type	Flow Range (LPM)	K-Factor (Pulse/L)	RATE 1		RATE 2		TOTAL 1		TOTAL 2	
					Rate Scale Factor (Sr) (GPM/Hz)	Rate Display Decimal Point (Dr)	Rate Scale Factor (Sr) (GPM/Hz)	Rate Display Decimal Point (Dr)	Total Scale Factor (St) (GAL/Pulse)	Total Display Decimal Point (Dt)	Total Scale Factor (St) (GAL/Pulse)	Total Display Decimal Point (Dt)
1"	Inline	PVC	25.0 - 250.0	70.7613	8.4792	00.000	00.1413	0000.0				
1-1/2"	Inline	PVC	60.0 - 600.0	24.8428	24.1519	000.00	00.0403	0000.0				
2"	Inline	PVC	100.0 - 1000.0	14.0434	4.2725	000.00	00.0712	0000.0				

PVC Tee (Solvent weld connection)

1" - 2" pipe sizes - M3H (cubic meters per hour)

Pipe Size (in.)	Pipe Sch.	Pipe Type	Flow Range (M3H)	K-Factor (Pulse/M3)	RATE 1		RATE 2		TOTAL 1		TOTAL 2	
					Rate Scale Factor (Sr) (GPM/Hz)	Rate Display Decimal Point (Dr)	Rate Scale Factor (Sr) (GPM/Hz)	Rate Display Decimal Point (Dr)	Total Scale Factor (St) (GAL/Pulse)	Total Display Decimal Point (Dt)	Total Scale Factor (St) (GAL/Pulse)	Total Display Decimal Point (Dt)
1"	Inline	PVC	1.5 - 15.0	70761.35	5.0875	00.000	00.0014	0000.0				
1-1/2"	Inline	PVC	3.6 - 36.0	24842.82	14.4911	000.00	00.0040	0000.0				
2"	Inline	PVC	6.0 - 60.0	14043.43	25.6348	000.00	00.0071	0000.0				

8.3 Programming Menu Flow Chart

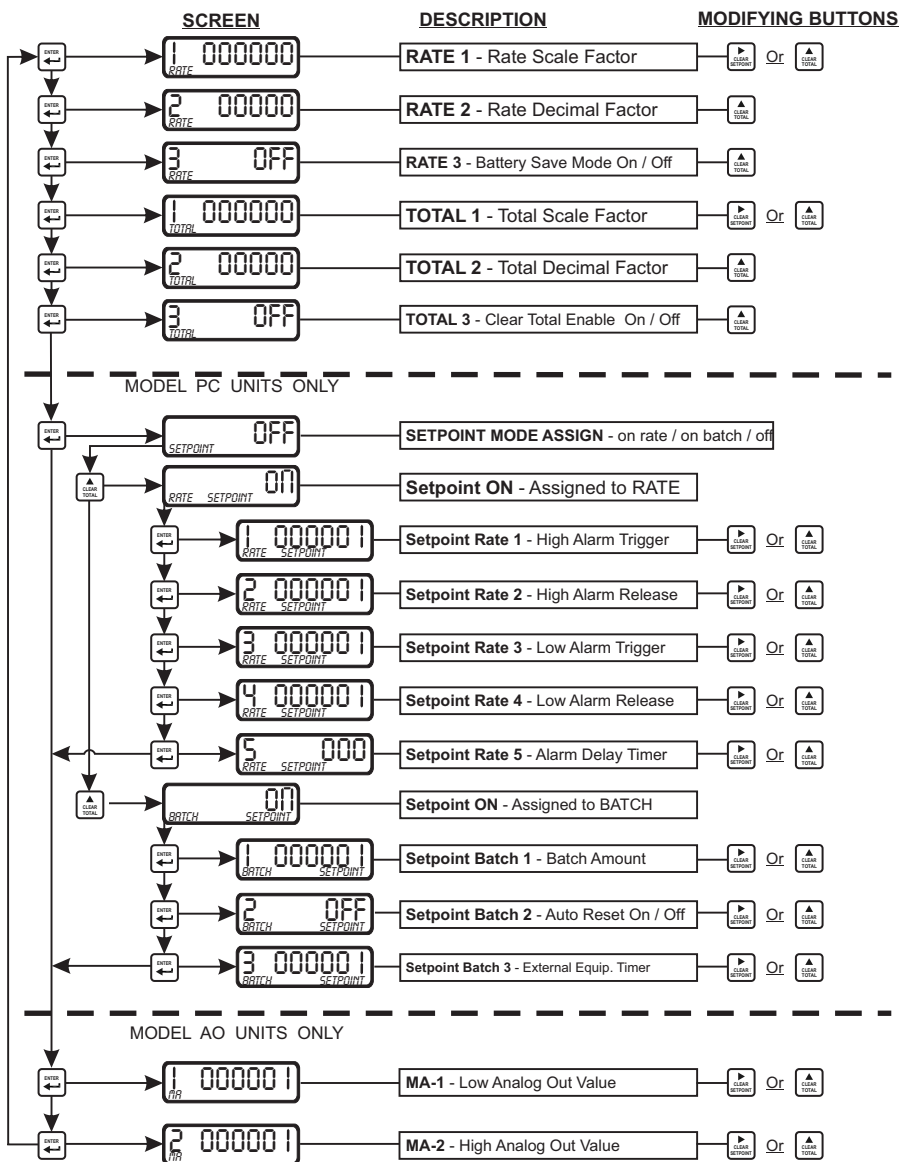

9.0 MAINTENANCE

The F-2000 requires very little maintenance, however, some conditions will cause increased wear or possible damage to the unit.

- Periodically remove the sensor assembly from the pipe fitting and inspect the meter for signs of wear and obstructions. Clean the paddle of any foreign objects. Replace the paddle and axle if worn.
- Although the meter is capable of operating at the high end of the flow range, continuous use at very high flow rates (upper 25% of the calibrated flow range), is not recommended. The paddle and axle life is related to the rate of flow and the fluid being measured. Corrosive fluids moving at high flow rates will cause increased wear requiring frequent inspection and maintenance. Ceramic, titanium or nickel axles are available for extreme corrosive environments.
- Although the F-2000 is designed to withstand outdoor conditions, a cool, dry location where the unit can be easily serviced is recommended. **The life of the LCD display will be severely reduced when installed in direct sunlight. Do not install the meter so that the LCD is in direct sunlight.**
- O-rings should be inspected periodically. Immediately replace the o-rings at any sign of wear, swelling, cracking or discoloration.
- Battery operated models. Replace the four AA batteries every 12 months. The program memory will not erase when replacing the batteries. The unit will function normally for approximately 2 minutes while replacing the batteries. To replace the batteries, open the front panel of the enclosure by removing the four Phillips screws. After replacing the batteries, be sure the foam insert is in place before closing the front panel.
- Test the electronics by removing the sensor assembly from the pipe fitting and spinning the paddle by hand. If a reading does not appear in the display window, replace the batteries. If a reading still does not appear, the circuitry must be serviced by an authorized service center.

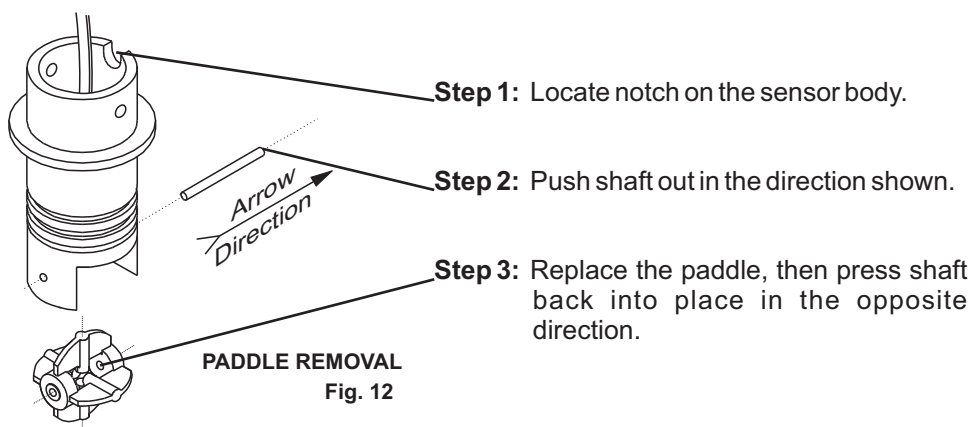

9.1 F-2000 Parts List

Item	Part Number	Description	Quantity
1	70000-783	Paddle assembly Kynar	1
2	90003-021	O-ring 022 Viton E60	2
3	90007-589	Axle PVDF	1
4	71000-238	Sensor body AC coil 1' cable	1
	71000-285	Sensor body AC coil 25' cable	1
	70000-806	Sensor body Hall effect 25' cable	1
5	90011-080	Screw #6-32 x .37 PH pan B 18/8	5
6	91001-280	Union nut	1
7	76000-628	Retainer sensor cap	1
8	90006-550	Cap sensor body SS	1
9	90012-208	Switch overlay F-2000	1
10	71000-356	Cover F-2000 w/ Switch overlay	1
11	90006-592	Gasket F-2000 housing neoprene	1
12	90010-227	Circuit board F-2000 RT	1
13	71000-311	Kit Circuitry model F-2000 AO	1
14	71000-316	Kit Circuitry model F-2000 PC	1
15	90011-155	Screw #6-32 x .31 PH pan SS	4
16	76001-149	Enclosure F-2000 sensor mount	1
	76001-150	Enclosure F-2000 panel mount	1
17	90006-593	Gasket F-2000 1/4 DIN panel mount	1
18	90008-331	Cap plug P-48 1/2 NPT red F-2000	1
19	71000-294	Kit F-2000 1/4 DIN panel mount	1
20	70000-500	Connector liquid-tight 1/2 in.	2
21	70000-589	Connector liquid-tight 3/4 in.	1
22	90008-332	Plug 1/2 in.	2
23	90008-340	Cap plug VTP-25 red	1
24	90011-038	Stud screw #10-32 1.62 long	2
25	90011-092	Star washer #10-32	2
26	90011-026	Hex nut #10-32	2
27	90008-333	Plug 7/8 in.	1
28	90013-222	Foam pad 1/4 in. thick	1

29	90008-254	Battery clip	1
30	90010-233	Battery holder F-2000 4x AA	1
31	90008-330	Battery alkaline AA	4
32	90008-336	Power supply 115VAC/15VDC	1
	90008-337	Power supply 220VAC/15VDC Europe	1
	71000-310	Power supply 230VAC/15VDC	1

9.2 F-2000 Exploded View

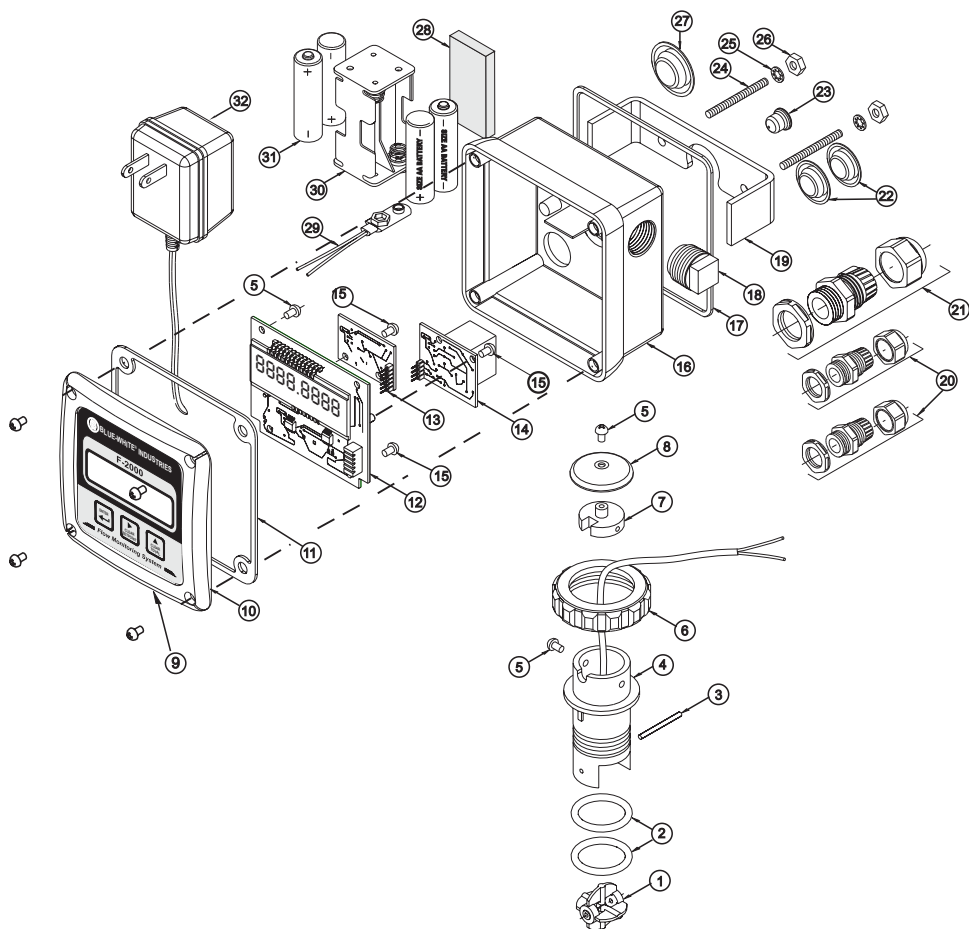

9.3 TROUBLESHOOTING

Situation	Cause	Solution
Leaking	Improper installation Worn or damaged o-rings	Pipe Fitting Manual pages 6 - 10 Pipe Fitting Manual pages 6 - 10
Flow rate reading is inaccurate	Improper installation Improper velocity profile Flow rate is out of range	Pipe Fitting Manual page 6 Pipe Fitting Manual page 4 Model RT Manual page 4
No display	Dead batteries Blocked paddle Damaged electronics Battery save mode is ON	Model RT Manual page 19 Pipe Fitting Manual page 7 Model RT Manual page 19 Model RT Manual page 18
Display shows zero flow	Improper alignment / installation Worn paddle and / or axle Damaged electronics	Pipe Fitting Manual page 7 Model RT Manual page 19 Model RT Manual page 19



Users of electrical and electronic equipment (EEE) with the WEEE marking per Annex IV of the WEEE Directive must not dispose of end of life EEE as unsorted municipal waste, but use the collection framework available to them for the return, recycle, recovery of WEEE and minimize any potential effects of EEE on the environment and human health due to the presence of hazardous substances. The WEEE marking applies only to countries within the European Union (EU) and Norway. Appliances are labeled in accordance with European Directive 2002/96/EC.

Contact your local waste recovery agency for a *Designated Collection Facility* in your area.

This page intentionally left blank.

BLUE-WHITE INDUSTRIES LIMITED WARRANTY

FLOWMETERS are warranted to be free of defects in material and workmanship for up to 12 months from the date of factory shipment. Warranty coverage is limited to repair or replacement of the defective flowmeter only. Blue-White Industries does not assume responsibility for any other damage that may occur.

This warranty does not cover damage to the flowmeter that results from misuse or alterations, nor damage that occurs as a result of: meter misalignment, improper installation, over tightening, use of non-recommended chemicals, use of non-recommended adhesives or pipe dopes, excessive heat or pressure, or allowing the meter to support the weight of related piping. Flowmeters are tested and calibrated with water only. Although meters may be suitable for other chemicals, Blue-White cannot guarantee their suitability.

Flowmeters are repaired at the factory only. Call or write the factory to receive a Return Authorization Number, carefully pack the flowmeter to be returned, including a brief description of the problem. Note the RA number on the outside of the carton.

Prepay all shipping costs. The factory does not accept COD Shipments. Damage that occurs during shipping is the responsibility of the sender.

***We are not satisfied
until you are!***

**ISO 9001:2015
CERTIFIED**



**MADE IN THE
USA**

80000-335

REV. 9 20210105

Blue-White
Industries, Ltd.

URL: www.Blue-White.com
E-mail: sales@blue-white.com
Techsupport@blue-white.com

Phone: 714-893-8529
Fax: 714-894-0149