

Self-Contained Hydrostatic Valve Assembly

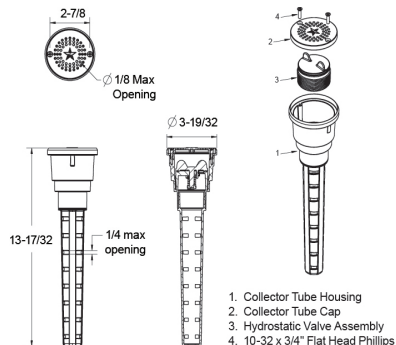

Part # HVCxxx

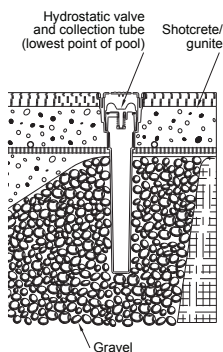







FEATURES

- Self-contained unit has a built-in collector tube
- Installs directly into the pool finish with no additional plumbing connection required
- Helps prevent swimming pool damage due to hydrostatic pressure beneath the pool shell when the pool is drained

12 per case

STANDARD COLORS

	HVC101		HVC104
	HVC102		HVC105
	HVC103		HVC108

HVC05xxx – Cap and Screws